

Sx Series

VERSATILE HANDHELD TEST AND MEASUREMENT
INCLUDING HYBRID IP/SDI & SDI EYE/JITTER ANALYSIS



*"The Sx is ideal for broadcast, live production
and video technology manufacturing..."*

Leader



Sx Series Overview

Handheld Signal Generation, Analysis and Monitoring

With over 8000 units shipped worldwide, the Sx range of instruments are the broadcast industry's most popular handheld devices offering exceptional mobility in an easy to use, easy to carry format. Designed for commissioning, fault-finding and compliance testing, the PHABRIX Sx range is equally at home on an outside broadcast, in a studio facility, in remote locations with remote monitoring, or in a manufacturing and test environment.

The proven lightweight (0.9Kg) but rugged aluminum case is fitted with a high quality screen for instrument display and video monitoring, as well as an integral speaker and headphone jack for audio monitoring. The generator/analyzer operates via rechargeable lithium battery for up to 2 hours, and can also be powered by a mains adaptor to offer flexible operation around facilities.

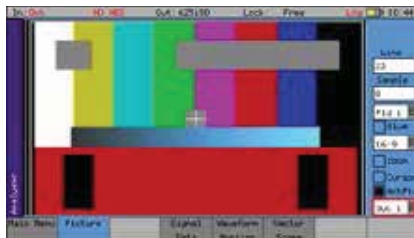

Extensive Video & Audio Toolset

With simultaneous signal generation and analysis, the built-in core diagnostic toolset includes a multi-format Waveform, Vectorscope and Video display with support for 16-channel audio monitoring.

Other key optional capabilities include AV delay measurement, bitstream generation and analysis of Dolby E, Dolby Digital and Dolby Digital Plus as well as data view, VANC/ANC inspector, status logging and remote operation over Ethernet.



Hybrid IP and SDI

The Sx TAG with its versatile SFP handles 3G/HD/SD-SDI, optical SDI, IP, HDMI and analog composite formats.

Comprehensive support is provided for modern broadcast IP systems with JT-NM Tested⁺ encapsulation and decapsulation of ST 2110-20/30/31/40 with IP to SDI gateway, ST 2059 PTP, AMWA NMOS IS-04, IS-05, and IS-08, as well as ST 2022-6.

Hybrid operation is supported with a built-in synchronizer that allows asynchronous SDI sources to be locked to PTP for ST 2110 encapsulation.

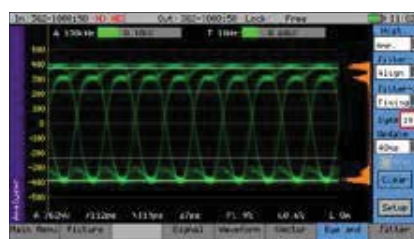

3G-SDI Real-Time Eye (RTE™) Physical Layer Testing

Ideal for SDI physical layer line check, commissioning and testing, the SxE is unique in offering rapid display and analysis of 3G/HD/SD-SDI physical interfaces with a sophisticated Real-Time Eye and Jitter measurement toolset.

⁺JT-NM Tested - For more details on the JT-NM Tested program at IBC 2019 and its test results please see https://jt-nm.org/jt-nm_tested

4x the flexibility

Unmatched flexibility, rapid fault finding

Sx TAG

- IP*/SDI/HDMI-OUT*
- IP Gateway*
- Optical*/Analog
- Video/Audio
- SD/HD/3G*
- AES/Dolby*
- Ref I/O



SxE

- Eye and Jitter
- Video/Audio
- SD/HD/3G
- AES/Dolby*
- Ref Input



SxA

- Video/Audio
- SD/HD/3G
- AES/Dolby*
- Ref Input



SxD

- Video/Audio
- Dual Link SDI
- SD/HD/3G
- Dolby*
- Ref Input



*Option

Common & Core Toolsets

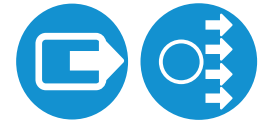

Generator



Video Generator†

- The Sx can create video test signals for all supported SD and HD SDI output standards including the 3GHz standards at 1080p/50/59/60 Y, Cb, Cr
- Advanced video formats include support for RGB, XYZ 12bit and 2K formats
- A fully programmable Y Zone Plate



Audio Generator†

- The Sx can embed an audio signal on all 16 embedded audio outputs
- The Audio Group menu controls which audio channels are present, signal type and amplitude
- Choice of: silence, adjustable tone, noise, AV Delay, Dolby test stream or AES input

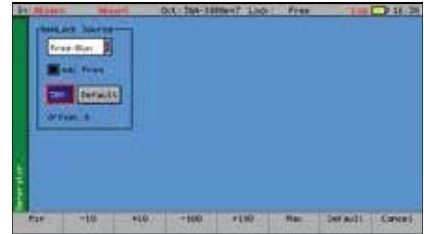

Reference†

- The Sx instrument can create video test signals that are either free-running or locked to a studio reference or input signal
- The Genlock menu is used to select the locking reference and provides a control for genlock phase offset in lines and pixels
- User control of Free Run frequency with +/- 100ppm pull range for SDI interface acceptance checking

Test Patterns

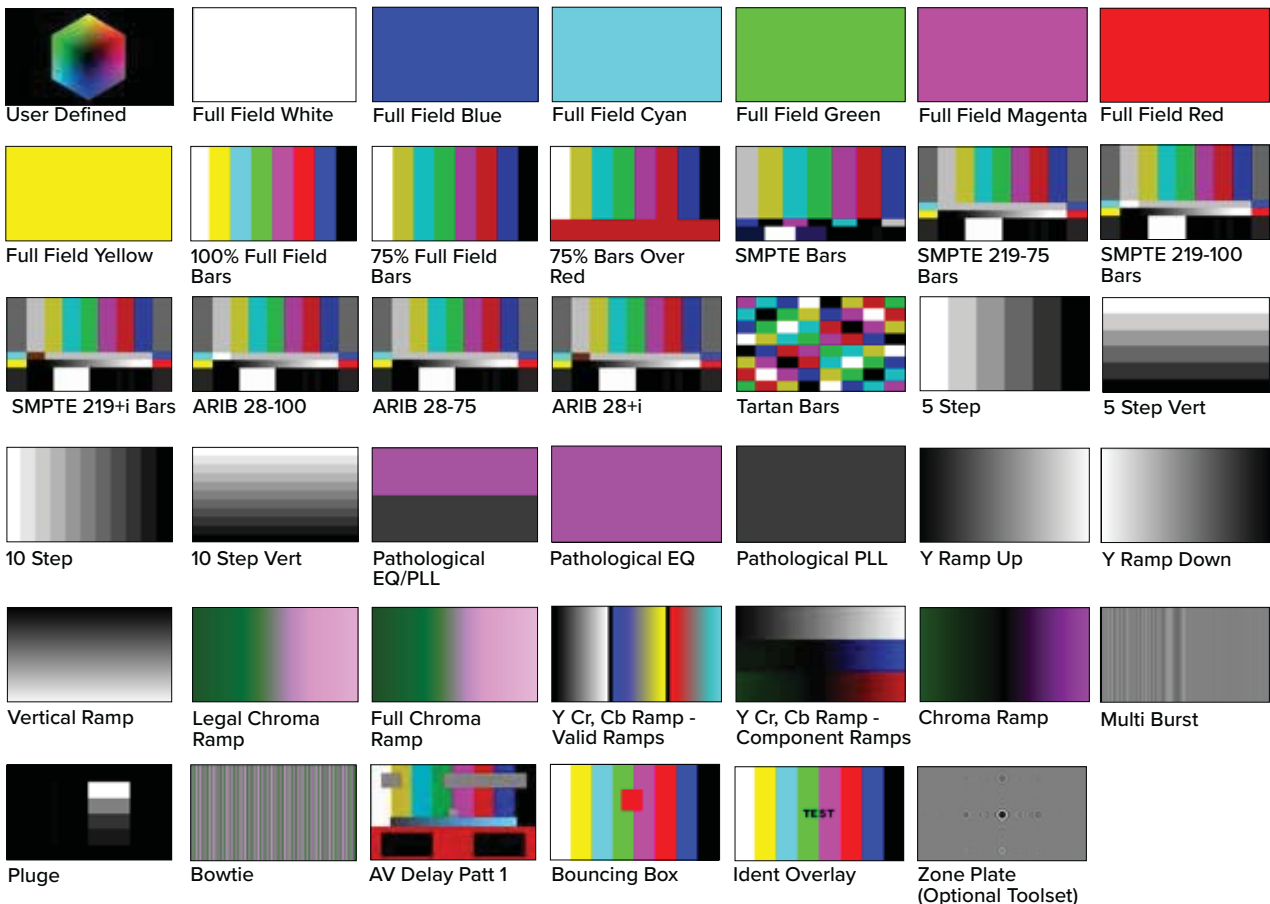

†Please note: Sx TAG units with serial numbers including and greater than #006376 will include the Composite and SD/HD SDI Generation toolset as standard. Sx TAG units with serial numbers including and less than #006375 do not have the Generator toolset as standard. The Generator toolset is available to purchase with option code PHSXO-GEN.

Common & Core Toolsets



Analyzer



Picture Monitor

- The picture is displayed in a window as a down-converted display
- A cursor may be turned ON over the area of the picture specified by the specified line and sample
- Monitor device input or output



Picture Zoom

- Zoom function provides a 1:1 unfiltered pixel view, centred on the position of the picture cursor
- HANC/VANC areas visible when cursor in blanking



Linked Cursors

- The picture cursor is linked to waveform, vectorscope and data views for rapid and accurate detailed measurement of the signal

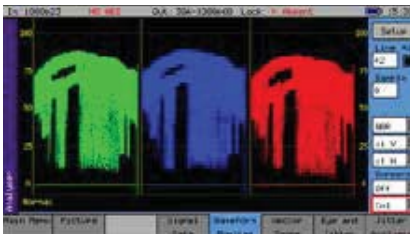

Waveform Full Frame

- Displays selected analyzer or generator source
- Analog locking reference input view (TAG only)
- YCbCr GBR, Y, Cb, Cr, R, G, B modes
- Cursors may be displayed over the waveform to allow measurement of time or amplitude values
- Vertical and horizontal magnifications

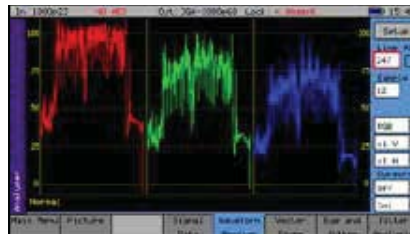

Waveform Line Select

- The display may be restricted to a single line or all lines may be displayed at the same time
- The single line display is linked to the picture, vectorscope and data view



Vectorscope

- Choice of 100% or 75% graticules
- Display the Composite, SDI, SFP video input or the generator test pattern
- Display a specific video line linked to picture cursor
- x1, x2, x5 or x10 magnifications with position to centre, cyan, yellow, green, magenta, red, blue graticule locations

Control



Screen Grab

- Screen grabs can be saved and downloaded via a web browser or FTP transfer



Web Browser

- View and control the instrument display over a TCP/IP interface with a standard browser
- Ideal for remote location checking, engineering support, and fault analysis
- Allows access to key functions including screen dumps, loudness files and logging files



PC Simulator

- A free Sx simulator PC application is available on the PHABRIX website
- Indicates command IDs for automation programming
- Simultaneous operation

Common & Core Toolsets



Audio

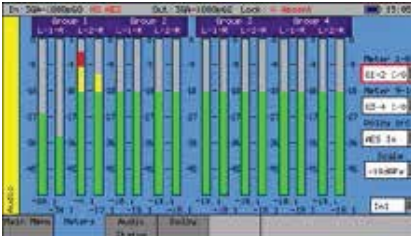

16 Channel Audio Meters

- Display up to 16 audio channels
- The source for each block of 8 meters may be independently set to allow metering of embedded audio inputs or outputs
- The current audio level in dBFs (decibels relative to 0dB full-scale) is displayed at the bottom of each meter



AES/Analog Audio Meters

- AES and Analog (TAG) audio metering available as an alternative to embedded audio
- Dolby E metering selection



Audio Channel Status

- The Audio Status menu shows the Channel Status for the selected audio channel
- Displayed in decoded form as well as a raw hexadecimal data dump
- The source may either come from the input signal or from the generator output for rapid comparison purposes

System



Instrument Presets

- Current settings in the Sx instrument can be saved as memories for future recall
- Memories can be exported to a single file, reimported or copied to other units
- Presets can be applied to the whole instrument or selectively within the Generator or Analyzer



Network Configuration

- The Network menu allows the Sx instrument to be configured as part of a network
- Support for automatic acquisition of network parameters via DHCP or manual configuration
- Remote control enable/disable and selection of port number



Software Status

- Serial number, Sx instrument MAC address, version information and battery state listed
- The date and time can be set and factory default settings recalled
- Display of loaded license options
- LCD brightness and screen saver configurations



Engineer Setup

- Manage the Sx settings including user access, clearing memories, factory default reset, software upgrades and audio calibration
- SDI input to SDI output loop through mode
- Control of SDI to IP-SFP gateway in Sx TAG



Utils

- Details of the unit's operating status
- Details the temperature and individual board voltages
- Lists any hardware errors that have been recorded

Common & Core Toolsets



Signal

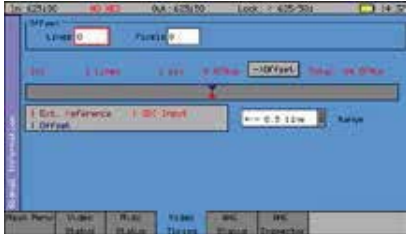

Video Timing

- Display the relationship between the selected video input with respect to the external reference input
- Offset feature to simplify system timing measurements



Video Status

- Display the status of the selected video input or output and any errors that have been found in the data stream
- Display of EDH, Active Picture and CRC data with cumulative run-time display of errors and error rate
- Display of estimated cable length for SDI inputs with selectable cable type



ANC Status

- Shows which ANC packets are present on the SDI input and whether any errors have been detected
- Each field is color coded according to whether the ANC packet is present (White), missing (Grey), has errors (Red), or has previously had errors (yellow)



Video Format/Payload ID

- The updated Misc Status menu provides an easy to read side by side status view of SMPTE 352 Video Payload Packets (VPID) embedded in the selected video input and displays any errors that have been found
- Support single links of multi-link 3G and HD based UHD formats
- Selection of input or output for rapid comparison
- Display of raw data and decoded form

Logging



Log Setup

- Set Audio Thresholds and log specific video status events, including Output, Reference and Input Status, TRS Errors, Picture CRC

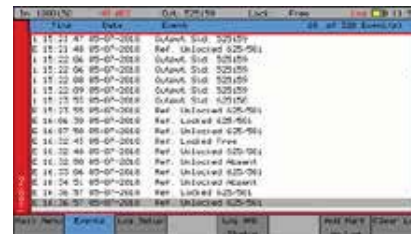

Event Log Display

- The Event Log menu displays a list of events with a time stamp showing when they occurred

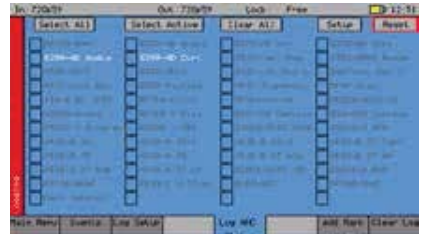

ANC Log Setup

- The Log ANC Status menu allows customization of which ANC packets to log for changes in status (e.g. Present, Checksum Error, Missing, Parity Error)
- Logging of Dolby and AES Status as well as device system errors
- Control of logging duration

Core Toolset SxE Only

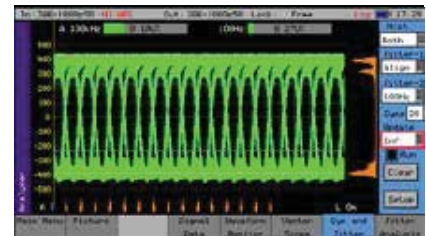
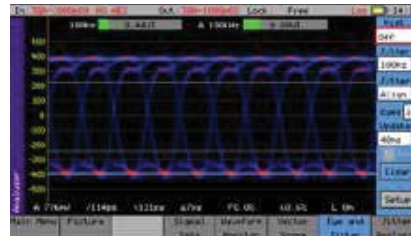
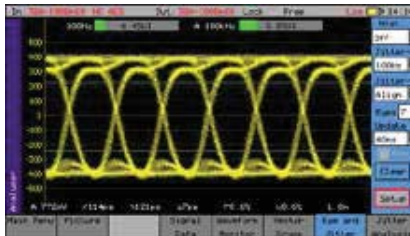

Automatic Eye and Jitter Measurements

- SxE offers instant, Real-Time Eye (RTE™) for rapid testing SMPTE SDI compliance and interoper issues
- SMPTE compliant automated measurements for rise time, fall time, delta, rise and fall overshoot and cable length
- Flexible display of between 1 to a maximum of 20 eyes with Amplitude and Time Histograms
- Selectable: Decade filters, Eye color for 'hot spot' view, two Jitter timing/UI thermometers with green/amber/red indication, 40ms or infinite Persistence, choice from 6 Cable types



Jitter Analysis

- The realtime Jitter analysis instrument enables an engineer to analyze the nature of jitter present on the SDI interface against time
- By analyzing jitter in this detailed way, an engineer can not only determine if a signal is in or out of specification, but also get a feel for where any problems lie. A spiky waveform could indicate power supply noise and these visual clues aid the diagnosis
- Selection of decade filter and jitter timing/UI thermometers is common to the Real-Time Eye Display so as to give consistent indication of the effect of the decade filter across the two instruments
- Line or Vertical Time base selection: 1 H, 2H, 1V, 1 Frame
- Vertical Gain controls: 0.1, 0.2, 0.5, 1.0 UI/division
- 40ms or infinite Persistence



Eye and Jitter Logging

- SxE's eye and jitter logging tools provide user-selectable logging of jitter thresholds in two different decade filters, and records of Rise and Fall times, Amplitude and rise and fall overshoot

Core Toolset Sx TAG Only



Composite Waveform

- The Waveform monitor can display the waveform of the composite analog inputs
- Selection of CVBS or Ref Input



Composite Chroma

- Waveform monitor can display the chroma component of the composite waveform



Composite Luma

- Waveform display of the low pass filtering of the composite waveform

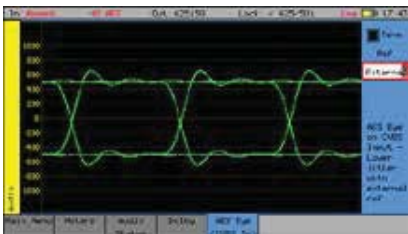

Audio AES Eye

- Real time monitoring of the 75Ω AES input
- This allows the amplitude and quality of the AES waveform to be seen
- Allows the relationship of the AES input to reference to be checked



SFP Status

- All the necessary status information for monitoring the health of the SFP and its interface

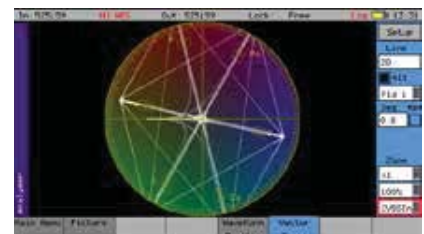

Vectorscope (Composite)

- Vectorscope view of the composite or external reference inputs

Sx TAG IP Only

2110 and In-band Control



NMOS

- AMWA NMOS IS-04 Discovery and Registration v1.2, IS-05 Connection Management v1.0 and IS-08 Audio Channel Mapping v1.0.1 (ST 2110)
- Automatic Registered Mode connection to a network registry service
- NMOS client can Browse Senders and Receivers, and drag and drop to make connections

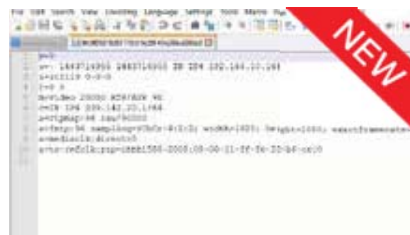

SDP and LLDP

- Generation and Reception of Session Description Protocol (SDP) records (ST 2110)
- Automatic transfer of Audio, Video and ANC Data flow parameters from sender to receiver
- Link Layer Discovery Protocol for SFP to switch connectivity and reporting

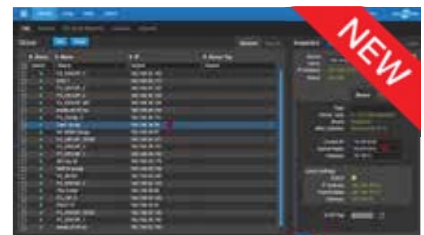

MN SET

- SFP can be controlled from either the Sx TAG GUI or inband over fiber using Riedel MN SET
- Remote SFP status monitoring, configuration and upgrade from a PC
- Rapid inspection of active SDP & flow formats
- Access to up to 8 Encap, 4 Decap Audio flows and 2022-7 Primary and Secondary flow configurations

Sx TAG Optional Toolset



TAG IP ST 2110/2022-6 Encap/Decap [PHSXO-IP]



ST 2110/ST 2059 PTP

- Selection of PTP Domain number and communication mode
- Indication of PTP lock status and version
- Reporting of PTP Leader ID
- Reporting of Delay Request and Grandmaster destination IP address
- PTP message counters



Video Flows

- Primary and secondary Video flow Source and Destination Unicast or Multicast address and Port number
- Video Flow Enable/Disable
- Decap filtering on match of Source: IP Add or Port num; Destination: IP Add, Port num or MAC address and VLAN
- Packet counters and Sender Type



ST 2110 Decap Setup: Video

- Decap of Narrow, Narrow Linear or Wide sender types
- Manual control of all Video Parameters
- Video Format, Sampling Format, Bit Rate, Frame Rate and Sender Type
- Useful for non-NMOS, SDP systems



ST 2110 Audio Encap

- Primary and secondary Audio flow Source and Destination Unicast or Multicast address and Port number; RTP Payload Type
- Audio Flow Enable/Disable
- Selection of Audio Packet time: 1ms, 125µs, 250µs, 333µs, 500µs
- Tx Packet counters
- ST 2110-30 (PCM), -31 (AES3)



ST 2110 Audio Decap

- Primary and secondary Audio flow Source and Destination Unicast or Multicast address and Port number
- ST 2110-30/-31
- Decap filtering on match of Source: IP Add or Port num, Destination: IP Add, Port num or MAC address and VLAN
- Automatic detection of Audio Packet time: 1ms, 125µs, 250µs, 333µs, 500µs
- Manual control of the number of audio channels for non-NMOS, SDP systems



ST 2110 Audio Map

- Control of mapping of Audio channels between 2110 flows and SDI I/O
- Support for up to 16 channels of audio per flow
- 8 Encap audio flows
- 4 Decap audio flows



ST 2110 ANC Data

- ANC Data primary and secondary flow Source and Destination Unicast or Multicast address and Port number
- ANC Data Flow Enable/Disable
- Decap filtering on match of Source: IP Add or Port num, Destination: IP Add, Port num or MAC address and VLAN
- Packet Counters



IP-SDI and SDI-IP Gateway

- IP to SDI Gateway Enable/Disable – routes SDI I/O to IP SFP
- Encap or Decap gateway for 2110-20/30/40 and 2022-6
- Test pattern generator is automatically disabled when gateway is active



SFP Setup

- Configure SFP management address
- Encap video synchronizer and Audio PCM sample rate converter with offset control
- Synchronizes incoming SDI gateway or generated Video and Audio patterns to PTP
- Decap primary and secondary flow clean switch

Sx TAG Options and Accessories



3G-SDI including advanced formats [PHSXO-3GADV]

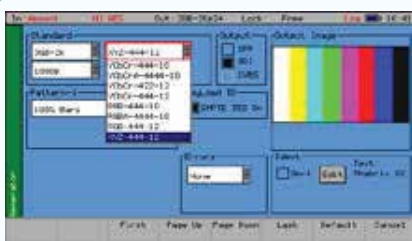

- 3G-SDI Level A and Level B
- Provides advanced formats including 4:2:2 YUV, 4:4:4 RGB and 4:4:4 YUV at 10/12 bit
- Analyze signals such as SMPTE 425-B carrying 1 x SMPTE 372M Dual-link payload

Audio break out cable [PHSXC-1]



- A break-out cable is available to provide AES input and output as well as calibrated balanced analog audio input and output to broadcast levels
- Connected to the TAG D-type connector, it includes both BNC and XLR connectors

MSA/non-MSA SFP+ Support [PHSXM-CAGEP]



- The Sx TAG supports a range of MSA and non-MSA SFPs providing interface support for Optical SDI, HDMI Inputs or Outputs, SDI transceiver and SMPTE ST 2110/2022-6 on 10Gbit/s multimode fiber
- Included as standard with Sx TAG
- Replacement cages are available

SFP: Electrical or Optical Transceivers



Electrical Transceiver [PHSFP-RT30-HDBNC]

- Allows closed loop testing in SDI environments
- BNC cable adapters provided with SFPs

Optical Transceiver [PHSFP-RT30-1310 or -1550]

- Single 1310/1550nm transmitter and receiver
- Allows closed loop testing of fibre installations

SFP: HDMI Output [PHSFP-HDMI-OUT]



- PHSFP-HDMI-OUT converts the TAG SDI output to HDMI without scaling artefacts
- The overall system provides SDI to HDMI Gateway conversion of 3G*/HD/SD-SDI signals with up to 8 channels of audio

HDMI EDID Viewer [PHSXO-EDID]

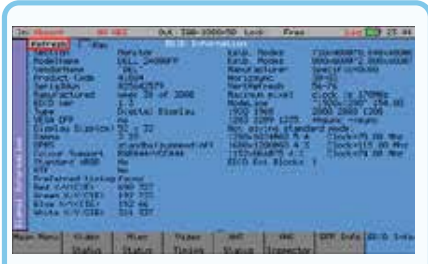

- Displays both RAW ancillary data and decoded EDID information
- Read back of the EDID information over HDMI via the PHSFP-HDMI-OUT SFP [purchased separately]
- Key applications include testing video walls in MCR installations, OB applications, professional AV infrastructure and manufacturing companies

SFP: IP ST 2110 & ST 2022-6 [PHSFP-10SR-IP]

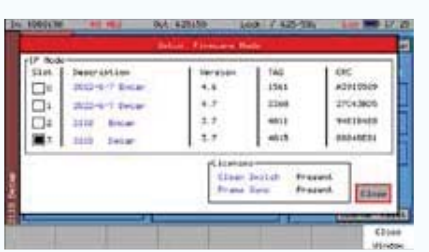

Sx TAG IP with Firmware Selection



Sx TAG IP with Decap (Rx)

- With the PHSFP-10SR-IP SFP+ 850nm multimode module and the PHSXO-IP software option, the Sx TAG can be used for generation, analysis and monitoring of SMPTE ST 2110-10/20/30/31/40 with NMOS IS-04/IS-05/IS-08 and ST 2022-6 IP formats
- The overall system also provides SDI to IP and IP to SDI Gateway conversion of 3G*/HD/SD-SDI signals with up to 16 channels of audio
- This functionality has been developed in conjunction with Embrixion
- Additional configuration windows are provided to configure and manage the IP flows

Optional Toolsets

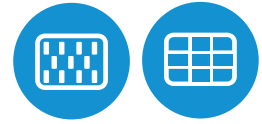

Adv. Video Formats [PHSXOF]

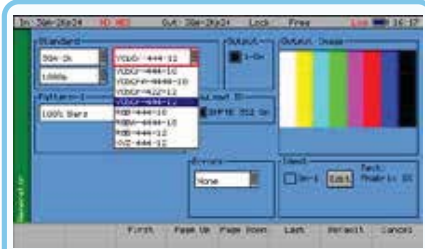

- 3G level A and B
- 4:2:2 YUV, 4:4:4 RGB and 4:4:4 YUV at 10/12 bit and XYZ at 12 bit
- 2048 x 1080 (2K) SMPTE ST 428-9 and digital cinema 2048-2:2011

AV Delay Generation

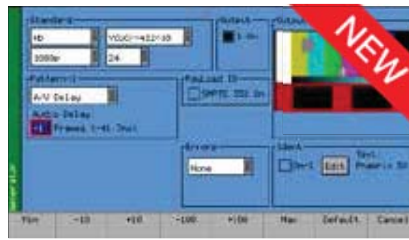

AV Delay Generator

- Adapted EBU Tech 3305 AV Sync and Operational Test Pattern to support SD and HD formats
- Compatible with third party AV delay analysers e.g.:LAWO V_pro8
- Enable AV Delay audio on up to 16 embedded channels and/or AES out

AV Delay Analysis [PHSXO-AVD]

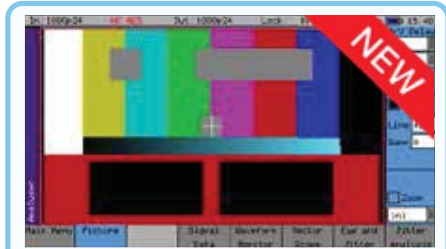

AV Delay Analyzer

- Measure the system propagation delay (latency) of either video/audio
- Support for adapted EBU Tech 3305 AV Sync and operation test pattern
- Support for LAWO V_line AV Sync test pattern
- Realtime update of measured AV delay
- +/- 400ms operating range
- Select audio from SDI or AES input

SDI Data Display & VANC/ANC Inspector [PHSXOSD]



- Two instruments that provide a detailed view of the data words contained within the SDI stream and ancillary data (VANC and ANC) packets
- This allows the analysis of complex faults and is particularly useful in determining compatibility issues between equipment and when debugging new product development in an R&D environment
- The ancillary packet analyzer also includes a DID or SDID search editor, freeze and freeze on trigger function
- A sophisticated range of user-definable trigger parameters is provided including: ANC, VANC or ANC+VANC, DID and SubDID values, line number range, Checksum, DBN, Parity and ANC Gap Errors
- Cursor link for locating chosen packet in data view/picture windows

Enhanced Remote Control [PHSXOR]

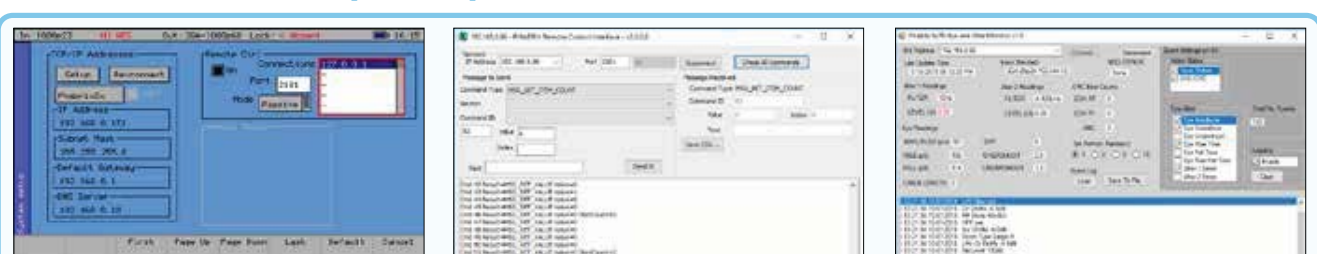

- This option allows complex applications to be created on a PC to perform test and measurement functions such as automated testing of routers and other broadcast equipment
- PHABRIX instruments act as a server and listen on a port waiting for incoming requests from clients such as a PC. All visual controls on the product have an associated command.

Optional Toolsets



Dolby Bitstream Generator and Analyzer [PHSXO-DAG]



- This toolset provides both Dolby Audio bitstream Generation and Analysis for Dolby E, Dolby Digital and Dolby Digital Plus. All Dolby related metadata parameters can be logged
- The Main Menu window provides a clear and easy to read status of the detected type of audio in each group with a snapshot of the Dolby program config and Dolby E guard band timing
- The generator contains a number of pre-configured test bitstreams. Engineers can then adjust both Dolby E, the metadata parameters, and the Dolby E line number to test broadcast infrastructure and downstream audio encoding equipment
- The analyzer displays the stream type, the metadata of a selected audio stream, the PA spacing and any CRC errors. For Dolby E the timing relationship in the SDI video stream guard band is displayed and the analyzer indicates if this the recommended line position for that format
- The detected Dolby Audio type is displayed in the audio meters, however the audio is not decoded, Dolby E metering is provided
- Logging triggers for errors relating to Dolby Audio include CRC errors, timing, and common and program metadata

Advanced Zone Plate Generator [PHSXOZ]

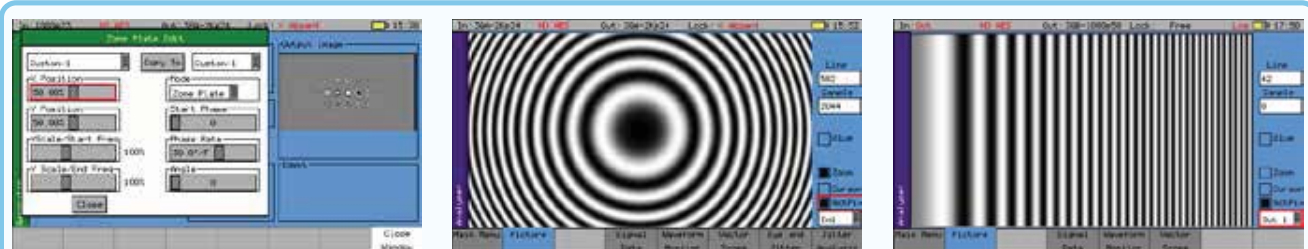

- Choice of Zone Plate, Grating or Sweep Patterns
- Sophisticated control set including: Start and End Frequency, Start Phase, Rate of change of Phase, Angle, and X and Y position
- Temporal control is particularly useful for testing up/down converters/monitors and applications which compress signals

Command Scripts with Print Report [PHSXOS]



- Allows an engineer to create a stack of commands for repeat testing of systems using the toolsets within the Sx series
- Tests can be configured and saved for recall by a user defined operator name. Command scripts can be created on the interface or created offline on a PC. The savings in time and the ability for an engineer to run a script to check equipment and return with a report is invaluable
- When 'run' reports are generated, they auto fill an on-board html file that can then be downloaded via the remote control facility and printed as a hard paper copy. The report also collects screen dumps of the instruments to accompany the report if required
- Additionally, users can add their own logo to personalize the reports

Sx TAG

Portable hybrid IP/SDI + Analog Generation, Analysis & Video/Audio Monitoring

Advanced Video Analysis Toolset

Sx TAG with its SFP, SDI and analog I/O offers incredible versatility in a handheld device. It is ideal for IP, 3G/HD/SD-SDI, optical SDI, HDMI and Analog test & measurement as well as AES eye analysis, for applications demanding true mobility and ease of use.

It provides support for SMPTE ST 2110-20/30/31/40 encapsulation/decapsulation with ST 2059 PTP, SDP and NMOS IS-04/IS-05/IS-08 as well as SMPTE ST 2022-6 encapsulation/decapsulation, using 10GE IP SFP+ modules developed by Embrionix.

Useful hybrid IP/SDI features include SDI to IP and IP to SDI gateways for both ST 2110-20/30/40 and ST 2022-6 as well as the ability to generate an analog reference output following the ST 2059 PTP or 2022-6 IP input.



Ordering

PHSXTAGC	TAG analyzer/generator/monitor SD/HD Handheld with PHABRIX soft carry case (includes SFP CAGE)
PHSXTAGC-IP	TAG analyzer/generator/monitor SD/HD + IP Handheld with PHABRIX soft carry case (includes SFP CAGE)

Software Options

PHSXO-3GADV	TAG 3G-SDI includes advanced formats and 2K support
PHSXOS	Command scripts + reports (repeat testing and create print report)
PHSXOSD	SDI Data display + VANC/ANC Inspector
PHSXOR	Enhanced Remote Control for integration
PHSXOZ	Advanced zone plate generator (Programmable Y zone plate)
PHSXO-DAG	Dolby E/D/D+ analysis + generation (streaming, metering, timing)
PHSXO-AVD	AV Delay Analysis
PHSXO-ENGT	Engineering bundle with six options, namely PHSXO-3GADV, PHSXOS, PHSXOSD, PHSXOR, PHSXOZ, PHSXO-DAG
PHSXO-EDID	HDMI EDID viewer software license (requires PHSFP-HDMI-OUT)
PHSXO-IP	IP Encap/Decap license (requires PHSFP-10SR-IP)

SFPs

PHSF-RT30-1310	SFP optical transceiver 3G*/HD/SD
PHSF-RT30-1550	SFP optical transceiver 3G*/HD/SD
PHSF-RT30-HDBNC	SFP electrical transceiver 3G*/HD/SD includes 2x HDBNC-BNC cables
PHSF-HDMI-OUT	HDMI V1.4/DVI 1.0 HDMI Output
PHSF-10SR-IP	10GBASE-SR ST 2022-6/2110 Encapsulator/Decapsulator

Accessories

PHSXM-CAGEP	Universal replacement SFP cage - MSA/Non-MSA with power down
PHSXC-1	D15 break out cable for AES, analog audio and GPI
PHSXWM	Sx wall mounting bracket for easy charging (does not include the charger)

Extended Warranty

PHSX-3YEAR	3 Year Warranty+
PHSX-5YEAR	5 Year Warranty +
Replacement battery service - pricing and availability on request	

+One year warranty included as standard

SxE

Portable 3G/HD/SD Generation, Analysis & Monitoring with Advanced Physical Layer Analysis

Real-Time Eye technology for SMPTE compliance issues

With advanced SDI physical layer analysis (Eye & Jitter), the SxE is ideal for applications such as video technology manufacturing and live production.

The instant, RTE™ (Real-Time Eye) technology speeds physical layer testing, and delivers automated measurements and logging for key parameters such as: rise time, fall time, delta, overshoot, undershoot and cable length. The Jitter analysis instrument enables an engineer to quickly analyze the nature of jitter present using a graph of jitter versus time.

Other key capabilities include Dolby® E, Dolby® Digital and Dolby® Digital Plus bitstream analysis, as well as video status logging, and remote operation over Ethernet. The SxE also now offers automatic link detection of single links of multi-link 3G and HD based UHD formats.



Ordering

PHSXE SxE SD/HD/3G Handheld unit for Eye and Jitter compliance with PHABRIX soft carry case

Software Options

- PHSXOS Command scripts + reports (repeat testing + create print report)
- PHSXOSD SDI Data display + VANC/ANC Inspector
- PHSXOR Enhanced remote control integration
- PHSXOZ Advanced zone plate generator (Programmable Y zone plate)
- PHSXOF Advanced video formats + 2K (422/444, YUV/RGB, 10/12 bit, SMPTE 428-9 D-Cinema/SMPTE ST 2048-2-2011)
- PHSXO-DAG Dolby E/D/D+ analysis + generation (streaming, metering, timing)
- PHSXO-AVD AV Delay Analysis
- PHSXO-ENG Engineering bundle with six options, namely PHSXOS, PHSXOSD, PHSXOR, PHSXOZ, PHSXOF, PHSXO-DAG

Accessories

PHSXWM Sx wall mounting bracket for easy charging (does not include the charger)

Extended Warranty

- PHSX-3YEAR 3 Year Warranty+
- PHSX-5YEAR 5 Year Warranty+

Replacement battery service - pricing and availability on request

+One year warranty included as standard

SxA

Portable 3G/HD/SD Generation, Analysis & Video/Audio Monitoring

Multi-channel audio analysis & monitoring

The SxA offers all of the same advanced signal generation, analysis and monitoring capabilities as the SxE, without the advanced Real-Time SDI physical layer analysis (eye and jitter instruments)

There's support for SMPTE compliance testing with over 350 different formats. An extensive array of video and audio tools includes a signal generator with moving test patterns, a high performance waveform, and ANC/VANC inspector. The SxA also offers 16 channel audio generation and metering with support for Dolby® E, Dolby® Digital and Dolby® Digital metadata and bitstream analysis. The SxA also now offers automatic link detection of single links of multi-link 3G and HD based UHD formats.



Ordering

PHSXAES SxA AES SD/HD/3G Handheld unit with PHABRIX soft carry case

Software Options

PHSXOS	Command Scripts and Reports (Repeat testing and create print report)
PHSXOSD	SDI Data Display + VANC/ANC Inspector
PHSXOR	Enhanced Remote Control integration
PHSXOZ	Advanced zone plate generator (Programmable Y zone plate)
PHSXOF	Advanced video formats + 2K (422/444, YUV/RGB, 10/12bit, SMPTE 428-9 D-Cinema/SMPTE ST 2048-2:2011)
PHSXO-DAG	Dolby E/D/D+ analysis + generation (streaming, metering, timing)
PHSXO-AVD	AV Delay Analysis
PHSXO-ENG	Engineering bundle with six options, namely PHSXOS, PHSXOSD, PHSXOR, PHSXOZ, PHSXOF, PHSXO-DAG

Accessories

PHSXWM Sx Wall mounting bracket for easy charging (does not include the charger)

Extended Warranty

PHSX-3YEAR	3 Year Warranty+
PHSX-5YEAR	5 Year Warranty+

Replacement battery service - pricing and availability on request

+One year warranty included as standard

SxD

Portable dual-link 3G/HD/SD-SDI Generation, Analysis & Video/Audio Monitoring

Dual SDI input/output analysis

The SxD is a dual-link 3G/HD/SD-SDI version of the SxA which is designed for video technology manufacturing and production applications. It has two SDI inputs, two SDI outputs and no AES input or outputs. It offers support of multiple advanced video standards up to a combined maximum data rate of 3Gbits across the two SDI links, including 422/444, YUV/RGB, 10/12 bit and SMPTE 428-9 D-Cinema/SMPTE ST 2048-2:2011 formats. The SxD also now offers automatic link detection of single links of multi-link 3G and HD based UHD formats.



Ordering

PHSXDL SxD Dual Link SD/HD/3G Handheld unit with PHABRIX soft carry case

Software Options

PHSXOS	Command Scripts and Reports (Repeat testing and create print report)
PHSXOSD	SDI Data Display + VANC/ANC Inspector
PHSXOR	Enhanced Remote Control integration
PHSXOZ	Advanced zone plate generator (Programmable Y zone plate)
PHSXO-DAG	Dolby E/D/D+ analysis + generation (streaming, metering, timing)
PHSXO-AVD	AV Delay Analysis
PHSXO-ENG	Engineering bundle with five options, namely PHSXOS, PHSXOSD, PHSXOR, PHSXOZ, PHSXO-DAG

Accessories

PHSXWM Sx Wall mounting bracket for easy charging (does not include the charger)

Extended Warranty

PHSX-3YEAR	3 Year Warranty+
PHSX-5YEAR	5 Year Warranty+

Replacement battery service - pricing and availability on request

+One year warranty included as standard

Specifications

Description	TAG	SxA	SxD	SxE
Analyzer/Generator/Monitor combined	●	●	●	●
Display 480 x 272 pixels auto-scaling 16:9 24-bit TFT 95 x 54mm display	●	●	●	●
3G-SDI, HD-SDI, SD-SDI as standard (3G-SDI available as an option on the TAG)	○	●	●	●
Video				
SDI Output 1 x 75 ohm BNC	N/A	●	●	●
SDI Input 1 x 75 ohm BNC	N/A	●	●	●
SDI Input/output selectable 1 x 75 ohm BNC	●	N/A	N/A	N/A
Composite analog in (PAL/NTSC) 1 x 75 ohm	●	N/A	N/A	N/A
Composite analog out (PAL/NTSC) 1 x 75 ohm BNC	●	N/A	N/A	N/A
Dual Link output 2 x 75 ohm BNC	N/A	N/A	●	N/A
Dual Link input 2 x 75 ohm BNC	N/A	N/A	●	N/A
Genlock Bi/Tri/SDI with cross lock	●	●	●	●
Reference Generator	●	N/A	N/A	N/A
Reference View	●	N/A	N/A	N/A
Text ident/Logo ident	●	●	●	●
EDH checking (SD-SDI) - CRC checking	●	●	●	●
Video Test Signals - 10 bits	●	●	●	●
Video Test Signals - 12 bits, RGB 4:4:4	○	○	●	○
Static test patterns 35 - Bouncing Box - Moving zone plate - A/V delay - User defined DPX, YUV, TGA, BMP	●	●	●	●
SMPTE formats supported	●	●	●	●
Video timing Offset line - pixel - range	●	●	●	●
Physical layer measurements				
Automated measurement - Eye amp, Rise/Fall time, Delta, Rise/Fall Overshoot	N/A	N/A	N/A	●
Jitter thermometers alignment, timing	N/A	N/A	N/A	●
Eye bit rates 3Gbps, 1.485Gbps, 270Mbps	N/A	N/A	N/A	●
Audio				
Generator/Monitor 48kHz 20-bit (SD-SDI) 24-bit (HD/3G-SDI)	●	●	●	●
Stereo balanced analog audio I/O (via 26-pin high-density D-type socket)	●	N/A	N/A	N/A
16 channel embedded audio	●	●	●	●
AES output 1 x 75 ohm BNC	N/A	●	N/A	●
AES input 1 x 75 ohm BNC	N/A	●	N/A	●
AES/GPI input/output (via 26-pin high-density D-type socket)	●	N/A	N/A	N/A
Test signal fixed tones 16	●	●	●	●
Test signal variable tones 1 Hz - 24 kHz in 1 Hz steps	●	●	●	●
Test signal white noise generation	●	●	●	●
Audio levels variable 0 to -100dB in 1dB steps	●	●	●	●
Audio phase invert	●	●	●	●
Dolby E/D/D plus present indication x 8 pairs	○	○	○	○
Internal speaker 0.5 watts	●	●	●	●
Audio DAC 24 bit stereo	●	●	●	●
Headphone socket 3.5mm	●	●	●	●
Logging				
Eye and Jitter & Export Log	N/A	N/A	N/A	●
SDI Signal & Export Log	●	●	●	●
AES & Export Log	●	●	N/A	●
SFP				
Optical/Copper/HDMI-OUT - Tx/Rx	○	N/A	N/A	N/A
IP SMPTE 2110 & 2022-6 Tx/Rx	○	N/A	N/A	N/A
General				
Internal Battery supply - Lithium Polymer	Up to 2 hours	Up to 2 hours	Up to 2 hours	Up to 2 hours
Internal storage 8Gb	●	●	●	●
Remote Control - web browser interface - Ethernet 10/100 BASE T	●	●	●	●
Battery Replacement Service Available	●	●	●	●
AC power supply included (universal) + Carry Case	●	●	●	●
1 year manufacturer's warranty - 3 & 5 year extended warranty options available	●	●	●	●
Size H:92mm, W:225mm, D:42mm, Weight 0.9 kg including integral battery	●	●	●	●

● Standard ○ Optional

Formats Supported (Generator/Analyzer)

SMPTE Stnds. Link (Content)	Interface	Resolution	Sampling Structure	Pixel Depth	Frame/Field Rate	SxA	SxD	SxE	TAG SDI	TAG 2022-6	TAG 2110
ST 259 (ST 125)	SD (625i)	720 x 576	4:2:2 (YCbCr)	10	50i	●	●	●	●	●	-
ST 259 (ST 125)	SD (525i)	720 x 485	4:2:2 (YCbCr)	10	59.94i	●	●	●	●	●	-
ST 292 (ST 296)	HD	1280 x 720	4:2:2 (YCbCr)	10	60p, 59.94p, 50p, 30p, 29.97p, 25p, 24p, 23.98p	●	●	●	●	●	●
ST 292 (ST 260)	HD	1920 x 1035	4:2:2 (YCbCr)	10	60i, 59.94i	●	●	●	●	-	-
ST 292 (ST 274)	HD	1920 x 1080	4:2:2 (YCbCr)	10	60i, 59.94i, 50i	●	●	●	●	●	●
ST 292 (ST 274)	HD	1920 x 1080	4:2:2 (YCbCr)	10	30p, 29.97p, 25p, 24p, 23.98p	●	●	●	●	●	●
ST 292 (RP 211)	HD	1920 x 1080	4:2:2 (YCbCr)	10	30PsF, 29.97PsF, 25PsF, 24PsF, 23.98PsF	●	●	●	●	●	*
ST 292 (ST 2048-2)	HD	2048 x 1080	4:2:2 (YCbCr)	10	30PsF, 29.97PsF, 25PsF, 24PsF, 23.98PsF, 30p, 29.97p, 25p, 24p, 23.98p	●	●	●	N/A	N/A	N/A
ST 372 (ST 274)	Dual Link HD	1920 x 1080	4:2:2 (YCbCr)	10	60p, 59.94p, 50p	N/A	●	N/A	N/A	N/A	N/A
ST 372 (ST 274)	Dual Link HD	1920 x 1080	4:4:4 (YCbCr/RGB) 4:4:4:4 (YCbCrA/RGBA)	10	60i, 59.94i, 50i, 30PsF, 29.97PsF, 25PsF, 24PsF, 23.98PsF, 30p, 29.97p, 25p, 24p, 23.98p	N/A	●	N/A	N/A	N/A	N/A
ST 372 (ST 274)	Dual Link HD	1920 x 1080	4:4:4 (YCbCr/RGB)	12	60i, 59.94i, 50i, 30PsF, 29.97PsF, 25PsF, 24PsF, 23.98PsF, 30p, 29.97p, 25p, 24p, 23.98p	N/A	●	N/A	N/A	N/A	N/A
ST 372 (ST 274)	Dual Link HD	1920 x 1080	4:2:2 (YCbCr) 4:2:2:4 (YCbCrA)	12	60i, 59.94i, 50i, 30PsF, 29.97PsF, 25PsF, 24PsF, 23.98PsF, 30p, 29.97p, 25p, 24p, 23.98p	N/A	●	N/A	N/A	N/A	N/A
ST 372 (ST 2048-2)	Dual Link HD	2048 x 1080	4:2:2 (YCbCr)	10	60p, 59.94p, 50p, 48p, 47.95p	N/A	●	N/A	N/A	N/A	N/A
ST 372 (ST 2048-2)	Dual Link HD	2048 x 1080	4:4:4 (YCbCr/RGB) 4:4:4:4 (YCbCrA/RGBA)	10	30PsF, 29.97PsF, 25PsF, 24PsF, 23.98PsF, 30p, 29.97p, 25p, 24p, 23.98p	N/A	●	N/A	N/A	N/A	N/A
ST 372 (ST 2048-2)	Dual Link HD	2048 x 1080	4:4:4 (YCbCr/RGB)	12	30PsF, 29.97PsF, 25PsF, 24PsF, 23.98PsF, 30p, 29.97p, 25p, 24p, 23.98p	N/A	●	N/A	N/A	N/A	N/A
ST 372 (ST 2048-2)	Dual Link HD	2048 x 1080	4:2:2 (YCbCr) 4:2:2:4 (YCbCrA)	12	30PsF, 29.97PsF, 25PsF, 24PsF, 23.98PsF, 30p, 29.97p, 25p, 24p, 23.98p	N/A	●	N/A	N/A	N/A	N/A
ST 372 (ST 428-9)	Dual Link HD	2048 x 1080	4:4:4 (XYZ)	12	24PsF 24p	N/A	●	N/A	N/A	N/A	N/A
ST 372 (ST 428-19)	Dual Link HD	2048 x 1080	4:4:4 (XYZ)	12	30PsF, 25PsF 30p, 25p	N/A	●	N/A	N/A	N/A	N/A
ST 425-1 (ST 274)	3G Level A (I)	1920 x 1080	4:2:2 (YCbCr)	10	60p, 59.94p, 50p	●	●	●	○	○	○
ST 425-1 (ST 2048-2)	3G Level A (I)	2048 x 1080	4:2:2 (YCbCr)	10	60p, 59.94p, 50p, 48p, 47.95p	○	●	○	○	**	○
ST 425-1 (ST 296)	3G Level A (2)	1280 x 720	4:4:4 (YCbCr/RGB) 4:4:4:4 (YCbCrA/RGBA)	10	60p, 59.94p, 50p, 30p, 29.97p, 25p, 24p, 23.98p	○	●	○	○	-	-
ST 425-1 (ST 274)	3G Level A (2)	1920 x 1080	4:4:4 (YCbCr/RGB) 4:4:4:4 (YCbCrA/RGBA)	10	60i, 59.94i, 50i, 30PsF, 29.97PsF, 25PsF, 24PsF, 23.98PsF, 30p, 29.97p, 25p, 24p, 23.98p	○	●	○	○	-	-
ST 425-1 (ST 2048-2)	3G Level A (2)	2048 x 1080	4:4:4 (YCbCr/RGB) 4:4:4:4 (YCbCrA/RGBA)	10	30PsF, 29.97PsF, 25PsF, 24PsF, 23.98PsF, 30p, 29.97p, 25p, 24p, 23.98p	○	●	○	○	-	-
ST 425-1 (ST 274)	3G Level A (3)	1920 x 1080	4:4:4 (YCbCr/RGB)	12	60i, 59.94i, 50i, 30p, 29.97p, 25p, 24p, 23.98p	○	●	○	○	-	-
ST 425-1 (ST 2048-2)	3G Level A (3)	2048 x 1080	4:4:4 (YCbCr/RGB)	12	30PsF, 29.97PsF, 25PsF, 24PsF, 23.98PsF, 30p, 29.97p, 25p, 24p, 23.98p	○	●	○	○	-	-
ST 425-1 (ST 428-9)	3G Level A (3)	2048 x 1080	4:4:4 (XYZ)	12	24PsF	○	●	○	○	-	-
ST 425-1 (ST 428-19)	3G Level A (3)	2048 x 1080	4:4:4 (XYZ)	12	30PsF, 25PsF	○	●	○	○	-	-
ST 425-1 (ST 274)	3G Level A (4)	1920 x 1080	4:2:2 (YCbCr)	12	60i, 59.94i, 50i, 30PsF, 29.97PsF, 25PsF, 24PsF, 23.98PsF, 30p, 29.97p, 25p, 24p, 23.98p	○	●	○	○	-	-
ST 425-1 (ST 2048-2)	3G Level A (4)	2048 x 1080	4:2:2 (YCbCr) 4:2:2:4 (YCbCrA)	12	30PsF, 29.97PsF, 25PsF, 24PsF, 23.98PsF, 30p, 29.97p, 25p, 24p, 23.98p	○	●	○	○	-	-
ST 425-1 (ST 274)	3G Level B-DL (I)	1920 x 1080	4:2:2 (YCbCr)	10	60p, 59.94p, 50p	●	●	●	○	-	N/A
ST 425-1 (ST 2048-2)	3G Level B-DL (I)	2048 x 1080	4:2:2 (YCbCr)	10	60p, 59.94p, 50p, 48p, 47.95p	○	●	○	○	-	N/A
ST 425-1 (ST 274)	3G Level B-DL (II)	1920 x 1080	4:4:4 (YCbCr/RGB) 4:4:4:4 (YCbCrA/RGBA)	10	60i, 59.94i, 50i, 30PsF, 29.97PsF, 25PsF, 24PsF, 23.98PsF, 30p, 29.97p, 25p, 24p, 23.98p	○	●	○	○	-	N/A
ST 425-1 (ST 2048-2)	3G Level B-DL (II)	2048 x 1080	4:4:4 (YCbCr/RGB) 4:4:4:4 (YCbCrA/RGBA)	10	30PsF, 29.97PsF, 25PsF, 24PsF, 23.98PsF, 30p, 29.97p, 25p, 24p, 23.98p	○	●	○	○	-	N/A
ST 425-1 (ST 274)	3G Level B-DL (III)	1920 x 1080	4:4:4 (YCbCr/RGB)	12	60i, 59.94i, 50i, 30p, 29.97p, 25p, 24p, 23.98p	○	●	○	○	-	N/A
ST 425-1 (ST 2048-2)	3G Level B-DL (III)	2048 x 1080	4:4:4 (YCbCr/RGB)	12	30PsF, 29.97PsF, 25PsF, 24PsF, 23.98PsF, 30p, 29.97p, 25p, 24p, 23.98p	○	●	○	○	-	N/A
ST 425-1 (ST 428-9)	3G Level B-DL (III)	2048 x 1080	4:4:4 (XYZ)	12	24PsF	○	●	○	○	-	N/A
ST 425-1 (ST 428-19)	3G Level B-DL (III)	2048 x 1080	4:4:4 (XYZ)	12	30PsF, 25PsF	○	●	○	○	-	N/A
ST 425-1 (ST 274)	3G Level B-DL (IV)	1920 x 1080	4:2:2 (YCbCr)	12	60i, 59.94i, 50i, 30PsF, 29.97PsF, 25PsF, 24PsF, 23.98PsF, 30p, 29.97p, 25p, 24p, 23.98p	○	●	○	○	-	N/A
ST 425-1 (ST 2048-2)	3G Level B-DL (IV)	2048 x 1080	4:2:2 (YCbCr) 4:2:2:4 (YCbCrA)	12	30PsF, 29.97PsF, 25PsF, 24PsF, 23.98PsF, 30p, 29.97p, 25p, 24p, 23.98p	○	●	○	○	-	N/A
ST 425-1 (ST 296)	3G Level B-DS	2x (1280 x 720)	4:2:2 (YCbCr)	10	60p, 59.94p, 50p, 30p, 29.97p, 25p, 24p, 23.98p	●	●	●	○	-	N/A
ST 425-1 (ST 274)	3G Level B-DS	2x (1920 x 1080)	4:2:2 (YCbCr)	10	60i, 59.94i, 50i, 30PsF, 29.97PsF, 25PsF, 24PsF, 23.98PsF, 30p, 29.97p, 25p, 24p, 23.98p	●	●	●	○	-	N/A
ST 425-1 (ST 2048-2)	3G Level B-DS	2x (2048 x 1080)	4:2:2 (YCbCr)	10	60i, 59.94i, 50i, 30PsF, 29.97PsF, 25PsF, 24PsF, 23.98PsF, 30p, 29.97p, 25p, 24p, 23.98p	●	●	●	○	-	N/A
Composite	CVBS		PAL-I, PAL-N		50i	N/A	N/A	N/A	●	N/A	N/A
Composite	CVBS		NTSC-M, NTSC-M(JP), PAL-M		59.94i	N/A	N/A	N/A	●	N/A	N/A

*Excluding 23.98, 24
**Excluding 48, 47.95

Additional Formats (Analyzer - Single Link Only)

The SxA, SxD and SxE handhelds now offer automatic link detection of single links of multi-link 3G and HD based UHD formats, as shown in the table below.

SMPTE Stnds. Link (Content)	Interface	Resolution	Sampling Structure	Pixel Depth	Frame/Field Rate	SxA	SxD	SxE	TAG SDI	TAG 2022-6	TAG 2110
ST 425-3 Annex B.1, (ST 2036-1)	Quad-link HD-SQ	3840 x 2160	4:2:2 (YCbCr)	10	30p, 29.97p, 25p, 24p, 23.98p	●	●	●	N/A	N/A	N/A
ST 425-3 Annex B.1, (ST 2048-1)	Quad-link HD-SQ	4096 x 2160	4:2:2 (YCbCr)	10	30p, 29.97p, 25p, 24p, 23.98p	○	●	○	N/A	N/A	N/A
ST 425-3 Annex B.2, (ST 2036-1)	Dual 3G-B-DS	3840 x 2160	4:2:2 (YCbCr)	10	30p, 29.97p, 25p, 24p, 23.98p	●	●	●	N/A	N/A	N/A
ST 425-3 Annex B.2, (ST 2048-1)	Dual 3G-B-DS	4096 x 2160	4:2:2 (YCbCr)	10	30p, 29.97p, 25p, 24p, 23.98p	○	●	○	N/A	N/A	N/A
ST 425-3 (ST 274)	Dual-link 3G-A,B (II)	1920 x 1080	4:4:4 (YCbCr/RGB) 4:4:4:4 (YCbCrA/RGBA)	10	60p, 59.94p, 50p	○	●	○	N/A	N/A	N/A
ST 425-3 (ST 2048-2)	Dual-link 3G-A,B (II)	2048 x 1080	4:4:4 (YCbCr/RGB) 4:4:4:4 (YCbCrA/RGBA)	10	60p, 59.94p, 50p, 48p, 47.95p	○	●	○	N/A	N/A	N/A
ST 425-3 (ST 274)	Dual-link 3G-A,B (III)	1920 x 1080	4:4:4 (YCbCr/RGB)	12	60p, 59.94p, 50p	○	●	○	N/A	N/A	N/A
ST 425-3 (ST 2048-2)	Dual-link 3G-A,B (III)	2048 x 1080	4:4:4 (YCbCr/RGB)	12	60p, 59.94p, 50p, 48p, 47.95p	○	●	○	N/A	N/A	N/A
ST 425-3 (ST 274)	Dual-link 3G-A,B (IV)	1920 x 1080	4:2:2 (YCbCr)	12	60p, 59.94p, 50p	○	●	○	N/A	N/A	N/A
ST 425-3 (ST 2048-2)	Dual-link 3G-A,B (IV)	2048 x 1080	4:2:2 (YCbCr) 4:2:2:4 (YCbCrA)	12	60p, 59.94p, 50p, 48p, 47.95p	○	●	○	N/A	N/A	N/A
ST 425-5 (ST 2036-1)	Quad-link 3G-A,B (I) 2SI	3840 x 2160	4:2:2 (YCbCr)	10	60p, 59.94p, 50p	●	●	●	N/A	N/A	N/A
ST 425-5 (ST 2048-1)	Quad-link 3G-A,B (I) 2SI	4096 x 2160	4:2:2 (YCbCr)	10	60p, 59.94p, 50p, 48p, 47.95p	○	●	○	N/A	N/A	N/A
ST 425-5 (ST 2036-1)	Quad-link 3G-A,B (2) 2SI	3840 x 2160	4:4:4 (YCbCr/RGB)	10	30p, 29.97p, 25p, 24p, 23.98p	○	●	○	N/A	N/A	N/A
ST 425-5 (ST 2048-1)	Quad-link 3G-A,B (2) 2SI	4096 x 2160	4:4:4 (YCbCr/RGB) 4:4:4:4 (YCbCrA/RGBA)	10	30p, 29.97p, 25p, 24p, 23.98p	○	●	○	N/A	N/A	N/A
ST 425-5 (ST 2036-1)	Quad-link 3G-A,B (3) 2SI	3840 x 2160	4:4:4 (YCbCr/RGB)	12	30p, 29.97p, 25p, 24p, 23.98p	○	●	○	N/A	N/A	N/A
ST 425-5 (ST 2048-1)	Quad-link 3G-A,B (3) 2SI	4096 x 2160	4:4:4 (YCbCr/RGB)	12	30p, 29.97p, 25p, 24p, 23.98p	○	●	○	N/A	N/A	N/A
ST 425-5 (ST 2036-1)	Quad-link 3G-A,B (4) 2SI	3840 x 2160	4:2:2 (YCbCr)	12	30p, 29.97p, 25p, 24p, 23.98p	○	●	○	N/A	N/A	N/A
ST 425-5 (ST 2048-1)	Quad-link 3G-A,B (4) 2SI	4096 x 2160	4:2:2 (YCbCr) 4:2:2:4 (YCbCrA)	12	30p, 29.97p, 25p, 24p, 23.98p	○	●	○	N/A	N/A	N/A
ST 425-5 Annex B, (ST 2036-1)	Quad-link 3G-A,B (I) SQ	3840 x 2160	4:2:2 (YCbCr)	10	60p, 59.94p, 50p	○	●	○	N/A	N/A	N/A
ST 425-5 Annex B, (ST 2048-1)	Quad-link 3G-A,B (I) SQ	4096 x 2160	4:2:2 (YCbCr)	10	60p, 59.94p, 50p, 48p, 47.95p	○	●	○	N/A	N/A	N/A
ST 425-5 Annex B, (ST 2036-1)	Quad-link 3G-A,B (2) SQ	3840 x 2160	4:4:4 (YCbCr/RGB)	10	30p, 29.97p, 25p, 24p, 23.98p	○	●	○	N/A	N/A	N/A
ST 425-5 Annex B, (ST 2048-1)	Quad-link 3G-A,B (2) SQ	4096 x 2160	4:4:4 (YCbCr/RGB) 4:4:4:4 (YCbCrA/RGBA)	10	30p, 29.97p, 25p, 24p, 23.98p	○	●	○	N/A	N/A	N/A
ST 425-5 Annex B, (ST 2036-1)	Quad-link 3G-A,B (3) SQ	3840 x 2160	4:4:4 (YCbCr/RGB)	12	30p, 29.97p, 25p, 24p, 23.98p	○	●	○	N/A	N/A	N/A
ST 425-5 Annex B, (ST 2048-1)	Quad-link 3G-A,B (3) SQ	4096 x 2160	4:4:4 (YCbCr/RGB)	12	30p, 29.97p, 25p, 24p, 23.98p	○	●	○	N/A	N/A	N/A
ST 425-5 Annex B, (ST 2036-1)	Quad-link 3G-A,B (4) SQ	3840 x 2160	4:2:2 (YCbCr)	12	30p, 29.97p, 25p, 24p, 23.98p	○	●	○	N/A	N/A	N/A
ST 425-5 Annex B, (ST 2048-1)	Quad-link 3G-A,B (4) SQ	4096 x 2160	4:2:2 (YCbCr) 4:2:2:4 (YCbCrA)	12	30p, 29.97p, 25p, 24p, 23.98p	○	●	○	N/A	N/A	N/A

● Standard (Single Link Only)
○ Optional (Single Link Only)

DISTRIBUTOR CONTACT:
CALTRON PTE LTD
email: caltron@caltron.sg
www.caltron.sg

Accessories & Dimensions

PHABRIX Soft Carry Case



Sx Wall Mounting Bracket [PHSXWM]



PHABRIX Sx Dimensions

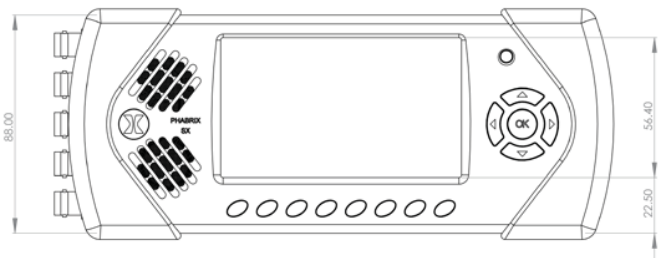

Sx Wall Mounting Bracket [PHSXWM] Dimensions

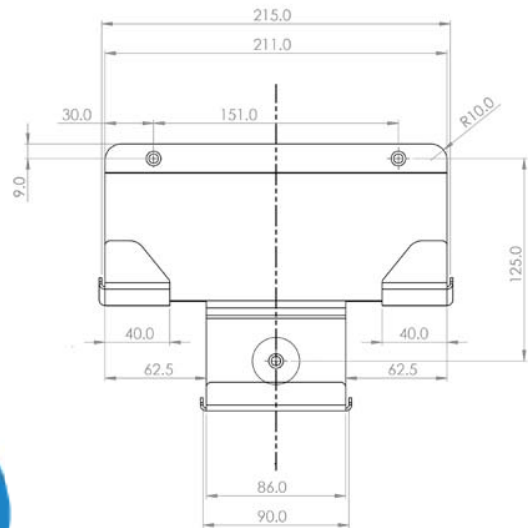

PHABRIX®

Leader

For more information about Sx Series of analyzers/generators, contact:

www.leaderphabrix.com

