

1. BS-2044FB Fluorescence Biological Microscope



BS-2044FB

Introduction

BS-2044FB microscope is a high quality fluorescence microscopes, which are specially designed for biological and medical research and teaching experiments for colleges, universities, laboratories and related institutes. With infinity color correction optical system and excellent Koehler illumination system, BS-2044FB can get uniform illumination, clear and bright images at any magnification. These microscopes can be used for teaching experiments, pathological examinations and clinical diagnosis. With outstanding functions, excellent cost performance, easy and comfortable operation, BS-2044FB fluorescence microscope presents over expected and splendid micro images.

Feature

1. Infinite Color Corrected Optical System provides sharp and comfortable images.
2. Wide-field high eye-point eyepieces and plan achromatic objectives make the effect of fluorescence observation more perfect.
3. Outstanding appearance design and ergonomics structure design, long time use without feeling tired.
4. With the design of security lock and safe limits, it is much more secure, stable and can be kept for long.
5. Various microscopic examinations can be fulfilled, such as brightfield, dark-field, phase contrast, fluorescence, simple polarizing and so on.
6. LED fluorescence excitation illumination, breaking through the traditional type, is more stable, low radiation and long working life. Special fluorescence filters for tuberculosis examination is available.

Application

BS-2044FB fluorescence microscope is ideal instruments for biological, pathological, histological, bacterial, immune, pharmacological and genetic fields. They can be widely used in education, medical and research.

Specification

Item	Specification	BS-2044FB	BS-2044FT	
Optical System	Infinite Color Corrected Optical System, parfocal distance 45mm	●	●	
Viewing Head	Seidentopf binocular head, 30° inclined, Interpupillary 50-75mm, 360° rotatable, eyepiece tube: Φ30mm	●	○	
	Seidentopf trinocular head, 30° inclined, Interpupillary 50-75mm, 360° rotatable, Fixed light splitting ratio: Eyepiece:Trinocular=8:2, eyepiece tube: Φ30mm	○	○	
	Seidentopf trinocular head(dedicated for fluorescence), 30° inclined, Interpupillary 50-75mm, 360° rotatable, Fixed light splitting ratio: Eyepiece:Trinocular=5:5, eyepiece tube: Φ30mm	○	●	
Eyepiece	High eyepoint wide field plan eyepiece PL 10×/22mm with adjustable diopter ±5	●	●	
	High eyepoint wide field plan eyepiece PL 10×/22mm with adjustable diopter ±5, with eyepiece micrometer	○	○	
	Eyepiece pointer	○	○	
	Eyepiece micrometer	○	○	
Objective	Infinite Plan Achromatic Objectives	4×, NA=0.10, WD=11.9mm	●	●
		10×, NA=0.25, WD=12.1mm	●	●
		20×, NA=0.45, WD=1.5mm	○	○
		40×(S), NA=0.65, WD=0.36mm	●	●
		60×(S), NA=0.85, WD=0.3mm	○	○
		100×(S, Oil), NA=1.25, WD=0.18mm	●	●
	Infinite Plan Phase Contrast Objective	10×, NA=0.25, WD=12.1mm	○	○
		20×, NA=0.45, WD=1.5mm	○	○
		40×(S), NA=0.65, WD=0.36mm	○	○
		100×(S, Oil), NA=1.25, WD=0.18mm	○	○
	Infinite Plan Semi-Apochromatic Fluorescence Objectives	4×, NA=0.13, WD=18.5mm	○	○
		10×, NA=0.30, WD=10.6mm	○	○
		20×, NA=0.50, WD=2.33mm	○	○
		40×(S), NA=0.75, WD=0.6mm	○	○
		100×(S, Oil), NA=1.28, WD=0.21mm	○	○
Nosepiece	Reversed Quadruple Nosepiece	●	●	
	Reversed Quintuple Nosepiece	○	○	
Stage	Double Layers Mechanical Stage 150mm×140mm, moving range 76mm×50mm, double slide holder, accuracy: 0.1mm	●	●	
	Rackless Double Layers Mechanical Stage 150mm×162mm, moving range 76mm×50mm, double slide holder, accuracy: 0.1mm, Wear-resistant and anti-corrosion treatment on the stage surface	○	○	
Condenser	N.A.1.25 Koehler illumination condenser (with plug-in phase contrast and dark field plate slot), condenser preset center and height adjustable	●	●	
Focusing	Low position coaxial focusing system, moving range 30mm, with upper limit and tightness adjustment, fine division 0.002mm	●	●	
Transmitted	Adaptive 100V-240V, AC50/60Hz wide range voltage, single high brightness 3W	●	●	

Illumination	LED (preset center), light intensity can be continuously adjusted		
Mercury Reflected Illumination	Mercury reflected fluorescence illuminator, 100W mercury lamp house, 100W DC mercury bulb (OSRAM/ Chinese brand)	●	●
LED Fluorescence Reflected Illumination	B1 band-pass type fluorescence module, with intensity adjusting knob, and switch knob for bright field and fluorescence, central wavelength:470nm	○	○
	G1 band-pass type LED fluorescence module, with intensity adjusting knob, and switch knob for bright field and fluorescence, central wavelength: 560nm	○	○
	B4 LED fluorescence module dedicated for TB, with intensity adjusting knob, and switch knob for bright field and fluorescence, central wavelength: 455nm	○	○
	UV2 ultraviolet long-pass type LED module, with intensity adjusting knob, and switch knob for bright field and fluorescence, central wavelength: 365nm	○	○
	Other various LED module for option, which can be custom-tailor according to the needs of clinical diagnosis.	○	○
Filters	Blue filter Φ45mm	○	○
	Green filter Φ45mm	○	○
	Yellow filter Φ45mm	○	○
	Neutral filter Φ45mm	○	○
Polarizing Kit	Polarizer	○	○
	Analyzer	○	○
Dark Field Plate	Dark field insert plate (used for 4x-40x objectives)	○	○
Centering Telescope	Centering TelescopeΦ23.2mm (used with phase contrast plate and objective)	○	○
Phase Contact Plate	10x, 40x Phase Contact Insert Plate (used for 10x, 40x phase contrast objectives)	○	○
	20x, 100x Phase Contact Insert Plate (used for 20x, 100x phase contrast objectives)	○	○
C-mount Adapter	0.35x C-mount adapter, adjustable	○	○
	0.5x C-mount adapter, adjustable	○	○
	1x C-mount adapter, adjustable	○	○
	Trinocular tube for digital eyepiece (Φ23.2mm)	○	○
Packing	2 cartons/set, 58x56x28cm, GW: 10kgs, NW: 8kgs; 51x31x49cm, GW: 11kgs, NW: 9kgs	●	●

Note: ● Standard Outfit, ○ Optional

Sample Images

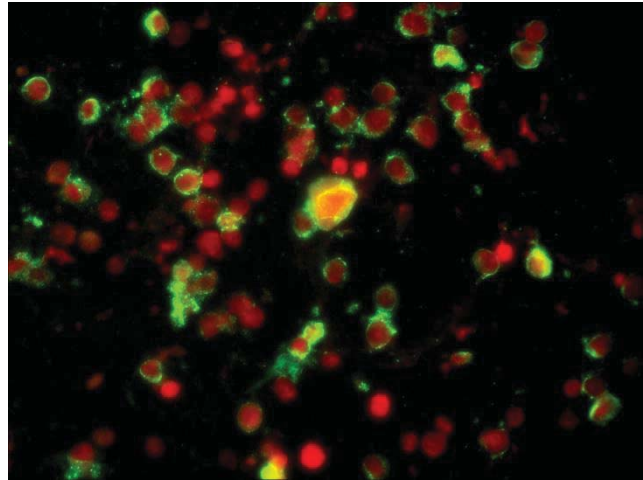
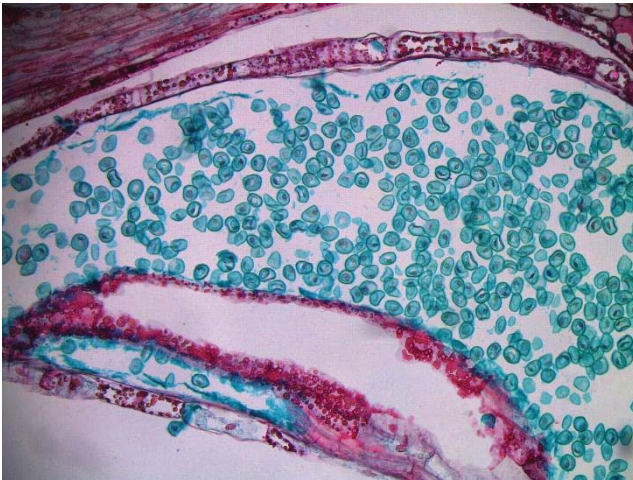

Dimension

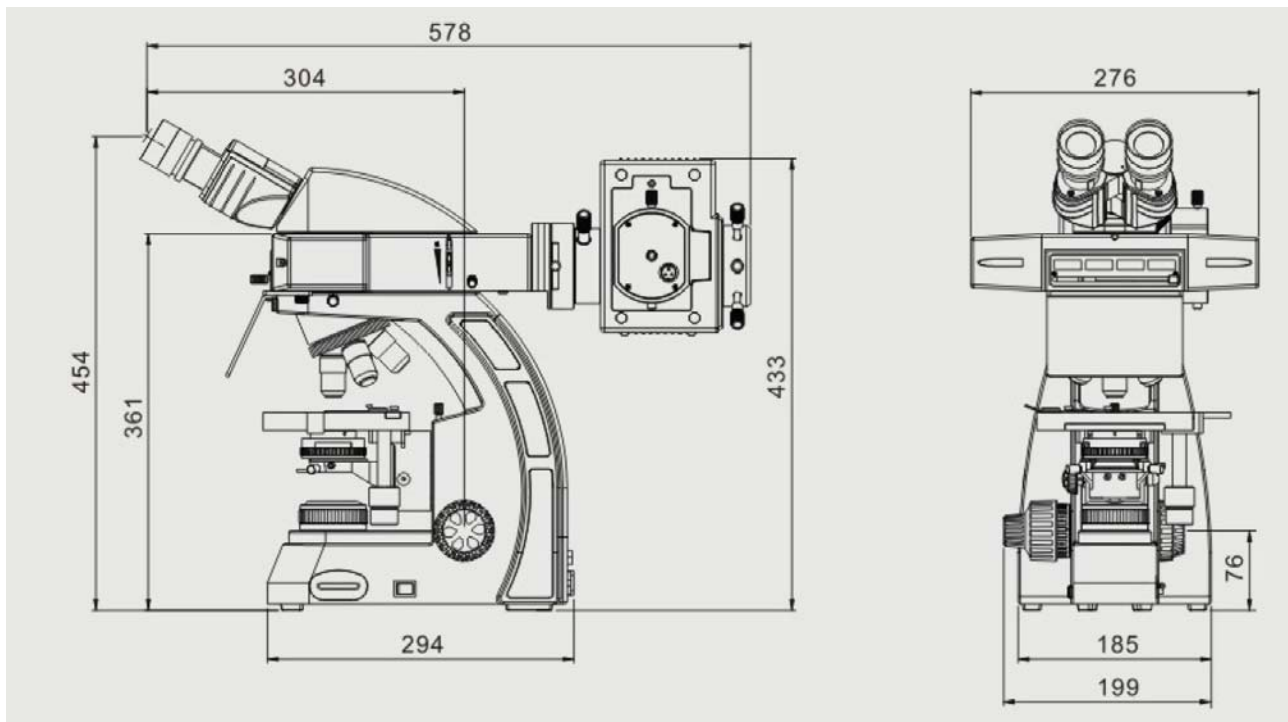

Unit:mm

2. BS-2044F(LED) LED Fluorescence Biological Microscope



BS-2044FB(LED)



BS-2044FT(LED)

Introduction

BS-2044FB(LED) LED fluorescence microscope is a high quality microscope that is specially designed for biological, medical research and teaching for colleges, universities and laboratories.

With infinity color correction optical system and excellent Koehler illumination system, BS-2044FB(LED) microscope can get uniform illumination, clear and bright images at any magnification. These microscopes can be used for clinical and pathological examinations. With outstanding functions, excellent cost performance and ease-of-use operations, BS-2044FB(LED) microscope presents over excellent micro images.

BS-2044F(LED) with B4 LED fluorescence module can be used for diagnosis of tuberculosis (TB)

Feature

1. Infinite Color Corrected Optical System provides sharp and comfortable images.
2. Wide-field high eye-point eyepieces and plan achromatic objectives and semi-APO fluorescence objectives make the effect of fluorescence observation more perfect.
3. Outstanding appearance design and ergonomics structure design, long time use without feeling tired.
4. With the design of security lock and safe limits, it is much more secure, stable and can be kept for long.
5. Various microscopic examinations can be fulfilled, such as brightfield, dark-field, phase contrast, fluorescence, simple polarizing and so on.
6. LED fluorescence excitation illumination, breaking through the traditional type, is more stable, low radiation and long working life. Special fluorescence filter(B4) for tuberculosis examination is available. Except for TB test module B4, you could select B1, G1, UV2 fluorescence modules according to different applications. You can also choose several modules and replace them when you need.

B1: EGFP/GFP/FITC /Alexa Fluor@488
Cy2@/DIO/Fluo-4

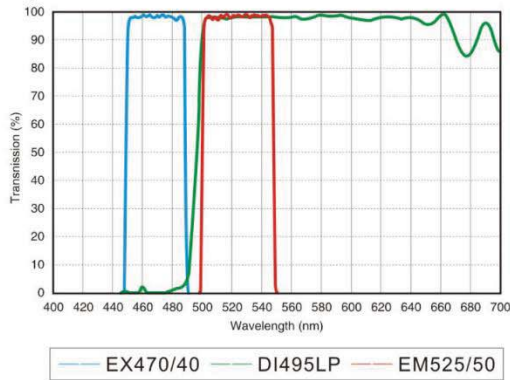

G1: TexasRED@/TexasRed@-X/Cy3.5
Mito Tracker@Red

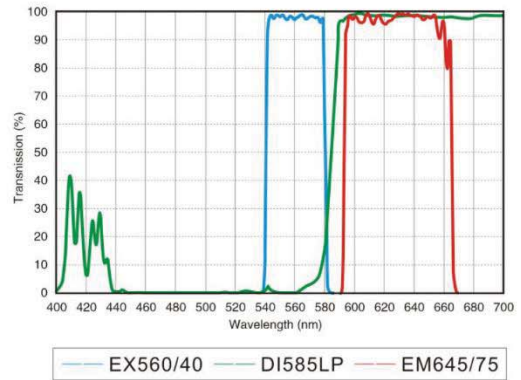

B2: EGFP/GFP/FITC /Alexa Fluor@488
Cy2@/DIO/Fluo-4

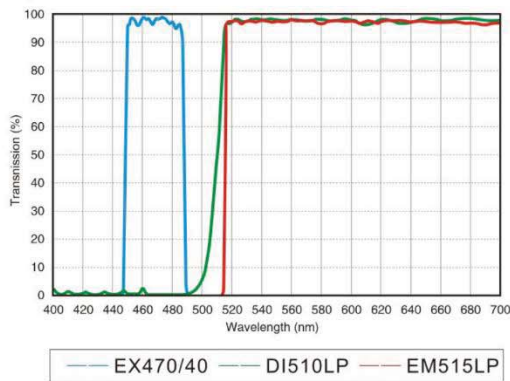

B4: Auramine O/wtGFP

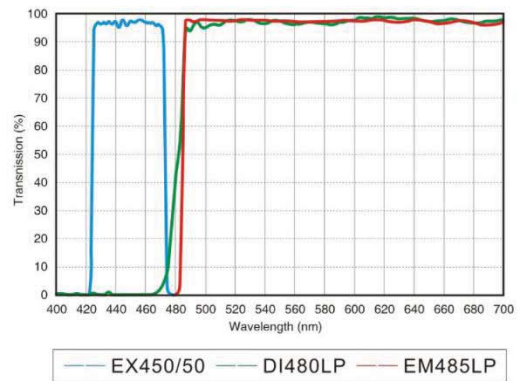

UV1: DAPI/Hoechst 33342/33258 AMCA/
AMCA-X Blue/ Alexa Fluor® 350

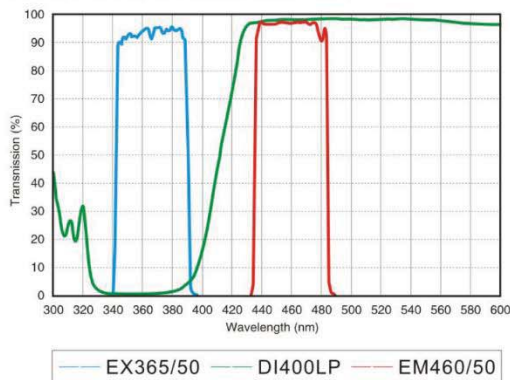

UV2: DAPI/Hoechst 33342/33258 AMCA/
AMCA-X Blue/ Alexa Fluor® 350

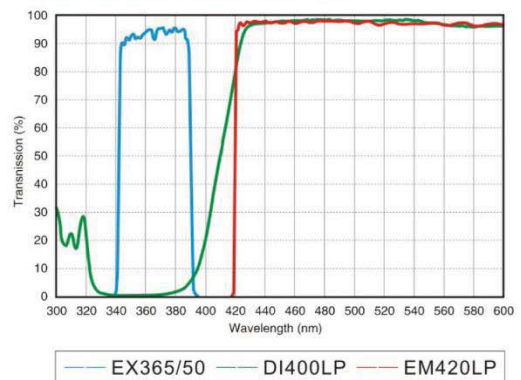

7. The Single-band LED fluorescence attachment have light intensity control function, with 6V/2A DC power supply, external transformer, easy connection and safe use. There is a switch and easy to change from fluorescence observation to bright field observation with transmitted illumination.



8. Semi-APO fluorescence objectives are optional. These objectives have large numerical aperture, provide high-resolution, high contrast microscopic images. We also can provide objectives without cover slip corrections, which is used to observe smear slides.



Infinite Plan Semi-APO fluorescence objectives without cover slip corrections



Infinite Plan Semi-APO fluorescence objectives with 0.17mm cover slip corrections

Application

BS-2044FB(LED) fluorescence microscope is ideal instrument for biological, pathological, histological, bacterial,

immune, pharmacological and genetic fields. They can be widely used in education, medical and sanitary establishments, such as schools, hospitals, clinics, laboratories, medical academies, colleges, universities and related teaching labs and research centers.

Specification

Item	Specification	BS-2044FB (LED)	BS-2044FT (LED)	
Optical System	Infinite Color Corrected Optical System, parfocal distance 45mm	●	●	
Viewing Head	Seidentopf binocular head, 30° inclined, Interpupillary 50-75mm, 360° rotatable, eyepiece tube: Φ30mm	●	○	
	Seidentopf trinocular head, 30° inclined, Interpupillary 50-75mm, 360° rotatable, Fixed light splitting ratio: Eyepiece:Trinocular=8:2, eyepiece tube: Φ30mm	○	○	
	Seidentopf trinocular head(dedicated for fluorescence), 30° inclined, Interpupillary 50-75mm, 360° rotatable, Fixed light splitting ratio: Eyepiece:Trinocular=5:5, eyepiece tube: Φ30mm	○	●	
Eyepiece	High eyepoint wide field plan eyepiece PL 10×/22mm with adjustable diopter ±5	●	●	
	High eyepoint wide field plan eyepiece PL 10×/22mm with adjustable diopter ±5, with eyepiece micrometer	○	○	
	Eyepiece pointer	○	○	
	Eyepiece micrometer	○	○	
Objective	Infinite Plan Achromatic Objectives	4×, NA=0.10, WD=11.9mm	●	●
		10×, NA=0.25, WD=12.1mm	●	●
		20×, NA=0.45, WD=1.5mm	○	○
		40×(S), NA=0.65, WD=0.36mm	●	●
		60×(S), NA=0.85, WD=0.3mm	○	○
		100×(S, Oil), NA=1.25, WD=0.18mm	●	●
	Infinite Plan Phase Contrast Objective	10×, NA=0.25, WD=12.1mm	○	○
		20×, NA=0.45, WD=1.5mm	○	○
		40×(S), NA=0.65, WD=0.36mm	○	○
		100×(S, Oil), NA=1.25, WD=0.18mm	○	○
	Infinite Plan Semi-Apochromatic Fluorescence Objectives	4×, NA=0.13, WD=18.5mm	○	○
		10×, NA=0.30, WD=10.6mm	○	○
		20×, NA=0.50, WD=2.33mm	○	○
		40×(S), NA=0.75, WD=0.6mm	○	○
100×(S, Oil), NA=1.28, WD=0.21mm		○	○	
Nosepiece	Reversed Quadruple Nosepiece	●	●	
	Reversed Quintuple Nosepiece	○	○	
Stage	Double Layers Mechanical Stage 150mm×140mm, moving range 76mm×50mm, double slide holder, accuracy: 0.1mm	●	●	
	Rackless Double Layers Mechanical Stage 150mm×162mm, moving range	○	○	

	76mm×50mm, double slide holder, accuracy: 0.1mm, Wear-resistant and anti-corrosion treatment on the stage surface		
Condenser	N.A.1.25 Koehler illumination condenser (with plug-in phase contrast and dark field plate slot), condenser preset center and height adjustable	●	●
Focusing	Low position coaxial focusing system, moving range 30mm, with upper limit and tightness adjustment, fine division 0.002mm	●	●
Transmitted Illumination	Adaptive 100V-240V, AC50/60Hz wide range voltage, single high brightness 3W LED (preset center), light intensity can be continuously adjusted	●	●
Mercury Reflected Illumination	Mercury reflected fluorescence illuminator, 100W mercury lamp house, 100W DC mercury bulb (OSRAM/ Chinese brand), with B1, G1 fluorescence filters	○	○
LED Fluorescence Reflected Illumination	B1 band-pass type fluorescence module, with intensity adjusting knob, and switch knob for bright field and fluorescence, central wavelength:470nm	●	●
	G1 band-pass type LED fluorescence module, with intensity adjusting knob, and switch knob for bright field and fluorescence, central wavelength: 560nm	○	○
	B4 LED fluorescence module dedicated for TB, with intensity adjusting knob, and switch knob for bright field and fluorescence, central wavelength: 455nm	○	○
	UV2 ultraviolet long-pass type LED module, with intensity adjusting knob, and switch knob for bright field and fluorescence, central wavelength: 365nm	○	○
	Other various LED module for option, which can be custom-tailor according to the needs of clinical diagnosis.	○	○
Filters	Blue filter Φ45mm	○	○
	Green filter Φ45mm	○	○
	Yellow filter Φ45mm	○	○
	Neutral filter Φ45mm	○	○
Polarizing Kit	Polarizer	○	○
	Analyzer	○	○
Dark Field Plate	Dark field insert plate (used for 4×-40× objectives)	○	○
Centering Telescope	Centering TelescopeΦ23.2mm (used with phase contrast plate and objective)	○	○
Phase Contact Plate	10×, 40× Phase Contact Insert Plate (used for 10×, 40× phase contrast objectives)	○	○
	20×, 100× Phase Contact Insert Plate (used for 20×, 100× phase contrast objectives)	○	○
C-mount Adapter	0.35× C-mount adapter, adjustable	○	○
	0.5× C-mount adapter, adjustable	○	○
	1× C-mount adapter, adjustable	○	○
	Trinocular tube for digital eyepiece (Φ23.2mm)	○	○
Packing	2 cartons/set, 58x56x28cm, GW: 10kgs, NW: 8kgs; 51x31x49cm, GW: 11kgs, NW: 9kgs	●	●

Note: ● Standard Outfit, ○ Optional

Sample Images

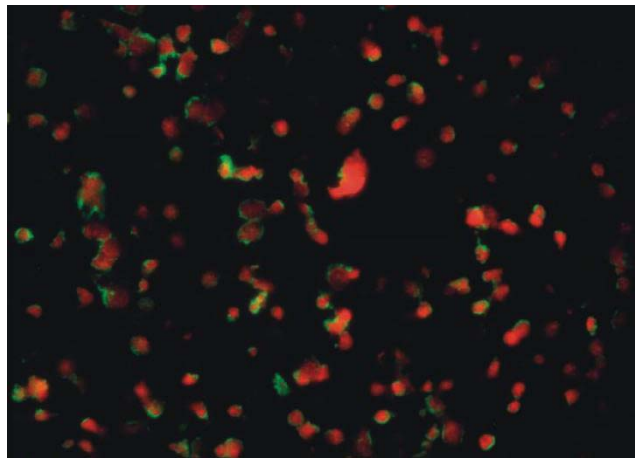
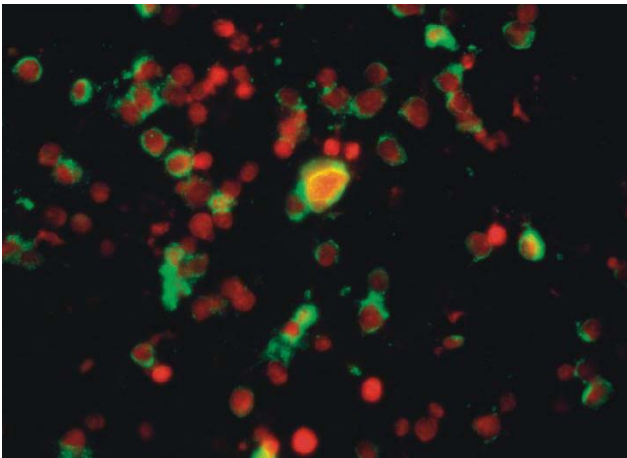
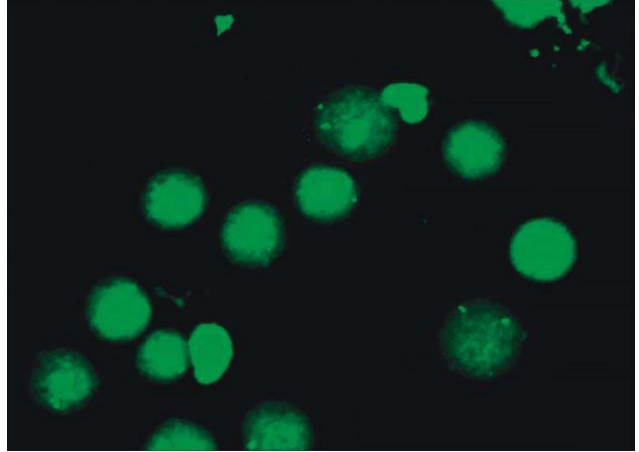
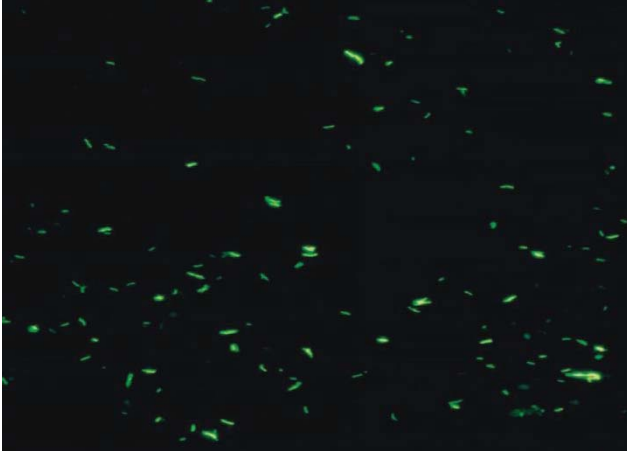

Dimension

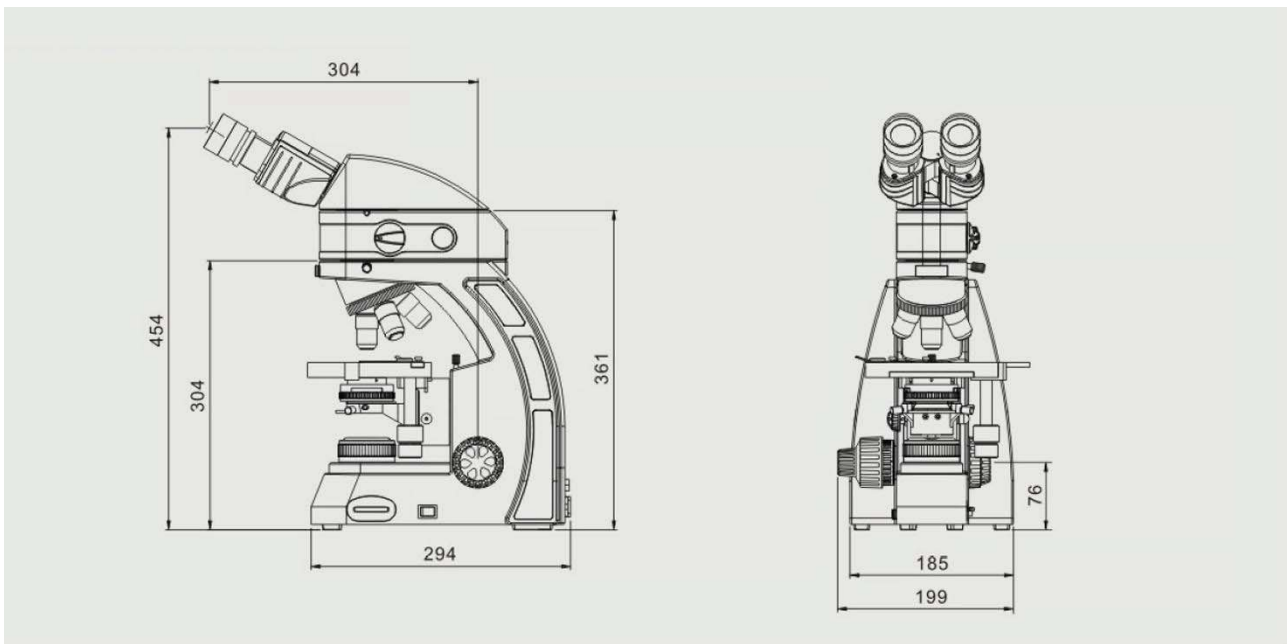

Unit:mm