

QxL

USER MANUAL

Software Release 6.1



Preface

About this Manual

This User Manual is a guide to the functions provided by your Qx Series instrument. For further information on PHABRIX products, please refer to the PHABRIX web page: <https://www.phabrix.com/products>

Notice

The information in this document has been produced by PHABRIX Ltd with care and is believed to be accurate. PHABRIX Ltd does not assume responsibility for loss or damage resulting from errors, omissions or inaccuracies herein. This document is subject to change, and revisions may be made and issued to include such changes.

No part of this document may be reproduced, stored in a retrieval system, or transmitted in any form or by any means, electronic, mechanical, recorded or otherwise without the prior written consent of PHABRIX Ltd.

Copyright © PHABRIX Ltd. All rights reserved. Software products licensed are owned by PHABRIX Ltd and are protected by international treaty provisions and national copyright laws.

PHABRIX® Limited

Omega House
Enterprise Way,
Thatcham, Berkshire
RG19 4AE

United Kingdom

Phone: + 44 (0)1635 873030

Email: support@phabrix.com

Web: <https://www.phabrix.com>

Trademarks

Dolby and the double-D symbol are registered trademarks of Dolby Laboratories Licensing Corporation. The following are trademarks of Dolby Laboratories Licensing Corporation:

- Dolby®
- Dolby Atmos®
- Dolby Digital®
- Dolby Digital Plus™
- Dolby E™
- Dolby ED2™

HDMI® is the registered trademark of HDMI Licensing and is used within the document for identification purposes only.

RealVNC® and VNC® are registered trademarks of RealVNC Ltd.

PHABRIX® is the registered trademark of PHABRIX Limited, A Leader Company.

RTE™ (Real-Time Eye) is a trademark of PHABRIX Limited, A Leader Company.

Acknowledgments

The Dolby Decoder available with the QxL is manufactured under license from Dolby Laboratories Licensing Corporation.

Revision

This manual is a revision-controlled document. Any changes to any page content will be reflected in the overall revision status of the whole manual.

Release	Date	Software Version	Updates Include:
14a	July 2024	6.1	ST 2022-7 Seamless IP Protection Switching (SIPS) for ST 2022-6 flows.
13a	May 2024	6.0	Combined boot allowing you to switch seamlessly between IP and optional SDI inputs / outputs without rebooting the unit.
12a	December 2023	5.4	Support for full-range and bug fixes.
11a	October 2023	5.3	Improved support of SD-SDI source input video on SDI IN A, including enhancements to the aspect ratio scaler in the Analyzer - Picture instrument. In addition SMPTE ST 352 payload identifiers are no longer displayed in the Analyzer - Video Standard when the user selects to ignore or manually override the ST 352 identifiers.
10a	August 2023	5.2	Support for analysis of SD-SDI source input video on SDI IN A. Recording of NMOS logs in Event Logging instrument.
9a	May 2023	5.1	User interface changes, color-coded icons, improvements to instruments: Generator, Analyzer - 2110 Format Setup, Analyzer - Video Standard
8a	November 2022	4.8	Advanced waveforms; new window slider control in NMOS SDP Rx/Tx displays.
7a	July 2022	4.7	Support for: browser remote access using noVNC; Rx of up to four 2110-30/31 audio flows; generation of EUHD Formats in 2110 mode, selection of 2022-6 Flows in 2110 mode, exFAT formatted USB sticks.
6a	March 2022	4.6	Support for Dolby® E audio by optional Dolby Decoder in Analyzer - Audio Meters instrument and separate Analyzer - Dolby Metadata instrument. Dolby Metadata instrument.
5a	March 2022	4.5	Enhanced NMOS configuration with NMOS Receiver (SDP and IS05) and NMOS Sender (SDP and IS05). Optional PCAP Packet capture for IP analysis. Optional support for YCbCr/RGB 444 8/10/12 bit, 48 - 60 Hz extended UHD formats. Selectable ATC-LTC or ATC-VITC. Generate 10-bit and 12-bit PsF formats in 2110 boot mode.
4b	September 2021	4.3.1	Support for detection of Dolby ED2 and bug fixes.
4a	May 2021	4.3	Support of additional SDI and IP standards; advanced ST 2110-40 IP signal generation by way of Timecode Generator; automatic video format detection and comparison of SDP and manual override parameters.
3b	February 2021	4.2.2	Display Forward Error Correction (FEC) status and link speed in SFP E/F - Network Stats instrument and provide control to enable / disable FEC.
3a	January 2021	4.2	Inclusion of IP Transmit Instrument for SMPTE 2110
2a	November 2020	4.1	Inclusion of Loudness Instrument
1	August 2020	4.0	First release of QxL User Manual

General Safety Information

General Safety



Avoiding Personal Injury

Warning: This instrument is designed for use by qualified personnel only.

No internal user-serviceable parts are provided. Units should be returned to your local PHABRIX agent for servicing.

The Operator must NOT remove the case from the unit as this will invalidate the warranty.

Do not spill any liquid onto the unit or its power adapter.

Warning: Do not look directly into the fiber optic connections of cable as this may cause permanent damage to the eyes.

Power Supply

Make sure that the unit is connected to the correct power supply voltage. A power supply adapter is supplied with the unit which may be connected to any AC power supply between 100 and 240 VAC at 50-60 Hz. Only the supplied power adapter should be used with the unit. Do not use a damaged AC cable with the unit as it may cause a shock or fire hazard. Replacement AC cables are available from your local PHABRIX agent.

This unit may have two power supply cords connected. Make sure to disconnect all power supply cords before servicing to avoid electric shock.

Mains AC powered devices are shipped with a three wire electrical cord with a grounding-type plug designed to fit only a grounding-type power outlet. Do not circumvent this safety feature. Equipment grounding must comply with local and national electrical standards.

Internal Battery

The unit includes a 3 V Lithium battery (type CR1225) to maintain the system clock and ensure memory persistence in the event of mains power loss. Return the unit to PHABRIX in the event that the battery needs replacing.

External Battery Pack

The unit has the facility to mount an external battery on either a factory-fitted V-mount or Anton/Bauer® Gold Mount® (G-mount), camera battery mount.

Any user-supplied battery pack must be capable of providing between 11 and 17 V DC at a minimum current of 9 A.

Note: When using an external battery pack with the unit, it is not possible to charge the battery from the unit, an external charger is required.

Note: To prevent unnecessary battery discharge, the External Battery Pack must be removed or disconnected from the unit when the unit is powered off.

Installation Environment

Operating Temperature



Warning: The unit should only be operated between 0 and 40° Celsius (32 and 104° Fahrenheit), non-condensing. If the unit is operated at a higher temperature, there is a possibility of a fire hazard. If the temperature is changed rapidly from a cold environment to a hot environment, moisture can be created internally which can cause malfunction or damage the unit. Allow the unit to sit for 30 minutes without power applied to reduce any possibility of condensation. If the internal component temperature rises above 85° Celsius (185° Fahrenheit) the unit will switch OFF automatically.

Input / Output Terminals



Do not connect the input or output BNC connectors to external power as this can damage the internal circuitry and cause the unit to work incorrectly.

The BNC connectors fitted on this unit are 75 ohm type which are not compatible with 50 ohm plugs.

Warning: The use of 50 ohm plugs will permanently damage the connectors on the unit. The use of 50 ohm plugs is considered to be misuse of the equipment and will therefore invalidate the unit's warranty.

When Not In Use

Disconnect the unit from the power supply and AC power source when not in use.

Maintenance



Wipe the case gently with a soft, lint-free cloth, lightly dampened with a neutral cleaning agent. A screen cleaning cloth may be used to clean the LCD. Do not apply force to the LCD when cleaning or it may be damaged.

Warning: Remove the power supply from the unit and switch OFF before cleaning. Do not allow any water or other liquid to enter the unit while cleaning.

RoHS 2 Compliance

PHABRIX products are designed and manufactured using only Restriction of Hazardous Substances (RoHS) compliant components and materials. Based on information provided by our suppliers, therefore, PHABRIX certifies that ALL products that it manufactures are RoHS-5 compliant and that they do not exceed the designated levels of lead, cadmium, mercury, hexavalent chromium,

polybrominated biphenyl (PBB) and polybrominated diphenyl ether flame retardants (PBDE) legislated under the provisions of the “*European Parliament and Council Directive*” on the “*Restriction of the Use of Certain Hazardous Substances in Electrical and Electronic Equipment (2011/65/EC)*” and associated regulations collectively known as the RoHS Regulations.

Disposal of Equipment



This product is subject to the European WEEE (Waste Electrical and Electronic Equipment) directive and should be disposed of according to the regulations of each country.

Table of Contents

Preface	ii
About this Manual	ii
Notice	ii
Trademarks	iii
Acknowledgments	iii
Revision	iv
General Safety Information	v
General Safety	v
Avoiding Personal Injury	v
Power Supply	v
Internal Battery	v
External Battery Pack	v
Installation Environment	vi
Operating Temperature	vi
Input / Output Terminals	vi
When Not In Use	vi
Maintenance	vi
RoHS 2 Compliance	vi
Disposal of Equipment	vii
1	1-1
Getting Started	1-1
Getting Started Quick Reference	1-2
What's in the Box?	1-2
Mounting the Unit	1-2
Desktop Mounting	1-2
Rack Mounting	1-2
Overview of the QxL Rear Panel Connectors	1-4
Connecting Essential Cables to the Unit	1-7
Powering up the QxL	1-9
IP and SDI Connections to the Unit	1-10
Standard IP-Only Configuration	1-10
Optional SDI Configuration	1-10
Powering-down the Unit	1-12
2	2-1
Working with the User Interface	2-1
Overview of the Product Structure and Options	2-2
Introduction	2-2
Toolsets and Instruments	2-2
Standard QxL Toolsets	2-3
Standard Toolset	2-3
Standard IP Monitoring Toolset for ST 2110 and ST 2022-6 IP Inputs	2-4
Additional IP Toolsets	2-5
IP Network Traffic Toolset for Standards ST 2110 and ST 2022-6	2-5
IP Packet Capture (PCAP) Toolset for ST 2110 IP Input	2-5
Packet Interval Profile Generator Toolset for ST 2022-6 IP Generation	2-5
Advanced Toolsets	2-6
SDI and Reference Toolset	2-6

Video and Audio Generation Toolset	2-6
Dolby Analysis Toolset	2-6
SDI Stress Testing Toolset	2-7
Media-related Toolsets	2-7
Advanced HDR Visualization and Analysis Toolset	2-7
UHD Formats Toolset	2-7
EUHD Mode Formats Toolset	2-8
Accessing the QxL Instruments	2-9
Overview of the QxL Main Screen	2-9
Using the Instrument Launch Menu	2-10
Using the Instrument Bar	2-12
Using the Instrument Bar Options Menu	2-12
Controlling the Audio Monitoring Source	2-13
System Time and Date Display	2-14
Using System State Presets and the Preset Bar	2-14
Reordering Presets	2-14
Renaming Presets	2-15
Other Preset Tasks	2-16
Overview of the Instrument Windows	2-17
Changing the Border Color of Instrument Windows	2-17
Working with the QxL Instruments	2-18
Selecting Submenu Options and Entering Values	2-19
Resizing an Instrument Window	2-20
Using the Instrument Scroll Bars and Scroll Control Menu	2-21
Using the Window Panel Slider Controls	2-22
Taking Screenshots	2-22
Working with Instrument Tabs	2-22
Using Instrument Dialogs	2-23
Using the Color Picker	2-24
Instrument Icon Quick Reference	2-26
3	3-1
Configuring and Checking the Unit	3-1
Qx Network and Automation	3-2
Overview	3-2
Using Virtual Network Computing (noVNC or VNC) for Remote Access	3-3
Instrument Menu Options	3-3
Using the Numeric Keypad to Enter Static IP Details	3-5
Setting the Time, Date and NTP Server	3-6
Setting-up the Display	3-8
Modifying the Display Options	3-8
Checking the Unit	3-10
Overview	3-10
Checking the System Health Status	3-10
Checking the Unit Licenses	3-11
Restarting the Unit	3-12
Restoring Factory Default Settings	3-13
Switching Between Analyzer Inputs	3-13
Resetting the SFP Configuration Database	3-15
Upgrading the Unit	3-17

Upgrading the System Software and Firmware	3-17
Remote Upgrade Using SFTP	3-18
Upgrading the Software Options	3-18
Managing Files with the USB File Manager	3-21
Overview	3-21
Opening the File Manager	3-21
Copying Files from the Unit to USB	3-22
Uploading Files from USB to the Unit	3-23
Deleting Files from the Unit	3-23
Packet Capture (PCAP)	3-24
Overview	3-24
Opening the PCAP Dialog	3-25
PCAP File Naming Syntax	3-27
USB Memory Stick Identification	3-28
Starting a PCAP Recording	3-29
Instrument Menu Options	3-30
Event Logging on the Unit	3-32
Overview	3-32
Available Event Logging Options	3-32
Remote Connection to the Unit	3-34
Overview	3-34
Available Functionality	3-35
Using Virtual Network Computing (VNC)	3-35
Enabling VNC on the Unit	3-35
Connecting to the Unit Using noVNC from a Web Browser	3-35
Using a Generic VNC Client to Connect Remotely to the Unit	3-37
Using SFTP	3-37
Connecting to the Unit Using SFTP	3-37
Using a Web Browser	3-38
Connecting to the Unit Using a Web Browser	3-38
4	4-1
IP Setup and Configuration	4-1
IP Connectors and Modules	4-2
Overview	4-2
IP Input and Output (ST 2022-6)	4-3
IP Input and Output (ST 2110)	4-4
IP Interfaces to the Unit	4-5
Overview	4-5
ST 2110 Input (Rx) Optical SFP Interfaces (Analyzer - IP Input)	4-5
ST 2110 Output (Tx) Optical SFP Interfaces (Generator or Monitor Flows - IP Output)	4-6
ST 2022-6 Input (Rx) Optical SFP Interface (Analyzer - IP Input)	4-6
ST 2022-6 Output (Tx) Optical SFP Interface (2022-6 Transmit IP Output)	4-6
Video Range Definitions for the Qx Series	4-7
System IO for IP Inputs	4-9
Overview	4-9
System IO for IP Inputs	4-9
SFP IP Network	4-11
Overview	4-11
Instrument Menu Options	4-11
LLDP Information	4-14

Overview	4-14
Instrument Menu Options	4-15
SFP (A, B) / (E, F) - Info	4-16
Overview	4-16
Instrument Menu Options	4-16
NMOS Status Overview & Configuration (ST 2110 IP Input)	4-17
Overview	4-17
Toggle Switches to Advertise NMOS Control Endpoints	4-20
Instrument Menu Options	4-20
NMOS Receivers - SDP (ST 2110 IP Input)	4-23
Overview	4-23
NMOS Receivers - SDP	4-23
Saving SDP Records to Disk	4-25
Instrument Menu Options	4-26
NMOS Receivers - IS05 (ST 2110 IP Input)	4-27
Overview	4-27
NMOS Receivers - IS05	4-27
Instrument Menu Options	4-29
NMOS Senders - SDP (ST 2110 IP Inputs)	4-30
Overview	4-30
NMOS Senders - SDP	4-30
Saving SDP Records to Disk	4-32
Instrument Menu Options	4-33
NMOS Senders - IS05 (ST 2110 IP Inputs)	4-34
Overview	4-34
NMOS Senders - IS05	4-34
Instrument Menu Options	4-35
SFP E/F - PTP Info (ST 2110 IP Input)	4-37
Overview	4-37
GM Info Tab	4-38
Qx Status Tab	4-39
PTP Messaging Tab	4-39
Instrument Menu Options	4-40
Video Timing & System Reference (IP Input)	4-44
Overview	4-44
Timing of ST 2022-6 IP Input: Decapsulated vs System Reference	4-45
Video Timing for ST 2110 IP Input	4-46
Overview	4-46
External Reference vs PTP Tab	4-46
Media Latency Tab	4-47
Instrument Menu Options	4-48
IP Receive - Flows	4-50
Overview	4-50
Instrument Menu Options	4-52
Manual Multicast Setup	4-54
Using the Instrument Controls	4-54
Flow Protocol Configuration(Flow Config)	4-56
Using the Flow Config Controls	4-56
NMOS Flow Configuration (NMOS Flow Config)	4-58
Analyzer - 2110 Format Setup(ST 2110 IP Input)	4-59

Overview	4-59
Video Tab Setup	4-59
Colorimetry Range and Bit Depth Support	4-62
Audio Tab Setup	4-62
Instrument Menu Options	4-64
AES IO Config (ST 2110 IP Input)	4-67
Overview	4-67
Instrument Menu Options	4-68
5	5-1
SDI Setup and Configuration	5-1
SDI Connections to the Unit (Factory Fitted Option)	5-2
Overview	5-2
SDI Input and Output Schematic (SDI Input/Output)	5-3
SDI Input / Output Configurations	5-5
SDI Inputs Using BNC Connectors (Factory-fitted Option)	5-6
SDI Outputs Using BNC Connectors (Factory Fitted Option)	5-7
Overview of SDI SFP Connections (Factory Fitted Option)	5-9
SDI Inputs Using SFP Connectors (Factory Fitted Option)	5-11
SDI Outputs Using SFP Connectors (Factory-fitted Option)	5-12
Video Range Definitions	5-12
System IO for SDI Input (Factory Fitted Option)	5-13
Overview	5-13
System IO for SDI Input	5-13
Instrument Menu Options	5-14
Generator Copy and SDI Out Configuration	5-17
AES IO Config (SDI (Factory Fitted Option) & ST 2022-6 IP Input/Output)	5-19
Overview	5-19
Instrument Menu Options	5-20
Video Timing & System Reference (SDI Input) (Factory Fitted Option)	5-21
Overview	5-21
Video Timing for SDI Input	5-21
SDI A vs System Reference	5-21
SDI Co-Timing (HD-SDI Inputs)	5-22
Instrument Menu Options	5-22
SFP (A, B) - Info (SDI Modes) (Factory Fitted Option)	5-24
Overview	5-24
Instrument Menu Options	5-24
6	6-1
Signal Generation Instruments	6-1
Generator (Video)	6-2
Overview	6-2
Generating ST 2110 IP Output	6-2
Configuring the Video Standard	6-3
Video Configuration Parameters (ST 2110 IP Output)	6-4
Range and Bit Depth Support for Generated Video Standards (ST 2110 IP Output)	6-4
Generating ST 2022-6 IP Output	6-6
Configuring the Video Standard	6-6
Video Configuration Parameters (ST 2022-6 IP Output)	6-7
Range and Bit Depth Support for Generated Video Standards (ST 2022-6 IP Output)	6-8
Generating SDI Output (Factory Fitted Option)	6-9

Configuring the Video Standard	6-9
Video Configuration Parameters (SDI Output (Factory-fitted Option))	6-11
Range and Bit Depth Support for Generated Video Standards (Optional SDI Output)	6-11
Generator Test Patterns	6-12
Including a Generator Text Identifier	6-15
User Test Patterns and Images	6-18
Using the Timecode Generator (ST 2110 IP Output)	6-19
Generator SDI Output Assignment (Optional SDI Output)	6-20
Insertion of ST352 Video Payload IDs (ST 2022-6 and SDI Modes)	6-22
Pathological Signal Insertion	6-22
Output Offset Adjustment (Optional SDI Output)	6-23
Generator (Audio) (ST 2022-6 IP & Optional SDI Output)	6-25
Overview	6-25
Audio Generator Configuration Dialog	6-30
Generator (Audio) (ST 2110 IP Output)	6-31
Audio Generator Configuration Dialog	6-35
2022-6 Transmit (SFP F) (ST 2022-6 IP Output)	6-36
Overview	6-36
Instrument Menu Options	6-37
Network Settings	6-37
2110 Transmit (ST 2110 IP Output)	6-39
Overview	6-39
Transmitting Generator Video and Audio Flows	6-40
Transmitting Monitor Video and Audio Flows	6-41
Reviewing the Tx tab	6-41
Reviewing the VID Tab	6-42
Reviewing the AUD1-2 and AUD3-4 Tabs	6-43
Reviewing the ANC Tab	6-43
Reviewing the MON Tab	6-44
Configuring the Generator Flows	6-46
Configuring the Generator Video Flows	6-47
Configuring the Generator Audio Flows	6-48
Configuring the Generator ANC Flows	6-49
Configuring the Monitor Flows	6-50
Configuring the Monitor Video and Audio Flows	6-51
7	7-1
Analysis Instruments	7-1
Analyzer - Video Standard (SDI & 2022-6)	7-2
Overview	7-2
Colorimetry Range and Bit Depth Support	7-3
Manual Configuration Override	7-3
Changing the Payload Identification Source	7-4
Instrument Menu Options	7-6
Stats - SDI In A, B, C, D (Optional SDI Input)	7-7
Overview	7-7
Stats - 2022-6 Receive (ST 2022-6 Input)	7-9
Overview	7-9
8	8-1
Network Analysis Instruments	8-1

Analyzer - 2022-7 Status (ST 2022-6 or ST 2110 IP Input)	8-2
Overview	8-2
Instrument Menu Options	8-4
SFP (E, F) - Network Stats	8-5
Overview	8-5
Instrument Menu Options	8-6
9	9-1
Content Analysis Instruments	9-1
Analyzer - Picture	9-2
Overview	9-2
Picture Aspect Ratios	9-3
Instrument Menu Options	9-6
Using Closed Captions	9-9
Using Dual Picture Instruments	9-10
Monitoring Closed Captions in Dual Picture Instrument Windows	9-11
Picture Cursor	9-12
Using the Picture Safe Areas	9-13
Displaying the Picture Safe Areas	9-14
Using the Message Center	9-14
SCTE 104 Packet Detection	9-16
Defining Source Input Names	9-16
Displaying the Ancillary Time Code (ATC)	9-17
On Video Loss (ST 2110 IP Input)	9-18
Analyzer - Waveform	9-19
Overview	9-19
About the Display Modes	9-21
Setting the Vertical and Horizontal Scales	9-21
Using Full-width Screen Mode	9-23
Using the Custom Display Mode	9-24
About the Waveform Modes	9-25
Using the Zoom and Panning Controls with the Mouse Scroll Wheel	9-27
Using Picture and Dataview with the Waveform Instrument	9-28
Using the Vectorscope with the Waveform Instrument	9-30
Using the Waveform Measurement Cursors	9-31
Setting a % Reference	9-33
Instrument Menu Options	9-35
Analyzer - Vectorscope	9-44
Overview	9-44
Instrument Menu Options	9-44
Analyzer - CRC Analysis (Optional SDI Input)	9-47
Overview	9-47
Instrument Menu Options	9-48
10	10-1
Audio Signal Analysis Instruments	10-1
Analyzer - Audio Channel Status	10-2
Overview	10-2
Raw Data Display	10-4
Instrument Menu Options	10-4
Analyzer - Audio Meters	10-5

Overview	10-5
Audio Group Metering (ST 2110 IP Input Only)	10-7
Using the Dolby E Decoder	10-8
Instrument Menu Options	10-11
Analyzer - Loudness Monitor	10-15
Overview	10-15
Summary Loudness Monitoring Process	10-17
Audio Assignment for Loudness Monitoring	10-17
Audio Meters for Loudness Inputs	10-19
Understanding the Loudness Meters and Values	10-19
True Peak Value	10-21
Momentary Loudness Value and Error Count	10-22
Short-term Loudness Value and Error Count	10-22
Integrated Loudness Value and Error Count	10-22
Loudness Range Value	10-22
Using the Loudness Controls	10-23
Using the Loudness History Graph	10-23
Resetting Loudness Values and Errors	10-24
Managing the Loudness Log Files	10-24
Retrieving the Loudness Log Files	10-25
Renaming the Loudness Logfile Base Name	10-26
Instrument Menu Options	10-27
Analyzer - Dolby Metadata	10-32
Overview	10-32
About Dolby Metadata	10-33
Dolby E	10-33
Dolby ED2	10-34
Instrument Menu Options	10-34
Dolby Program Metadata Display	10-36
Generic Information	10-36
Dolby Gain Metadata	10-36
Dolby Program Metadata	10-36
11	11-1
Data Analysis Instruments	11-1
Analyzer - Dataview	11-2
Overview	11-2
Instrument Menu Options	11-3
Analyzer - Ancillary Status	11-6
Overview	11-6
Instrument Menu Options	11-7
Analyzer - Ancillary Inspector	11-10
Overview	11-10
Instrument Menu Options	11-11
12	12-1
IP Network Traffic Measurement	12-1
IP Receive - Interpacket Timing	12-2
Overview	12-2
Interpacket Timing with ST 2022-6 IP Input	12-3
Instrument Menu Options (ST 2022-6 IP Input)	12-4
Interpacket Timing with ST 2110 IP Input	12-5

Instrument Menu Options (ST 2110 IP Input)	12-6
Analyzer - 2110-21 Status (ST 2110 IP Input)	12-8
Overview	12-8
Measurements and Instrument Menu Options	12-9
Measurement Prechecks	12-9
Network Compatibility Model Measurement (CINST)	12-9
Virtual Receiver Buffer Measurement (VRX)	12-11
Advanced Media Timing Measurement (ST 2110 IP Input)	12-14
Overview	12-14
Using the Advanced Video Timing Tab	12-15
Using the Advanced Media Latency Tab	12-15
Instrument Menu Options	12-17
13	13-1
12G Physical Layer Analysis	13-1
Eye - SDI In A (Physical Layer Analysis)	13-2
Overview	13-2
Instrument Menu Options	13-3
Jitter - SDI In A (Physical Layer Analysis)	13-5
Overview	13-5
Instrument Menu Options	13-6
14	14-1
Stress-testing Analysis Instruments	14-1
Advanced Generation Tools (Optional SDI Input - Stress Option)	14-2
Overview	14-2
Advanced Generation Tools Options	14-3
Eye - SDI In A (Optional SDI Input - Stress Option)	14-6
Overview	14-6
Using the Eye Time Cursors	14-7
Instrument Menu Options	14-8
PRBS Analysis (Optional SDI Input - Stress Option)	14-11
Overview	14-11
Instrument Menu Options	14-11
15	15-1
HDR Analysis Instruments	15-1
Advanced HDR Toolset	15-2
Overview	15-2
HDR Test Patterns	15-2
Transfer Curve and Colorimetry Overrides	15-3
Analyzer - CIE Chart	15-4
Overview	15-4
Instrument Menu Options	15-4
HDR Heat-map (False Color Overlay)	15-6
HDR Instrument Options	15-7
16	16-1
Additional System Information	16-1
Using the REST API for Remote Access	16-2
Activating the REST API	16-2
Connecting Using the REST API	16-2

Using REST API Requests	16-3
Using REST API Requests with ST 2022-6 IP Input	16-3
Using REST API Requests with ST 2110 IP Input	16-4
Using REST API Requests with Optional SDI Input	16-5
Using the Advertise NMOS Control Endpoints Toggle Switches	16-6
Affected NMOS Resources on the Unit: /x-nmos/node/v1.3/self	16-6
Affected NMOS Resources on the Unit: /x-nmos/node/v1.3/devices	16-8
Driver Calibration	16-9
Overview	16-9
SDI Output Calibration Steps	16-9
A	A-1
Technical Specifications	A-1
Power	A-2
External Locking Reference	A-2
SDI Instrument Output	A-2
HDMI Instrument Output	A-2
USB	A-3
Networking	A-3
Rear panel D26	A-3
GPIO	A-5
AES I/O	A-5
Longitudinal Timecode (LTC)	A-5
Analog Audio Output	A-5
B	B-1
Advanced Media Timing Information	B-1
Overview	B-2
Advanced Media Timing Definitions	B-2
Video IP Packet Timing Schematics	B-2
Measurements in the Video Timing Tab	B-5
Video Timing (First Packet Time) Measurement	B-5
Margin Measurement	B-7
RTP Offset Measurement	B-7
Measurements in the Media Latency Tab	B-8
Media Latency Measurement	B-8
RTP Clock and Timestamps	B-9
RTP Clocks per Timestamp Quotient (RTP / TS)	B-10
Working with Non-integer Frame Rates	B-11
Un-locked Media Sources	B-12
Sources Not Locked to PTP	B-12
C	C-1
On-going Development	C-1
SMPTE SDTV and UHD TV: SDI Physical Layer Tolerances	C-1
D	D-1
Supported SFPs	D-1
D	D-1
Supported Video Standards	D-1
SD/HD/2K Supported Formats	D-1
4K/UHD Supported Formats	D-6

Getting Started

This chapter describes how to connect your unit to get it up and running and includes the following sections:

- [Getting Started Quick Reference](#)
 - [What's in the Box](#)
- [Overview of the Rear Panel Connectors](#)
- [Connecting Essential Cables to the Unit](#)
- [Powering-up the Unit](#)
- [IP and SDI Connections to the Unit](#)
- [Powering-down the Unit](#)

Getting Started Quick Reference

What's in the Box?

On receipt of your shipment, proceed as follows:

1. Check the external packaging for any visible signs of damage.
Should you find any damage, contact the courier immediately.
2. Carefully open the packaging and check that it contains the following standard items:
 - One QxL unit; either:
 - PHABRIX QxL chassis: **PHQXL** (with 10 GbE IP Rasterizer, Analyzer only) or
 - PHABRIX QxL chassis: **PHQXL01-3G** (with 10 GbE IP/SDI Rasterizer, Analyzer only) or
 - PHABRIX QxL chassis: **PHQXL01E-3G** (with 10 GbE IP/SDI Rasterizer with Eye and Jitter, Analyzer only.)
 - One XLR power cord.
 - One AC power adapter (90 - 264 VAC, 120 W)
 - PHABRIX USB stick containing standard software with any ordered software options and User Manual in PDF format.
3. Check all optional items against your order form or invoice.
4. If you suspect optional items are missing, contact your Distributor or PHABRIX support at: <https://phabrix.com/support/>
5. Complete the Product Registration form available at: <https://phabrix.com/support/product-registration>

Mounting the Unit

You can install the QxL as a standalone unit on a desktop or rack-mount the unit or units using one of the following optional rack-mounting kits:

- For a single unit, use both options:
 - 19 inch rack mount kit (**PHQXK1**)
 - Mounting kit - 9.5 inch rack (**PHQXK3**)
- For two units:
 - 19 inch rack mount kit (**PHQXK2**)

Desktop Mounting

To desk mount a standalone unit, place it on a clean, level dust-free surface and connect the cables as described in the section [Connecting Essential Cables](#). Ensure that the unit is positioned to allow sufficient airflow for cooling purposes.

Rack Mounting

To rack-mount one or more units in a 19 inch rack, follow the procedure in the instruction guide included with the mounting hardware. Ensure that the unit(s) have an unrestricted airflow and access to the power connectors in the rack.

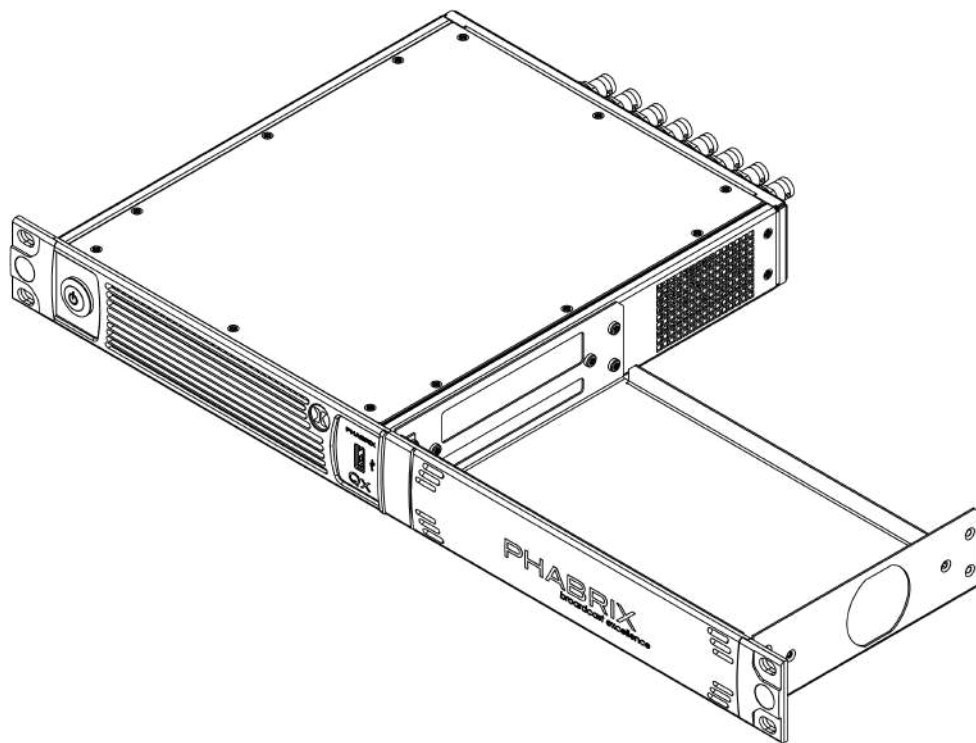

Figure 1-1: Single Rack Mount Tray with Cover (Option PHQXK1)

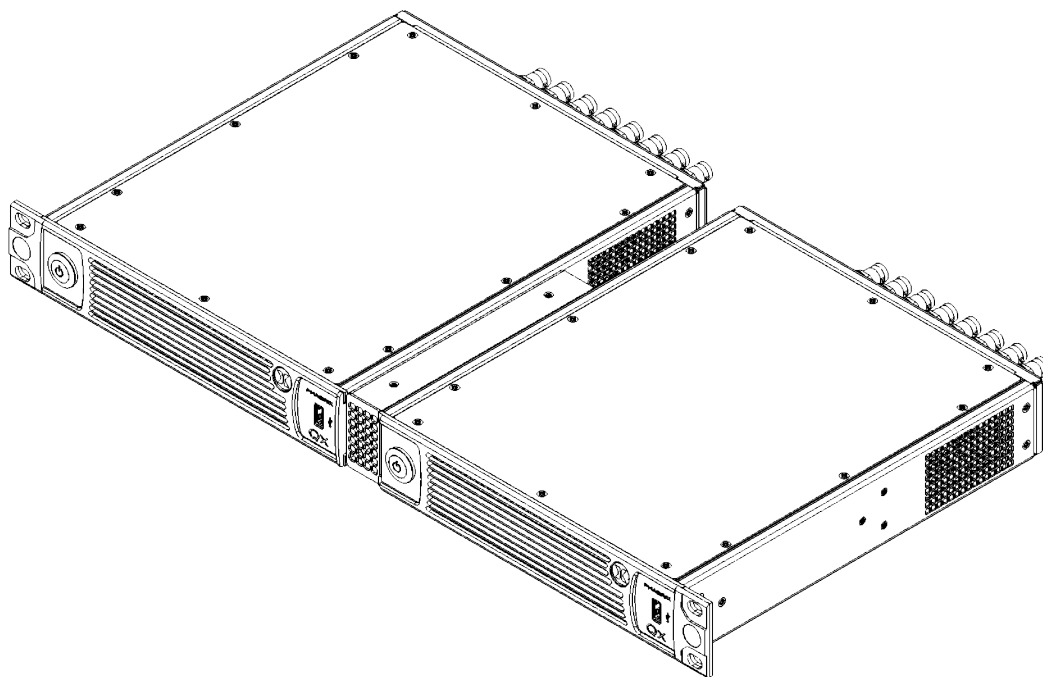

Figure 1-2: Dual Rack Mount (Option PHQXK2)

Overview of the QxL Rear Panel Connectors

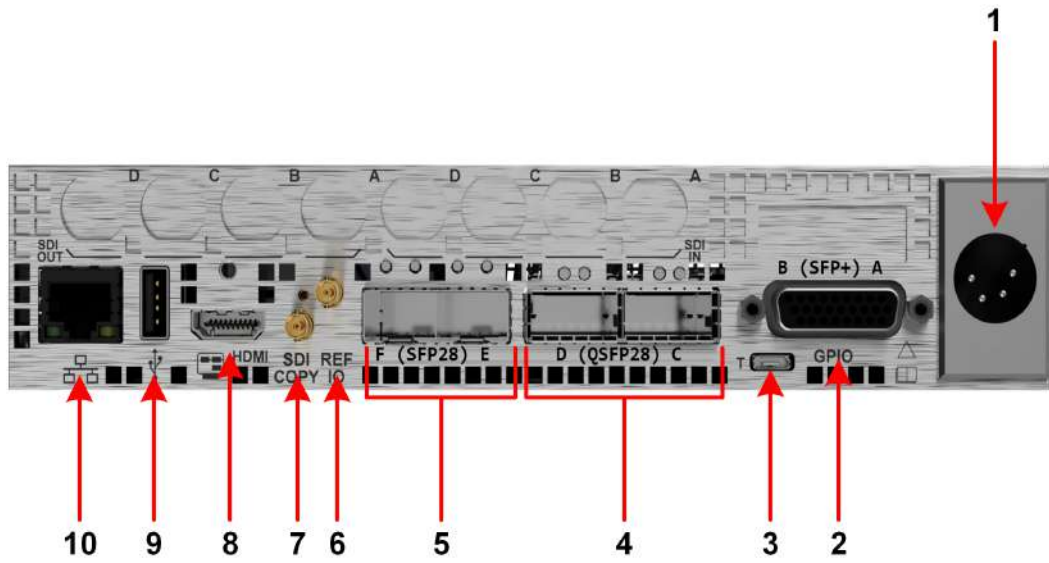

Figure 1-3: QxL Rear Panel Connectors (Standard)

The rear panel connectors are described in the following table:

Table 1-1 : Key to Rear Panel Connectors

No.	Connector	No.	Connector
1	AC Power Socket (10 - 18 V)	6	Reference IO 75R Micro High Density HD-BNC
2	Stereo Audio Out LTC In, 8x GP I/O, 4x AES I/O For details of the GPIO connector pinouts, see Appendix A.	7	SDI Copy Instrument Output, 75R Micro HD- BNC Formats: 1080p 50, 59.94, 60 3G-SDI
3	Micro USB Factory Service	8	HDMI Instrument Output (To 1920x1080p 50, 59.94, 60)
4	Two QSFP28 Cages (QSFP28 C and QSFP28 D) (Reserved; not to be used)	9	USB 2.0 Port
5	Two SFP28 Cages (25GE, 10GE) (SFP28 E and SFP28 F) (Standard)	10	Control Network / Management Port 1000 Base T

Note: The SFP cages include link light indicators (if fitted).

Note: The LTC interface is not available in this software release.

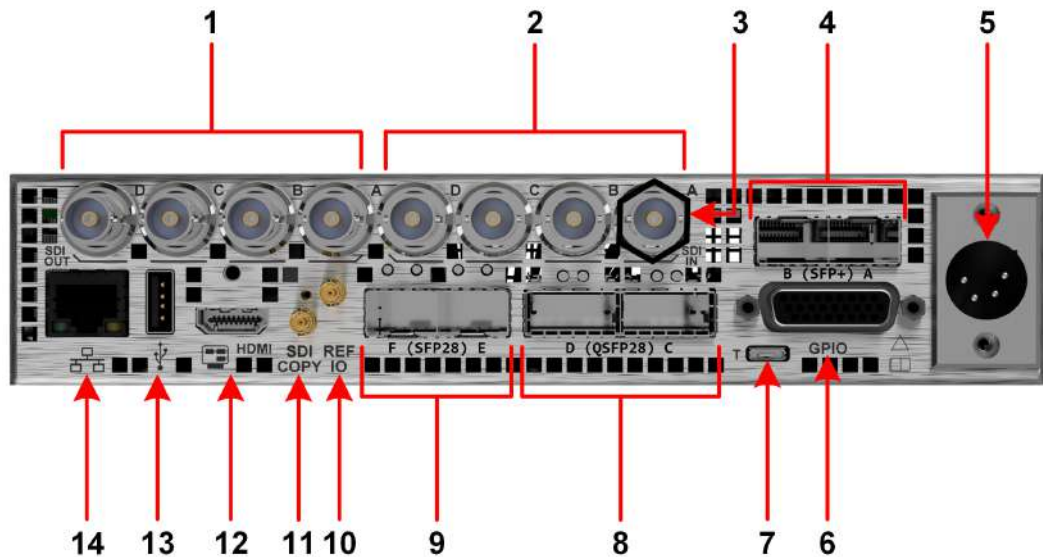

Figure 1-4: QxL Rear Panel Connectors (Including Factory Fitted SDI Option)

The rear panel connectors are described in the following table:

Table 1-2 : Key to Rear Panel Connectors (With SDI Option)

No.	Connector	No.	Connector
1	SDI Generator, Duplicate SDI or Input SDI Loop Outputs Supported formats: HD, 3G, 6G, 12G. SDI 75 R BNC Connectors x 4 (Optional SDI)	8	Two QSFP28 Cages (QSFP28 C and QSFP28 D) (Optional)
2	Analyzer SDI Inputs Supported formats: SD (SDI IN A Only), HD, 3G, 6G, 12G SDI 75 R BNC Connectors x 4 (Optional SDI)	9	Two SFP28 Cages (25GE, 10GE) (SFP28 E and SFP28 F) (Standard)
3	SDI In A Eye Signal (fitted with Black Nut.) Supported formats: SD, HD, 3G, 6G, 12G (Optional SDI)	10	Reference IO 75R Micro High Density HD-BNC
4	(SFP+) MSA/Non-MSA 12 GbE copper or fiber (SFP+A and SFP+B) (Optional SDI)	11	SDI Copy Instrument Output 75R Micro High Density HD-BNC Formats: 1080p 50, 59.94, 60 3G-SDI
5	AC Power Socket (10 - 18 V)	12	HDMI Instrument Output (To 1920x1080p 50, 59.94, 60)
6	Stereo Audio Out LTC In, 8x GPI I/O, 4x AES I/O For details of the GPIO connector pinouts, see Appendix A.	13	USB 2.0 Port
7	Micro USB Factory Service	14	Control Network / Management Port 1000 Base T

Note: The SFP cages include link light indicators (if fitted).

Note: The LTC interface is not available in this software release.

Connecting Essential Cables to the Unit

After unpacking your QxL unit, you can get it up and running either as a standalone instrument on a desktop, or mounted in a rack, using the appropriate mounting kit, if ordered.

Proceed as follows to obtain an output to a video display using the connectors shown in [Figure 1-5](#) below:

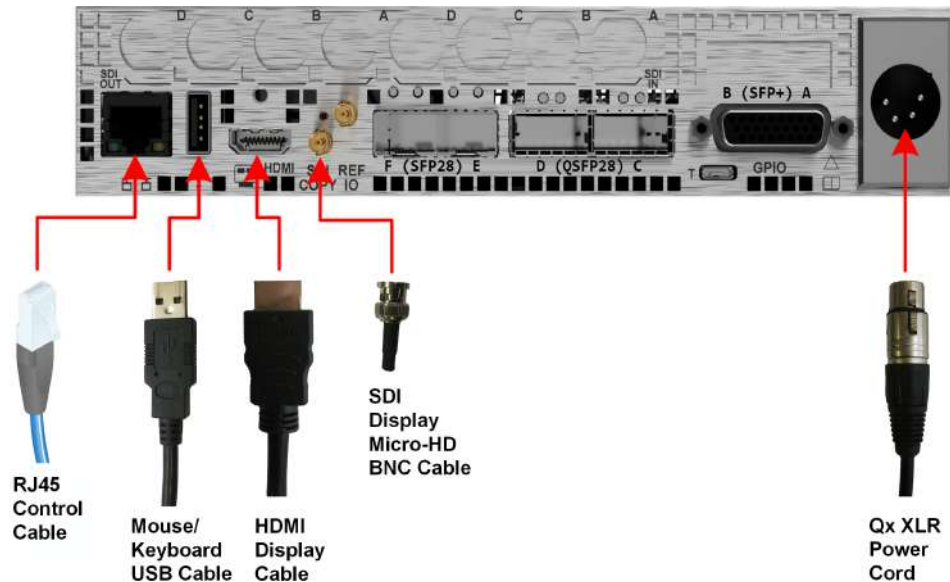

Figure 1-5: QxL Minimum Rear Panel Connectors

Connect the cables to the rear panel as follows:

1. Connect a suitable 1920 x 1080 capable monitor to either the HDMI instrument output or the SDI Copy instrument output. Both display outputs carry the selected audio monitoring channel/pair. The monitor output can be configured for 1080p60, 1080p59.94 or 1080p50 frame rates using the Display Options submenu available from the **Instrument Launch Menu**. Either:
 - Connect an HDMI type A cable to the female HDMI connector on the rear of the QxL and the other end to your video monitor to obtain the instrument display, or
 - Connect an SDI micro-HD BNC cable to the SDI Copy instrument output connector on the rear of the QxL and the other end to your video monitor to obtain the instrument display.

Note: The HDMI output supports auto DVI mode over HDMI to connect DVI KVM Extenders for remote installations.

2. Connect USB mouse/keyboard cables to the USB connectors on the front or rear of the unit for mouse and keyboard control.
3. Connect an RJ45 cable to the management port. This enables you to access and control the unit remotely and to set the unit time using NTP.
4. Connect the four-pin, XLR power connector, on the power cord supplied with the unit, to the power socket on the unit.
5. Connect the plug on the other end of the power cord to a mains AC power outlet.
6. Switch on the power.
The unit will automatically start to power-up.

These are the minimum connections you need to power-up the unit, obtain an output to the connected video display and control the user interface.

Powering up the QxL

Once connected to a power source, press the Power button on the front panel of the unit. You should see the status LED, behind the power button, light in the following sequence:

- **Blue:** Initial Start-up
- **Yellow (Blinking):** Configuring
- **White:** Running

When the you first press the Power Button on the front panel, the unit's fans will cycle for 20 to 30 seconds at high speed as the system boots, then settle to their normal operating speed.

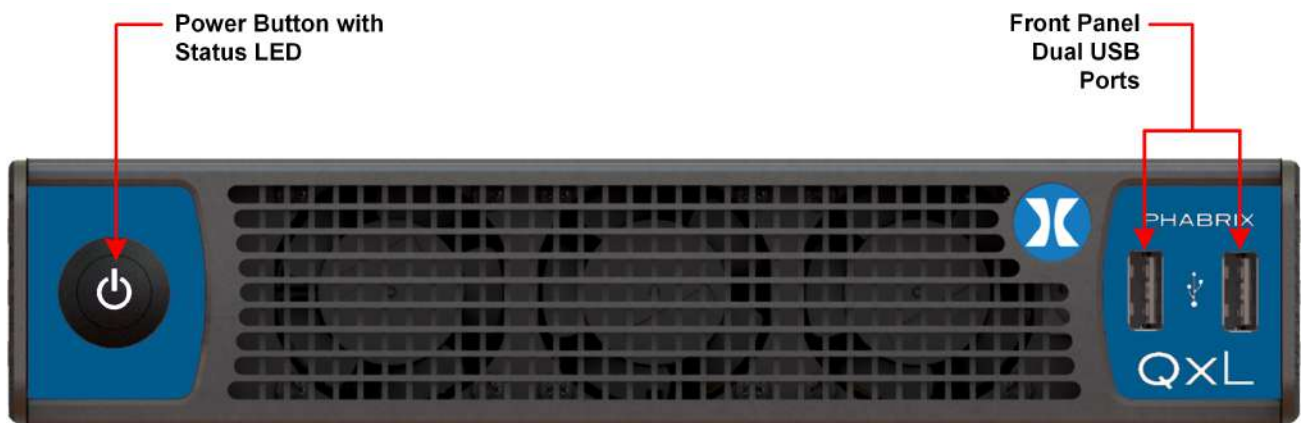

Figure 1-6: QxL Front Panel

During standard operation, the Power button LED provides an indication of the current status of the unit. The following table lists some of the LED colors you may see and provides a description of the unit's status at that point.

Table 1-3 : QxL Power LED Status Indicators

LED Color	Description
White	QxL running well.
Magenta	QxL upgrading software / firmware.
Cyan	QxL busy.
Blue	QxL busy, for example, during Initial start-up sequence.
Yellow	QxL busy, for example, configuring modules and checking licenses. Do not switch off.
Red	Fault. Contact PHABRIX Support if red LED stays lit or continuously flashes red.

IP and SDI Connections to the Unit

Standard IP-Only Configuration

As standard, the QxL is supplied fitted with two SFP28 cages, labeled **SFP28 E** and **F**, supporting media data transfer speeds of up to 25 GbE.

You can choose either to use your own generic SFP+/SFP28 transceiver modules to obtain media data transfer speeds of 10 GbE or 25 GbE respectively, or use the SFPs supplied with the following PHABRIX options:

- With option **PHSFP-10GE-SR/-LR**, insert SFP+ transceiver module(s) for a 10 GbE link
- With option **PHSFP-25GE-SR/-LR**, insert SFP28 transceiver module(s) for a 25 GbE link.

Note: Multirate SFPs are not supported.

For ST 2110 IP input, both **SFP28 E** and **SFP28 F** are available for data decapsulation (receiving). In addition, for ST 2110 IP inputs a stable source of ST 2059 precision time protocol (PTP 1) must be available on the network to which **SFP28 E** is connected. A second, optional, PTP source (PTP 2) can also be applied to **SFP28 F**.

For ST 2022-6 IP input, both **SFP28 E** and **SFP28 F** are available for data decapsulation (receiving).

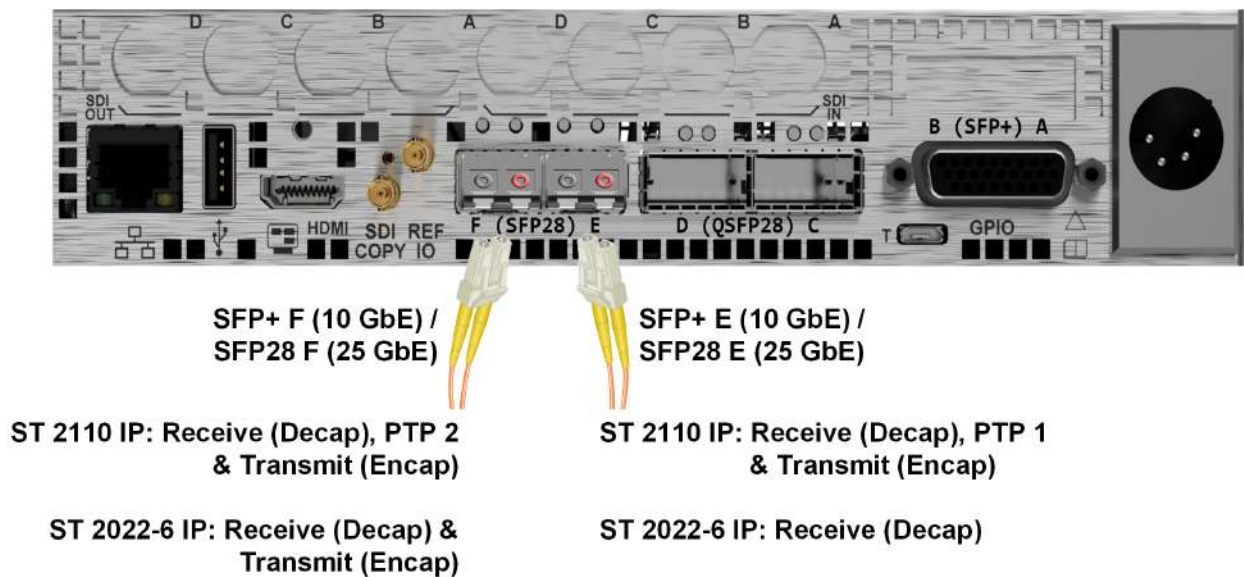

Figure 1-7: Connecting an IP-Only QxL (Option: PHQXL) Using SFP Connectors

For ST 2110 IP output, both **SFP28 E** and **SFP28 F** are available for data encapsulation (transmitting).

For ST 2022-6 IP output, **SFP28 F** is available for data encapsulation (transmitting).

Optional SDI Configuration

In addition to the standard QxL model (**PHQXL**) you can order the QxL with either of the following two factory-fitted SDI options:

- Option **PHQXL01-3G** provides a Mezzanine interface board with eight SDI BNC Connectors (four inputs and four outputs) and two SDI-only SFP+ cages **SFP+ A** and **SFP+ B**
- Option **PHQXL01E-3G** provides a Mezzanine interface board with eight SDI BNC Connectors (four inputs and four outputs) and two SDI-only SFP+ cages **SFP+ A** and **SFP+ B** together with Eye and Jitter analysis on the **SDI In A** BNC connector.

- Two further return-to-factory upgrade options **PHQXLM-01** and **PHQXLM-01E** are available to add SDI or SDI with Eye and Jitter respectively.

When an SDI option is fitted, together with the Audio/Video Test Signal Generator software option (**PHQXLO-GEN**), the unit includes both Generator and Analyzer, which enables you to loop the Generator outputs back to the corresponding Analyzer inputs as shown below.

This guide assumes that you connect the unit to itself as shown in the following figure for SDI using the BNC connectors as follows:

- For **single** link SDI standards, connect **SDI Out A** to **SDI In A**.
- For **dual** link SDI standards, also connect **SDI Out B** to **SDI In B**.
- For **quad** link SDI standards, also connect **SDI Out C** to **SDI In C** and **SDI Out D** to **SDI In D**.

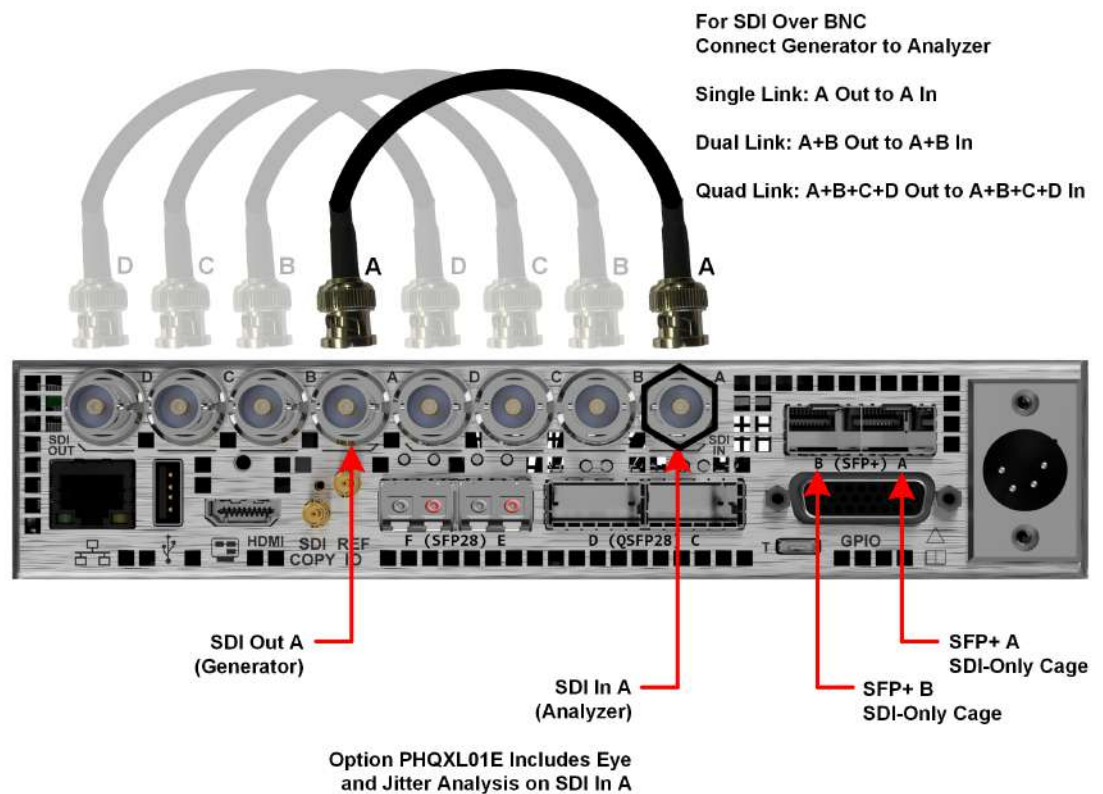

Figure 1-8: Connecting the Internal Generator to the Analyzer Using BNC Connectors

Powering-down the Unit

To power-down the unit, press the Power Button on the front panel and the unit will shutdown after 10 seconds. To shutdown immediately, press the power button twice or click the **SHUT DOWN NOW** button displayed in the Shutdown window. To stop a shutdown, click **Cancel**.



Figure 1-9: Unit Shutdown Dialog

Working with the User Interface

This chapter describes how to use the key features of the user interface and includes the following sections:

- [Overview of the Product Structure](#)
- [Overview of the Main Screen](#)
- [Using the Instrument Launch Menu](#)
- [Using the Instrument Bar](#)
- [Overview of the Instrument Windows](#)
- [Working with the Instruments](#)
 - [Working with Instrument Tabs](#)
- [Icon Quick Reference](#)

Overview of the Product Structure and Options

Introduction

The QxL is a highly-flexible, modular device, which you can custom-build from a diverse palette of both standard and optional components.

This chapter introduces these components - the Toolsets, Instruments and Options available with the QxL - which you can combine to create a solution that meets the specific demands of your media test and measurement environment.

Toolsets and Instruments

In essence, each **Instrument** is a standalone utility or application designed to provide a specific solution to a test and measurement task. For example, the QxL provides Instruments to analyze the picture display or waveform; generate video or audio test signals; decode auxiliary data; provide status information and so on. You can adapt or modify the functioning of all Instruments using the configuration options available in an Instrument's right-click option menus.

The QxL **Toolsets** group together Instruments at a higher functional level to assist with defining your ideal configuration.

It is important to note that Toolsets outside the standard Toolset(s) require additional **Options** (hardware or software) to enable you to install the license for that Toolset. In addition, you may need to switch the input or output between SDI (via BNC or SFP) or IP (ST 2022-6 or ST 2110 via SFP) to use some of the Instruments or Toolsets described in the following sections.

Note: The current software version (6.0) introduces a combined operating mode which allows you to switch seamlessly between IP and SDI¹ inputs and outputs without rebooting the unit.

Some instruments are designed specifically for IP source input or output (either ST 2022-6 or ST 2110), others for optional SDI source input or output, while others are generic and can be used with all inputs / outputs.

As standard, the QxL offers a flexible, user-defined, Instrument layout displaying up to 16 Instrument windows simultaneously. Furthermore, by saving different operational configurations for specific tasks as **Presets**, you can switch easily between bespoke set-ups for rapid fault diagnosis, compliance monitoring and product development.

¹Factory-fitted option

Standard QxL Toolsets

Standard Toolset

The standard or core Toolset provides the following Instruments and associated utilities:

- [Analyzer - Ancillary Status](#)
- [Analyzer - Audio Channel Status](#)
- [Analyzer - Audio Meters](#)
- [Analyzer - Loudness Monitor](#)
- [Analyzer - Picture and Analyzer - Picture Copy](#)
- [Analyzer - Vectorscope](#)
- [Analyzer - Waveform](#)
- [Analyzer - Dataview](#)
- [Analyzer - ANC Inspector](#)
- [Event Logging](#)
- [Network and Automation](#)
- [System IO for IP Inputs](#)
- [AES IO Configuration](#)
- Supporting standard utilities:
 - [USB File Manager](#)
 - [VNC Remote Connection](#)
 - [REST API](#).

Standard IP Monitoring Toolset for ST 2110 and ST 2022-6 IP Inputs

The Standard IP Monitoring Toolset for ST 2110 and ST 2022-6 IP inputs provides the following Instruments and tools:

IP Monitoring Toolset Instruments	SMPTE Standard Supported by Instrument	
	ST 2110 Input	ST 2022-6 Input
Analyzer - 2022-7 Status	Yes	Yes
Analyzer - 2110 Format Setup	Yes	N/A
Analyzer - LLDP Data	Yes	Yes
IP Media Latency tool (Tab in Video Timing & System Reference Instrument)	Yes	N/A
IP Receive - Flows	Yes	Yes
NMOS Group including the following instruments: <ul style="list-style-type: none"> • NMOS Status Overview and Configuration • NMOS Receivers - IS05 • NMOS Receivers - SDP • NMOS Senders - IS05 • NMOS Senders - SDP 	Yes	N/A
SFP E / F - PTP Info (Input independent)	Yes	Yes
SFP A / B or E / F - Info	Yes	Yes
SFP E / F - Network Stats	Yes	Yes
SFP IP Network	Yes	Yes
Stats - 2022-6 Receive	N/A	Yes

Additional IP Toolsets

IP Network Traffic Toolset for Standards ST 2110 and ST 2022-6

The IP Network Traffic Measurement Toolset for SMPTE standards ST 2110 and ST 2022-6 provides the following Instruments and tools:

Note: This Toolset requires the software option: **PHQXLO-IP-MEAS**.

IP Network Traffic Analysis Toolset Instruments	SMPTE Standard Supported by Instrument	
	ST 2110 Input	ST 2022-6 Input
IP Receive - Interpacket Timing	Yes	Yes
Analyzer - 2110-21 Status	Yes	N/A
Advanced PTP Media Timing tool (Tab in Video Timing & System Reference Instrument)	Yes	N/A

IP Packet Capture (PCAP) Toolset for ST 2110 IP Input

The IP PCAP Toolset for ST 2110 IP input provides the following utility for network analysis:

Note: This Toolset requires the software option: **PHQXLO-IP-PCAP**.

- [IP PCAP Capture](#) utility

Packet Interval Profile Generator Toolset for ST 2022-6 IP Generation

The ST 2022-6 Packet Interval Profile Generator Instrument Toolset provides the following Instrument:

Note: This Toolset to generate ST 2022-6 IP output requires the software options: **PHQXLO-GEN** and **PHQXLO-IP-NGT**.

- [2022-6 Transmit \(SFP F\)](#) (ST 2022-6 Output Only).

Advanced Toolsets

SDI and Reference Toolset

Note: This Toolset requires one of the factory-fitted, hardware chassis options: **PHQXL01-3G** or **PHQXL01E-3G** which include the Mezzanine boards fitted with SDI BNC connectors and SDI SFP+ cages.

The SDI and Reference Toolset provides the following Instruments:

- [Eye - SDI In A](#)
- [Jitter SDI In A](#)
- [Analyzer - CRC Analysis](#)
- [Analyzer - Video Standard \(SDI & 2022-6\)](#)
- [Stats - SDI In A, B, C, D](#)
- [System IO for SDI Input](#)
- [Video Timing & System Reference \(SDI\)](#).

Video and Audio Generation Toolset

The Video and Audio Test Signal Generation Toolset provides the following Instruments:

Note: This Toolset requires the software option: **PHQXLO-GEN**.

- [Generator](#) (Includes configuration dialogs for [Video](#) and [Audio](#) signal generation)
- [2110 Transmit](#) (ST 2110 IP Output Only)

Dolby Analysis Toolset

The Dolby Analysis Toolset provides the following Instrument:

Note: This Toolset requires the software option: **PHQXLO-DOLBY**.

- [Analyzer - Dolby Metadata](#)
- [Dolby E Decoder](#) available for selection in the **Analyzer - Audio Meters** instrument.

SDI Stress Testing Toolset

The SDI Stress Testing Toolset provides the following Instruments and tools:

Note: This Toolset requires the SDI stress testing software option: **PHQXLO-SDI-STRESS** and requires an **SDI** source input.

Note: This Toolset requires one of the hardware chassis options: **PHQXL01-3G** or **PHQXL01E-3G** which include the Mezzanine boards fitted with SDI BNC connectors and SDI SFP+ cages.

- [Advanced Generation Tools](#) (Additional submenu item in **Generator** Instrument)
- [Advanced Eye Analysis](#) (Additional submenu item in **Eye - SDI In A** Instrument)
- [PRBS Analysis](#)
- [Pathological Detection Tools](#) (Additional submenu item in **Generator** Instrument)
- Sync bit removal option in **Dataview** Instrument.

Media-related Toolsets

Advanced HDR Visualization and Analysis Toolset

The Advanced High Dynamic Range (HDR) Toolset provides the following Instruments and tools:

Note: This Toolset requires the software option: **PHQXLO-HDR**.

- [False Color Highlighting](#) (Additional submenu item in **Analyzer - Picture** and **Analyzer - Picture Copy** Instruments)
- [Analyzer - CIE Chart](#).
- HDR Waveform and Gen (Additional submenu items in **Generator** (Video) and **Analyzer - Waveform** Instruments).

UHD Formats Toolset

The UHD Formats Toolset provides the following:

Note: This Toolset requires the software option: **PHQXLO-UHD**. For SDI inputs, this toolset requires one of the hardware chassis options: **PHQXL01-3G** or **PHQXL01E-3G**. For ST 2110 inputs, this toolset requires **PHQXLO-IP-25G**.

- Support for UHD/4K formats for both IP and SDI (including some HD/2K extended mode formats)

EUHD Mode Formats Toolset

The UHD Extended Mode Formats (EUHD) Toolset provides the following:

Note: This Toolset requires the software options: **PHQXLO-UHD** and **PHQXLO-EUHD**.

- Support for analysis of extended mode UHD/4k formats: YCbCr/RGB 444; 8-/10-/12-bit; 47.95P - 60P.

Accessing the QxL Instruments

Overview of the QxL Main Screen

On first powering-up the unit, you will see the following screen displayed:

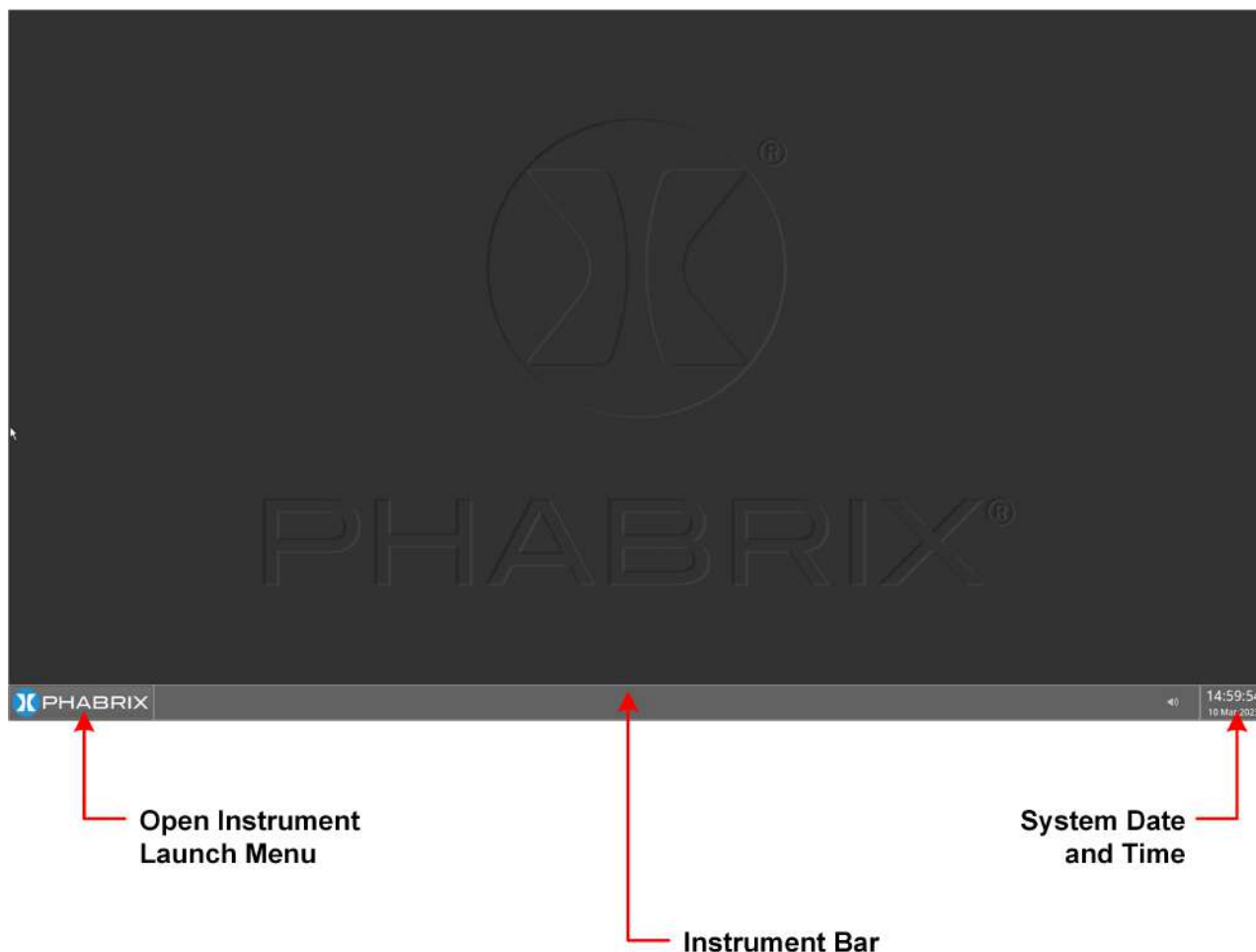

Figure 2-1: Initial QxL Screen Following Start-up

The Instrument Launch Menu gives you access to all the test and measurement instruments available through your license(s).

To open the Instrument Launch Menu, click the PHABRIX button in the bottom-left corner of the **Instrument Bar**.



Figure 2-2: PHABRIX Button to Open the Instrument Launch Menu

Using the Instrument Launch Menu

The Instrument Launch Menu provides access to the test and measurement Instruments and other system menus available with your unit. Open the Instrument Launch Menu by clicking the PHABRIX button in the bottom-left corner of the screen.

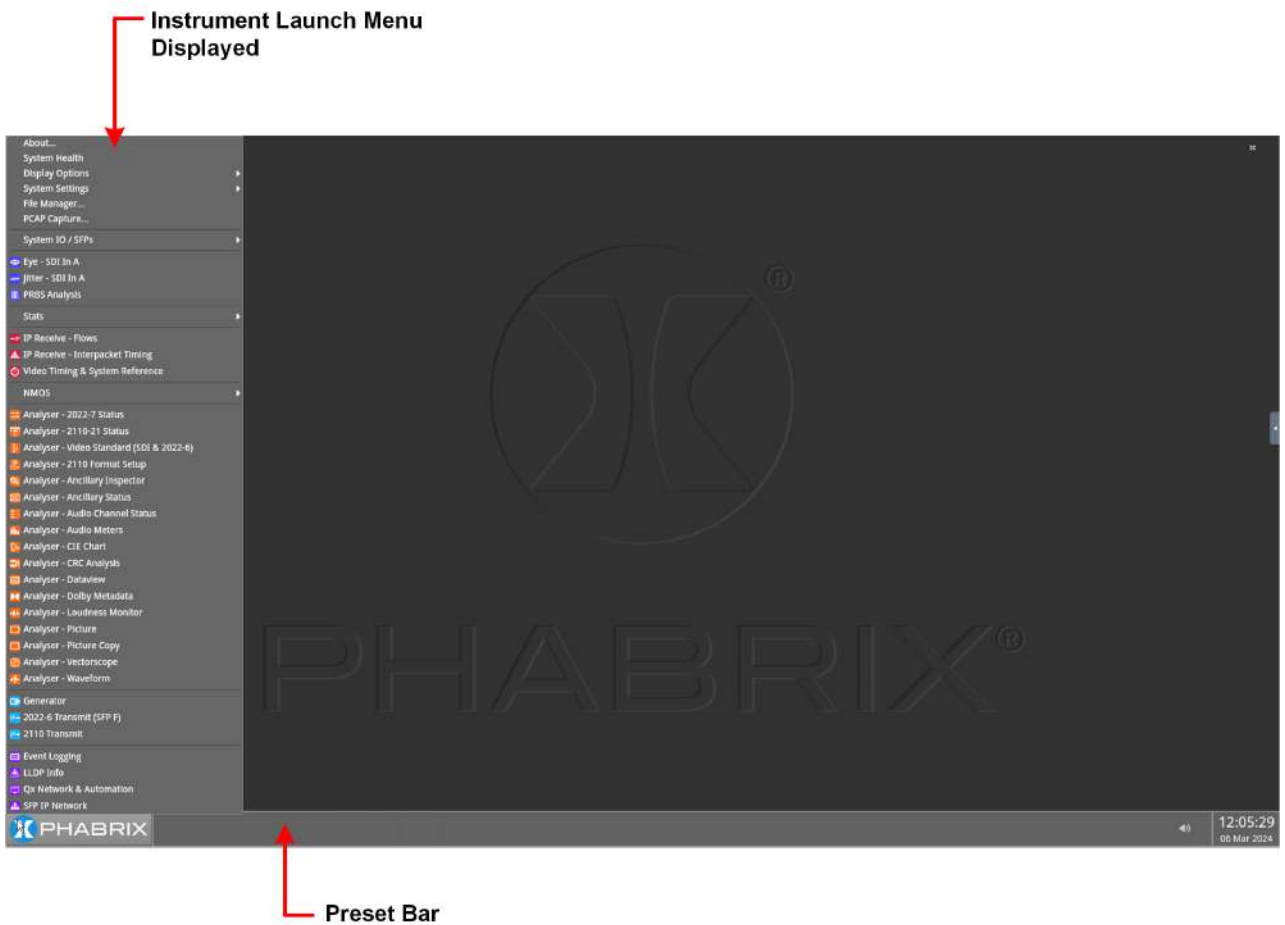

Figure 2-3: Open Launch Menu

Instruments for all possible inputs are available from the Launch Menu, some included in sub-menus.

On start up, you will see the following Launch Menu, displayed by default:

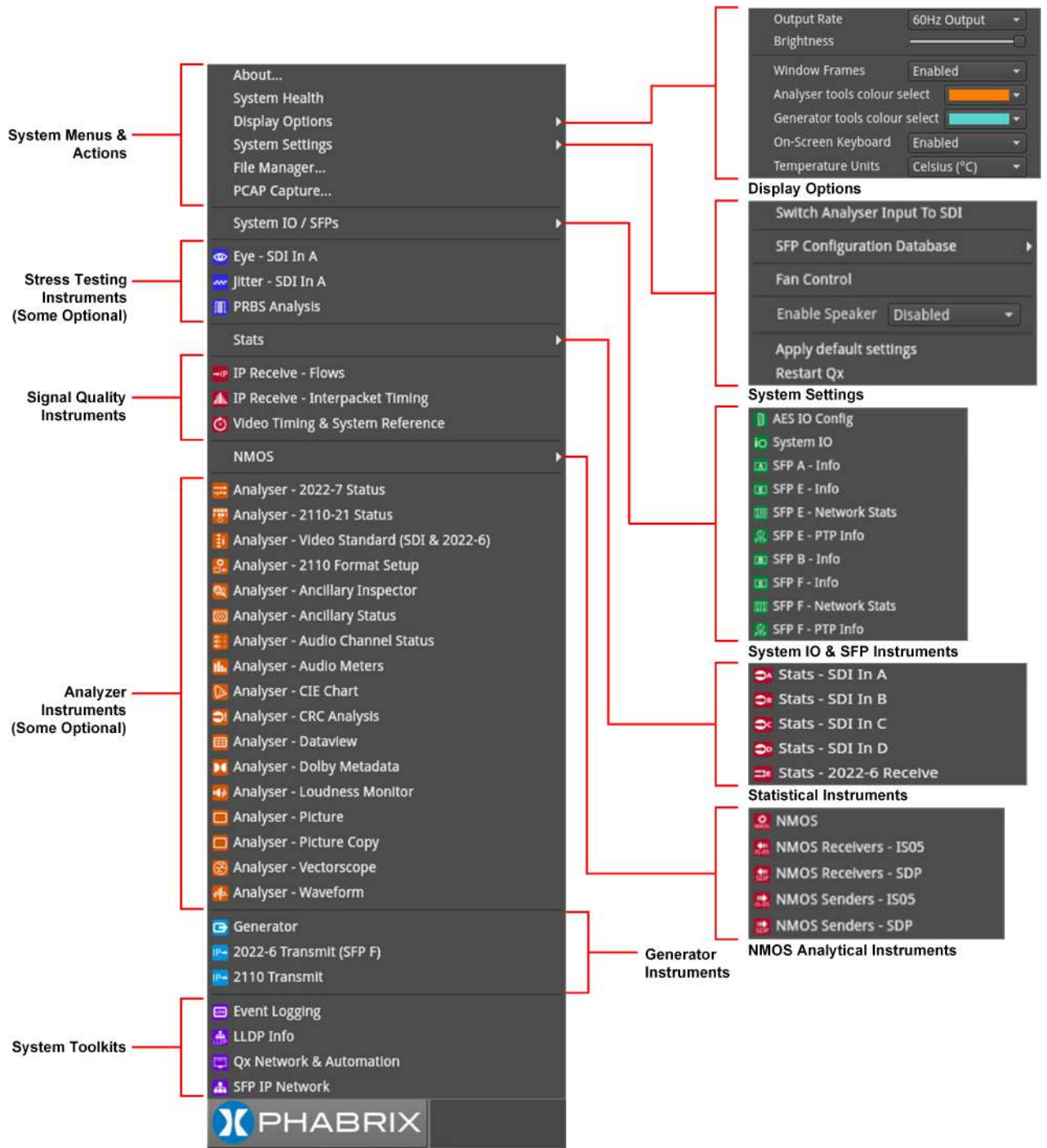

Figure 2-4: Launch Menu Showing Submenus

Each Instrument available in the menu is listed alongside its designated icon. Options listed at the top of the menu, without icons, provide access to system menus and actions, such as switching the analyzer input or reverting to default settings.

When you select an instrument from the Instrument Launch menu, the Instrument window opens and its icon is displayed in the Instrument Bar at the bottom of the screen.

As you select each new instrument, the QxL adds another icon to the Instrument Bar.



Figure 2-5: QxL Instrument Bar Showing Icons for Active Instruments

Using the Instrument Bar

As you open an Instrument from the Instrument Launch Menu, the unit adds the corresponding icon for that Instrument to the Instrument Bar. To identify the Instrument corresponding to an icon, simply hover the mouse over the icon and the unit displays a tooltip showing the name of that Instrument.

You can use the Instrument icons to bring a particular Instrument window into focus, a useful feature if you have a number of Instruments overlapping on the display. On finishing with an Instrument, right-click its icon and select the option **Close "Instrument Name"**.

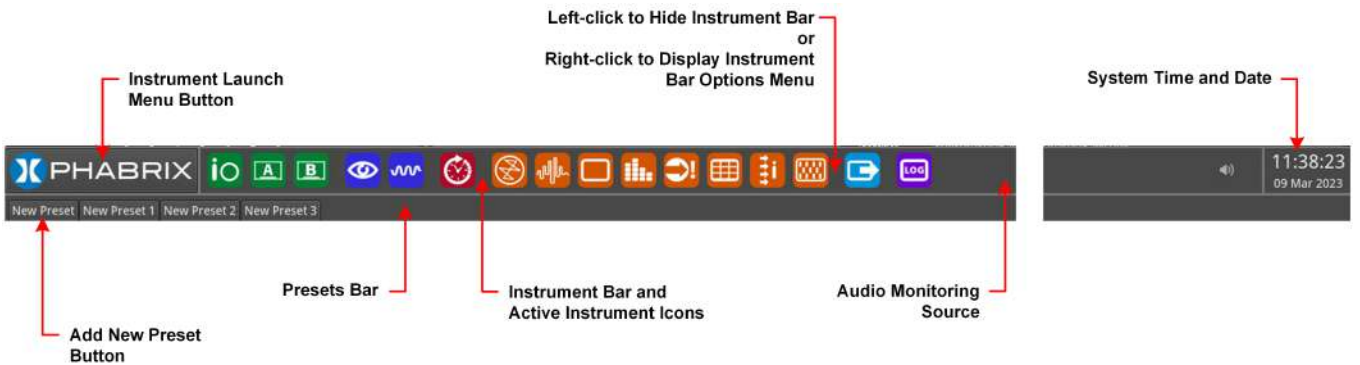

Figure 2-6: Key Components of the Instrument Bar

To give Instruments in the lower part of the display more screen space, you can hide the Instrument Bar by left-clicking in any of the blank sections of the Bar. Move the cursor back to the bottom of the screen, at any time, to redisplay the Instrument Bar.

In addition, the unit displays any configuration presets you define in a **Presets Bar**, below the Instrument Bar, depending on the setting of the option **Auto-hide Presets** in the Instrument Bar Options menu. For more information on saving Presets, see [Using System State Presets and the Preset Bar](#).

Using the Instrument Bar Options Menu

Further options to control the Instrument and Preset bars are available by right-clicking in the Instrument Bar to display the **Instrument Bar Options** menu, shown below:

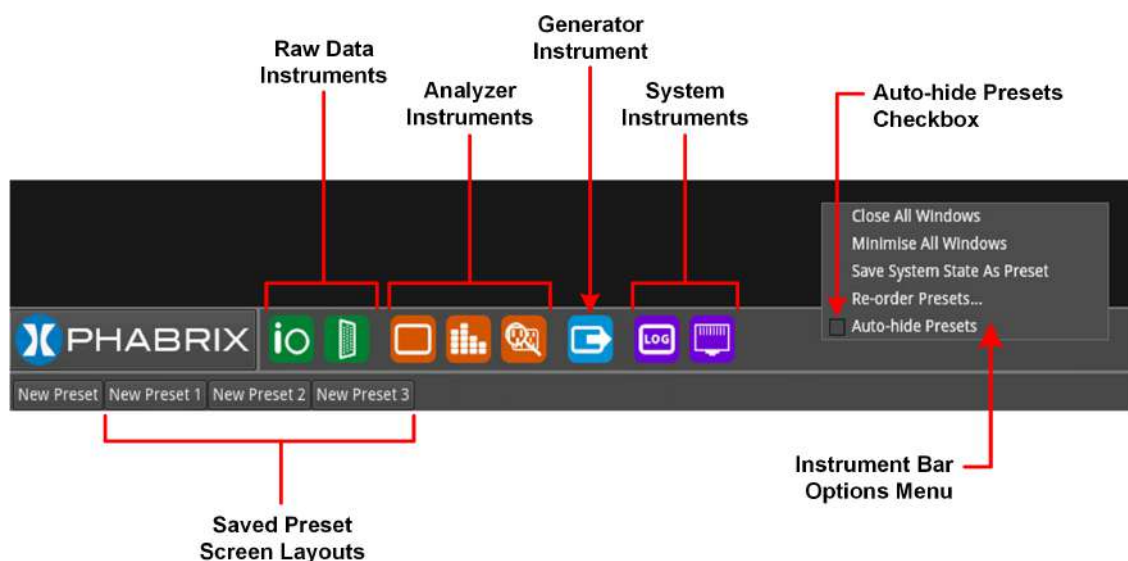

Figure 2-7: Instrument Bar Options Menu

You can close all Instrument windows together by right-clicking the Instrument Bar and selecting the option **Close All Windows** from the menu. In addition, you can also choose to minimize all open instruments to icons in the Instrument Bar by selecting the option **Minimize All Windows**.

When the **Auto-hide Presets** checkbox in the Options menu is selected, the Presets bar remains hidden when the Instrument Bar is active. To view any saved Presets, uncheck the **Auto-hide Presets** checkbox. For more information on saving system Presets, see the section [Using System State Presets and the Preset Bar](#).

Controlling the Audio Monitoring Source

An icon to control the Audio Monitoring Source is displayed at the right-hand side of the Instrument Bar, before the time and date display. The audio monitoring icon controls the audio monitoring output of the unit, whether monitoring over HDMI, SDI instrument monitor output, or 26-way D-type. Click once to mute or unmute the audio monitoring source.

The audio monitoring source icon changes to display the current status of the audio source as shown in the following table:

Table 2-1 : Audio Source Monitoring Icon States

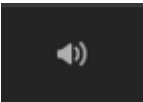
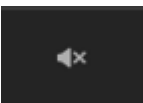
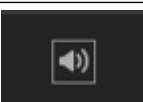
Audio Icon State	Description
	Standard state, audio source active (unmuted).
	Audio source muted (inactive).
	Audio source active (unmuted) with volume slider control displayed.

Hover over the audio icon to display a tooltip showing the current audio Source channel/pair selected.

To adjust the volume of the audio monitoring source, right-click the Audio icon to display a sliding volume control. Drag the slider left or right to adjust the volume of the audio monitoring source as required.

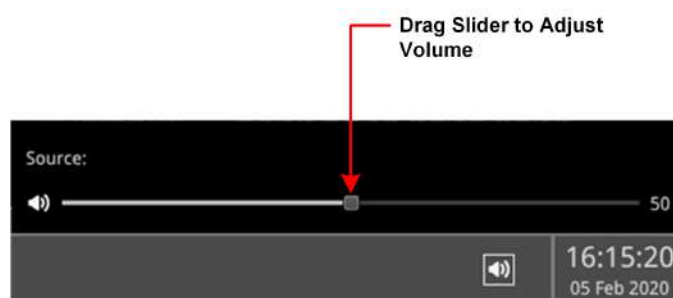

Figure 2-8: Adjusting the Volume of the Audio Monitoring Source

Use the **Analyzer - Audio Meters** Instrument to select the target audio monitoring source.

System Time and Date Display

The system date and time are displayed in the bottom-right corner of the screen.

To modify the system time and/or date, right-click in the time and date display. This displays a button with the following message:



Figure 2-9: Accessing the Time and Date Adjustment Dialog

Click the **Set Time & Date** button to open the Time and Date dialog. For more information on setting the system time and date, see the section: [Setting the Time and NTP Server](#).

Using System State Presets and the Preset Bar

Note: It is not possible to transfer System State Presets between QxL and Qx units as they will not be recognized.

Whenever you work with the QxL, you can save your current screen layout and settings as an Instrument **Preset** for ease-of-use and convenience. If you decide to start a different task, you can launch a Preset from the Preset Bar with a single click, rather than opening and adjusting individual Instruments.

You can save multiple Presets as required, giving you a library of bespoke layouts tailored to specific operational tasks. The unit saves each Preset to the **Preset Bar**, located below the Instrument Bar, and automatically labels each Preset sequentially as New Preset 1, New Preset 2, etc.

Once you have organized the display with your required Instruments, save as a Preset by right-clicking the Instrument Bar and selecting the option **Save System State As Preset** from the menu.

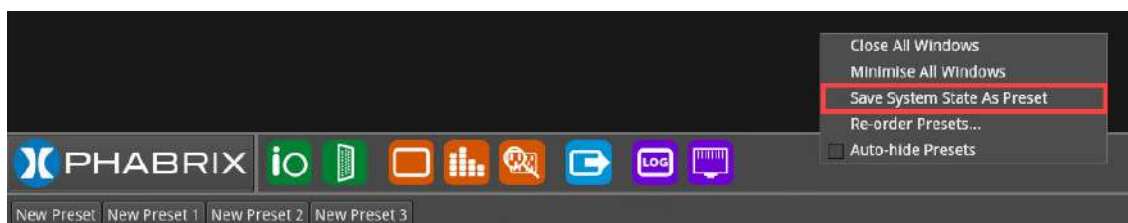

Figure 2-10: Save System State as Preset

A saved system state Preset saves the following items:

- Layout of currently active Instruments
- All user-defined settings in the active Instruments.
- All user-defined System settings, for example, Display Brightness.

On saving a Preset, the Preset Bar opens below the Instrument Bar, with the current screen layout saved with the default name **New Preset n**.

To save other layout Presets, organize the display as required, and repeat as above.

Reordering Presets

You can change the order in which your saved presets are saved in the Presets Bar. To do so, right-click in the Presets Bar and select the option **Re-order Presets...** to open the **Re-order Presets** dialog.

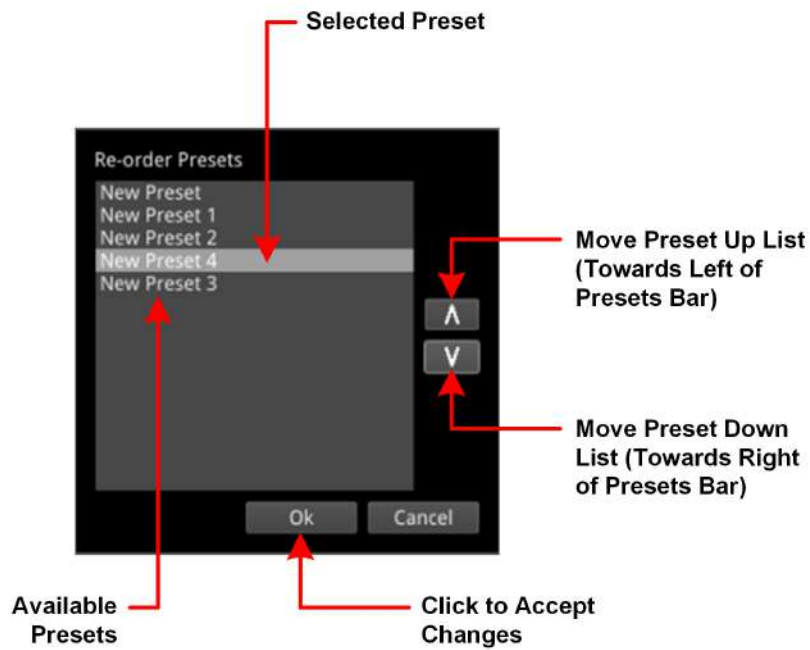

Figure 2-11: Reorder Presets Dialog

Select a preset, then use the Up and Down arrow keys to change the displayed position of the preset in the Presets Bar. Moving a preset up the list moves the preset towards the left of the presets Bar and down the list moves the preset to the right of the Presets Bar. Press **OK** to accept your changes and close the dialog.

Renaming Presets

Note: You will need to connect a USB keyboard to one of the USB ports of the unit before you can change the name of a preset. If a USB keyboard is not connected, the option **Rename Preset** is not available. An on-screen keyboard is not provided for this function in this software version.

To rename a Preset, connect a USB keyboard then right-click the preset name and select the option **Rename Preset**. The Preset Rename dialog is displayed, enabling you to rename the Preset using the connected USB keyboard.

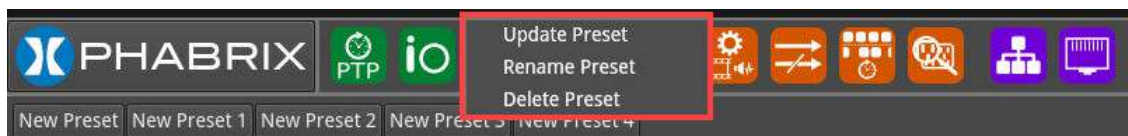

Figure 2-12: Preset Options Menu



Figure 2-13: Rename Preset Dialog

After entering a new name for the preset, select **OK** to save your changes.

Note: If you use the File Manager utility to upload presets from another unit, make sure that you reboot the unit after uploading the presets to ensure that the presets are registered on the new unit. Once the presets have been registered, you can rename them as previously described.

Other Preset Tasks

To delete a Preset, right-click the Preset, select the option **Delete Preset** and confirm the deletion. If you no longer wish to delete the preset, select Cancel.

To update an existing Preset with a changed screen layout, right-click the Preset, select the option **Update Preset** and confirm that you are happy to overwrite that preset. Your layout changes are saved to the same name and the previous settings are overwritten.

To hide the Preset bar automatically from view, right-click the Instrument Bar or Preset Bar and check the **Auto-hide Presets** checkbox. To display the Preset Bar, uncheck the checkbox.

Overview of the Instrument Windows

Each QxL Instrument window border and its corresponding icon is assigned a color and the icon and Instrument border are displayed in the assigned color to indicate that it is part of one of the following *groups* of Instruments:

- **System:** Instruments used to configure various elements of the QxL system. Default border color: white.
- **Analyzers:** Instruments used to analyze characteristics of the video signal and its associated components. Default border color: **orange**.
- **Generators:** Instruments used to generate a video or audio signal¹. Default border color: **cyan**.

The color-coding provides easy identification of the Instrument type. You can enable/disable the Instrument borders or modify the assigned color in the Display Options submenu, selected from the Instrument Launch Menu. For more information on setting-up the display, see the section: [Setting-up the Display](#).

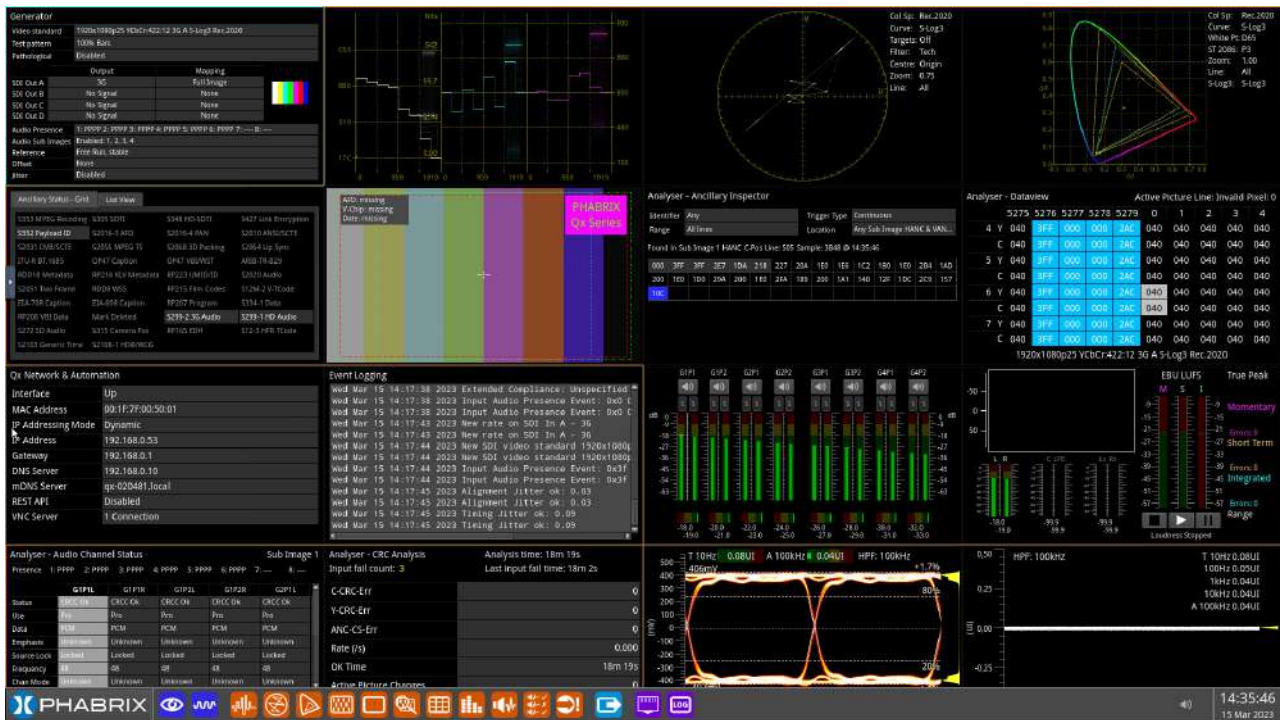

Figure 2-14: Full Screen with Active Instruments

Changing the Border Color of Instrument Windows

If desired, you can change the border color of Analyzer and Generator Instruments as described in the Section: [Setting-up the Display](#).

Note: The borders and icons of System Instruments are always colored white.

Instrument borders automatically merge by group color. If you position one Analyzer instrument, for example, next to another Analyzer, then the border will outline all instruments in the common group, in contact with each other, to aid group recognition.

¹Software option

In addition, signal connectors displayed in instrument windows (for example, in the System IO instrument) are displayed in the Analyzer color to indicate an input or the Generator color to indicate an output, when they are active.

Working with the QxL Instruments

Each QxL Instrument includes a pop-up options menu, displayed by right-clicking the mouse in the window, which gives you access to the configuration parameters of that instrument.

Once open, you can move the menu to any position on the screen by clicking the gray bar at the top of the menu and dragging it to a new position.

In addition to listing the Instrument-specific parameters, or providing access to further configuration dialogs, the options menus include the following operational commands:

- **Take Screenshot:** Saves an image of the current active display to the unit's SSD storage.
- **Dismiss Menu:** Closes the options menu.
- **Minimize "Instrument":** Minimizes the selected Instrument to an icon in the Instrument Bar, removing it from the display. You can click the minimized icon to restore the Instrument to its original location, at its original size and containing the actual content.
- **Close "Instrument":** Closes the Instrument, removing it from the display and Instrument Bar.

The following figure shows an example of a popup options menu displayed by right-clicking in the **Generator** Instrument:

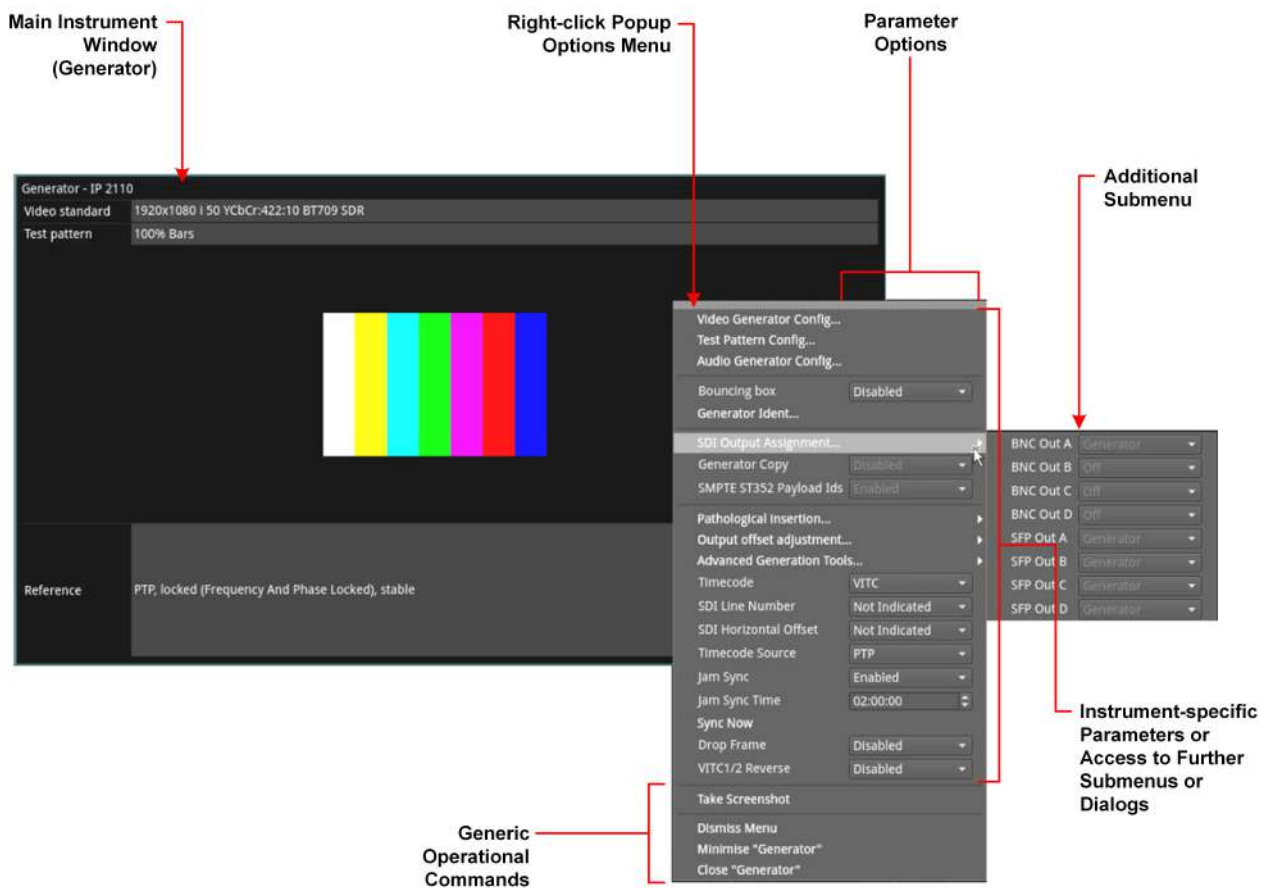

Figure 2-15: Instrument Popup Options Menu Displayed

Other generic dialog windows (About, False Color Ranges, Driver Calibration, etc.) also include right-click menus with options to take a screenshot, dismiss the menu, and close the dialog window.

Selecting Submenu Options and Entering Values

You can select most options in the instrument menus by selecting a parameter from a dropdown listbox. For example, you might enable or disable a parameter by selecting **Enable** or **Disable** from a dropdown list.

Other parameters require you to enter a numeric value, for example, the number of Eyes displayed in the **Eye - SDI In A** Instrument, or the Brightness in the **Analyzer - Vectorscope** Instrument.

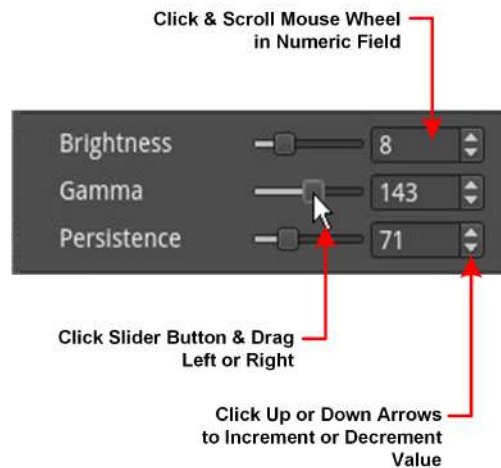



Figure 2-16: Adjusting Numeric Values in the Analyzer - Vectorscope Instrument

You can adjust a numeric value using one of the following methods:

- Click the slider button and drag left or right to decrease or increase the value, respectively.
- Click the cursor in the numeric field and scroll the mouse wheel backward or forward to decrease or increase the value, respectively.
- Enable the onscreen keyboard in the **Display Options** of the Launch menu (default setting), click  corresponding to the field to be changed and enter the new value using the displayed keypad then click OK to save the address.
- Disable the on-screen keyboard in the **Display Options** of the Launch menu, connect a USB keyboard to the unit, click in the numeric field and enter the new value using the keyboard.

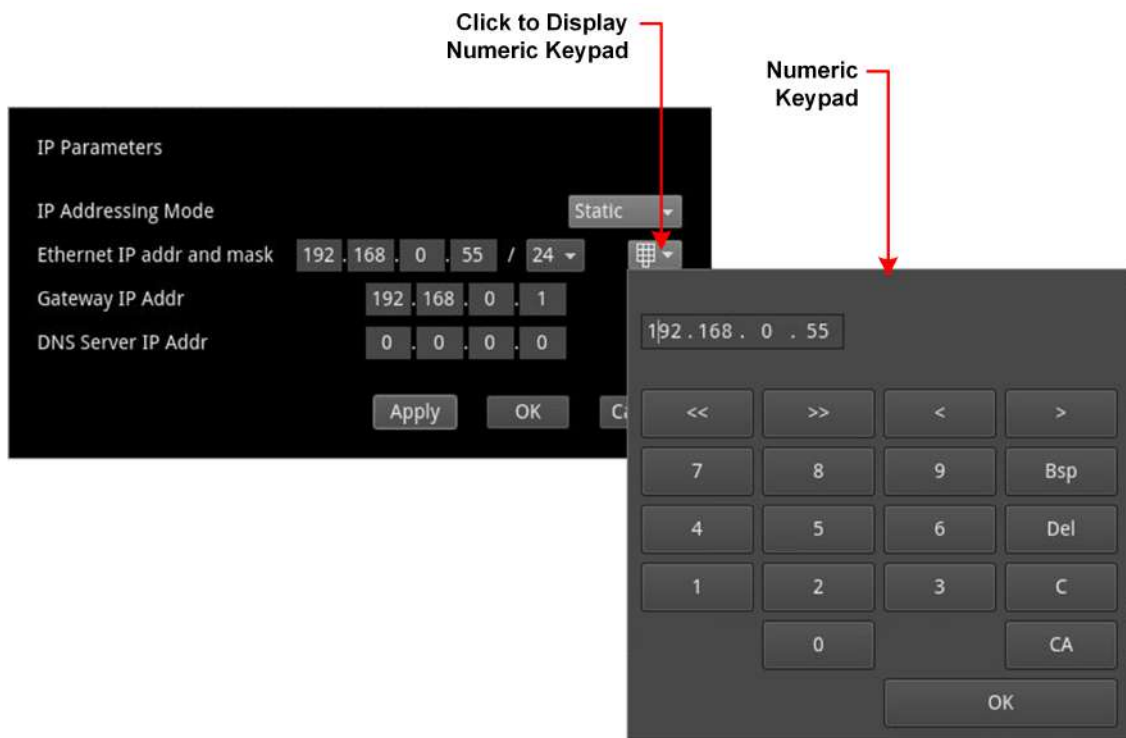

Figure 2-17: Manual Entry of a Static IP Address in the Qx Network & Automation Instrument

Resizing an Instrument Window

Double-click in any Instrument window to cycle through a set of standard instrument window sizes - 1/16, 1/4 or, in some cases, full screen size.

For some instruments, you can manually drag the window to one of the standard sizes. To do so, hover the cursor over either the bottom right-hand corner until a double-headed arrow is displayed, then drag the border until the Instrument reaches the desired standard size.

Note: When an instrument window is set to full-screen size, it is not possible to overlay another instrument window on top of the full-screen window.

Using the Instrument Scroll Bars and Scroll Control Menu

For those Instruments displaying a large amount of data, vertical and horizontal scroll bars are provided to help navigate through the data. A scroll control menu, accessed by right-clicking the scroll bar provides further scrolling or paging options.

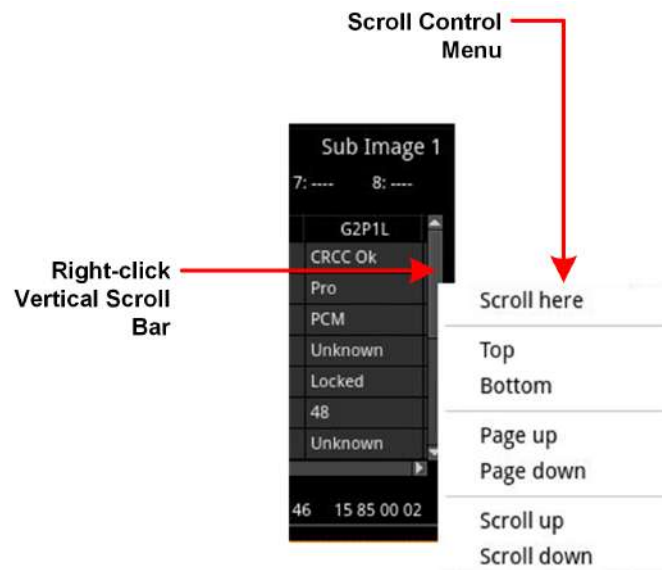

Figure 2-18: Instrument Scroll Bar Control Menu

Using the Window Panel Slider Controls

In Instruments with two active panels, for example, the NMOS single interface Receiver/Sender SDP and ISO5 windows, a vertical slider enables you to change the size of either panel for improved viewing. Simply move the slider up or down to adjust the viewable area of either panel.



Figure 2-19: Window Panel Slider Controls

Taking Screenshots

Note: Before taking a screenshot, first disable VNC in the submenu of the **Network & Automation** Instrument and set the display brightness to its maximum setting using the **Display Options** in the Launch menu.

To capture an image of the entire display, open an Instrument submenu and simply select **Take Screenshot**. The image is saved to the SSD as a portable network graphic (.PNG) format file. Alternatively, connect a USB keyboard to the unit and press **[Shift] + [PrtScn]** to capture the display. You can retrieve your saved screenshots, in PNG format, from the SSD using the USB File Manager or a remote connection method, as required. For more information on retrieving the file from the unit, see the section [Connecting to the Unit Using a Web Browser](#).

Working with Instrument Tabs

Some QxL instruments feature tabs along the top of the window which provide quick and easy access to different functional areas or views within a single Instrument.

The following figure shows the **Analyzer - Ancillary Status** instrument, which includes a tab to display data in a grid format and a separate tab to display data in a list.

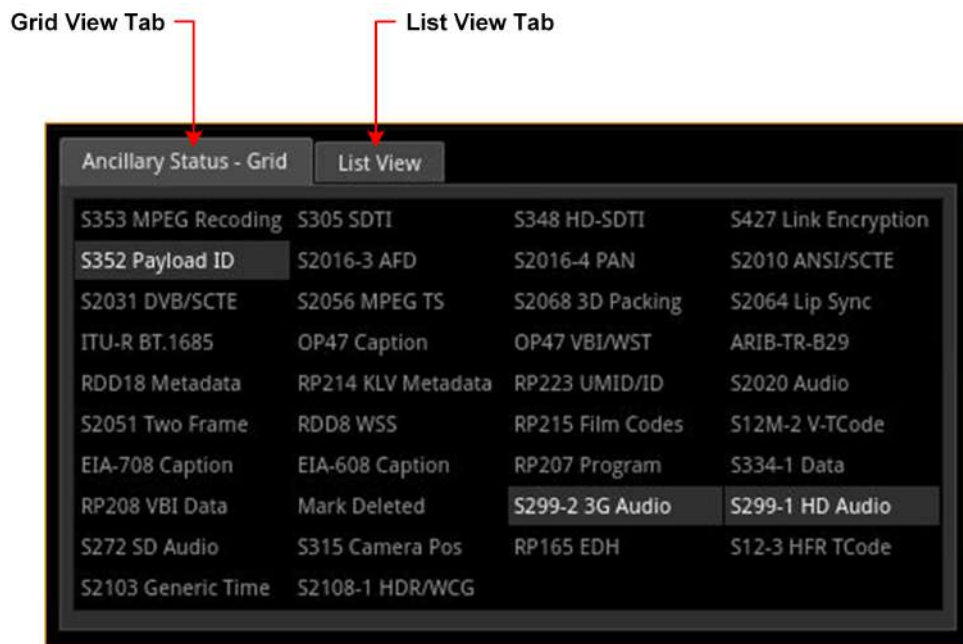

Figure 2-20: Example of Tabs in the Analyzer - Ancillary Status Instrument

The unit also uses tabs to present alternative configuration dialogs. For example, the Multicast/Flow Config dialog of the **IP Receive - Flows** instrument provides tabs that enable you to switch between selecting either multicast requests, flow configuration or NMOS flow configuration.

Using Instrument Dialogs

The following instruments provide access to additional configuration dialogs from the options menu, which enable you to select associated parameters quickly and efficiently:

- Qx Network & Automation
- SFP IP Network
- SFP E/F - PTP Info
- Analyzer - 2110 Format Setup
- IP Receive - Flows
- NMOS Configuration
- Generator (Video and Audio Configuration)
- Analyzer - Video Standard

The **Video Override Parameters...** configuration dialog for the **Analyzer - 2110 Format Setup** instrument is shown in [Figure 2-21](#).

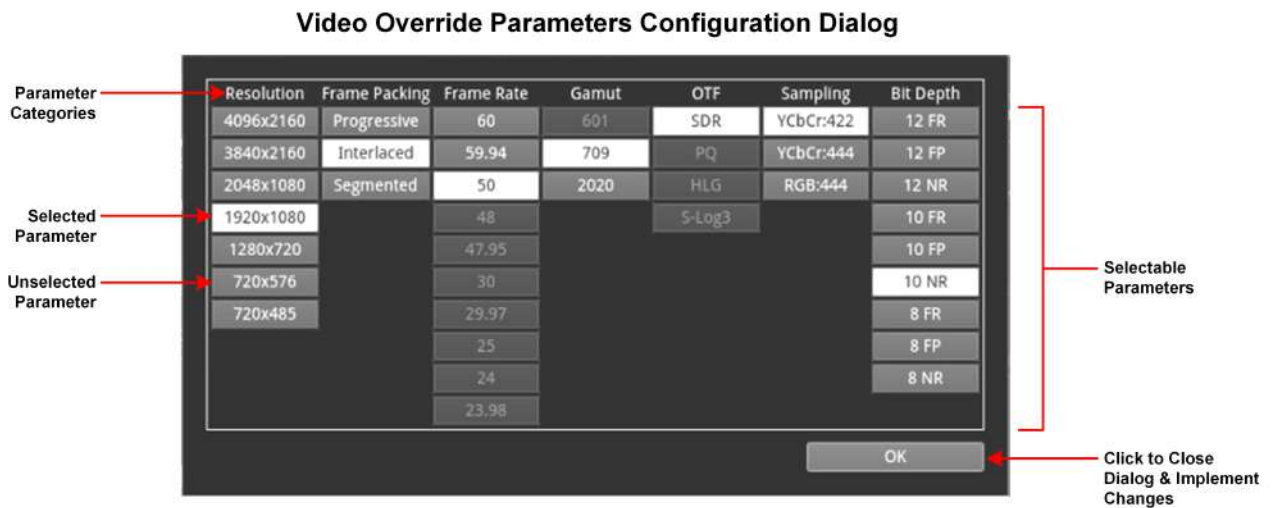

Figure 2-21: Configuration Dialog for Manual Override of ST 2110 Input Video Parameters

When you open a configuration dialog from an instrument's options menu, select the required parameters from the available controls, then click **OK** to save and implement your changes and quit the dialog.

Any invalid parameters in a dialog are grayed-out.

Using the Color Picker

Several of the Qx instruments enable you to select a color from a Color Picker as a configurable display attribute. For example, you can specify the color of the Analyzer and Generator instrument borders, choose a text highlight color in the NMOS SDP instruments, or choose colors in a custom false color overlay in the Picture instrument, among others.

Select a color as follows:

1. Select the dropdown color selector to open the Color Picker tool (also referred to as the Hue, Saturation, Value (HSV) tool) shown below.

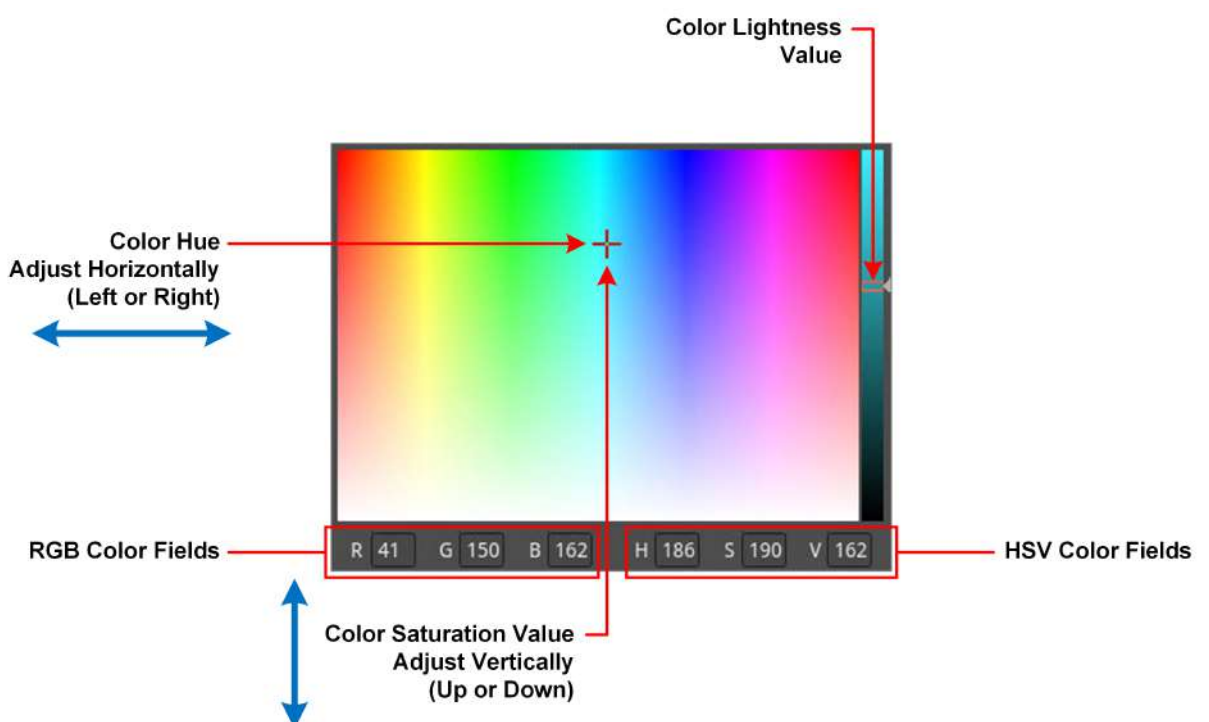

Figure 2-22: Selecting Colors in the Color Picker

2. Enter the RGB or HSV values, if know, into the appropriate color fields along the bottom of the window. Alternatively, pick a color manually as follows:
 - a. Click at a point in the left-hand color panel of the Color Picker to select the hue (horizontal) and saturation (vertical) settings of the new color choice.
 - b. Click at a point in the right-hand vertical bar to select the color lightness value.
3. Close the HSV menu.

Instrument Icon Quick Reference

The icons shown below each represent a different Instrument (some optional) and are displayed in the Instrument Bar when the corresponding Instrument is active.

System Instruments:



Event Logging



SFP IP Network



Qx Network & Automation



Analyzer - LLDP Data

Video Standard Analyzer Instruments:



Analyzer - CIE Chart



Analyzer - Data View



Analyzer - Vectorscope



Analyzer - Video Standard (SDI & 2022-6)



Analyzer - Ancillary Status



Analyzer - Audio Meters



Analyzer - 2022-7 Status



Analyzer - Loudness Monitor



Analyzer - CRC Analysis



Analyzer - Picture /
Analyzer - Picture Copy



Analyzer - Waveform



Analyzer - Ancillary Inspector



Analyzer - Audio Channel Status



Analyzer - 2110 Format Set



Analyzer - 2110-21 Status



Analyzer - Dolby Metadata

Physical Analyzer Instruments:



Eye - SDI in A



PRBS Analysis



Jitter SDI in A

Generator Instruments:



Generator



2022-6 Transmit (SFP F)
2110 Transmit (SFP E/F or E+F)

Raw Data Instruments:



SFP E - Network Stats



AES IO Config



SFP E - Info



SFP E / F - PTP Info



SFP F - Network Stats



System IO



SFP F - Info

Datastream Analyzer Instruments:



Stats - SDI in A



Stats - SDI in C



Video Timing & System Reference



IP Receive - Interpacket Timing



NMOS Status and Configuration



NMOS Receivers - SDP



NMOS Sender - SDP



Stats - SDI in B



Stats - SDI in D



IP Receive - Flows



Stats - 2022-6 Receive



NMOS Receivers - IS05



NMOS Sender - IS05

Configuring and Checking the Unit

This chapter describes how to set-up some fundamental parameters and check that the unit is working correctly; it includes the following sections:

- [Qx Network and Automation](#)
- [Setting the Time and NTP Server](#)
- [Setting-up the Display](#)
- [Checking the Unit](#)
 - [Checking the System Health Status](#)
 - [Checking the Licenses](#)
 - [Restarting the Unit](#)
 - [Restoring Factory Default Settings](#)
- [Switching Between Analyzer Inputs](#)
- [Resetting the SFP Configuration Database](#)
- [Upgrading the Software, Firmware and Options](#)
- [Managing Files with the USB File Manager](#)
- [Packet Capture \(PCAP\)](#)
- [Event Logging on the Unit](#)
- [Remote Connection to the Unit](#)



Overview

The **Qx Network & Automation** instrument provides all the control network information and facilities you need to connect the unit to a network and then connect remotely to control its interface.

Once the unit is powered on and an RJ45 Ethernet connector inserted in the management port, you can access the unit remotely and set its date and time from an NTP server. You can choose either dynamic or static IP addressing for the management Ethernet port.

You can control the unit from a remote location using a number of methods, including:

- Virtual Network Computing (VNC)
- REST API (for automated testing).

Qx Network & Automation	
Interface	Up
MAC Address	00:1F:7F:00:56:D4
IP Addressing Mode	Dynamic
IP Address	192.168.1.19
Gateway	192.168.0.1
Default Gateway	192.168.0.1
DNS Server	192.168.0.10
mDNS Server	qx-022228.local
REST API	Listening on port 8080
VNC Server	1 Connection

Figure 3-1: Qx Network & Automation Instrument

Using Virtual Network Computing (noVNC or VNC) for Remote Access

The virtual network computing or VNC facility enables you to connect to the unit from a remote location and provides you with direct screen control of the unit.

When you enable the **VNC Server** parameter in the options menu, the unit allows remote access to its noVNC client, from a standard web browser, across a dedicated network socket. In addition, you can also connect remotely using a suitable, locally-installed VNC client viewer (for example, VNC® Connect, etc.)

For more information on establishing a remote connection using noVNC or from a VNC client to the unit, see the section [Using Virtual Network Computing \(VNC\)](#).

Instrument Menu Options

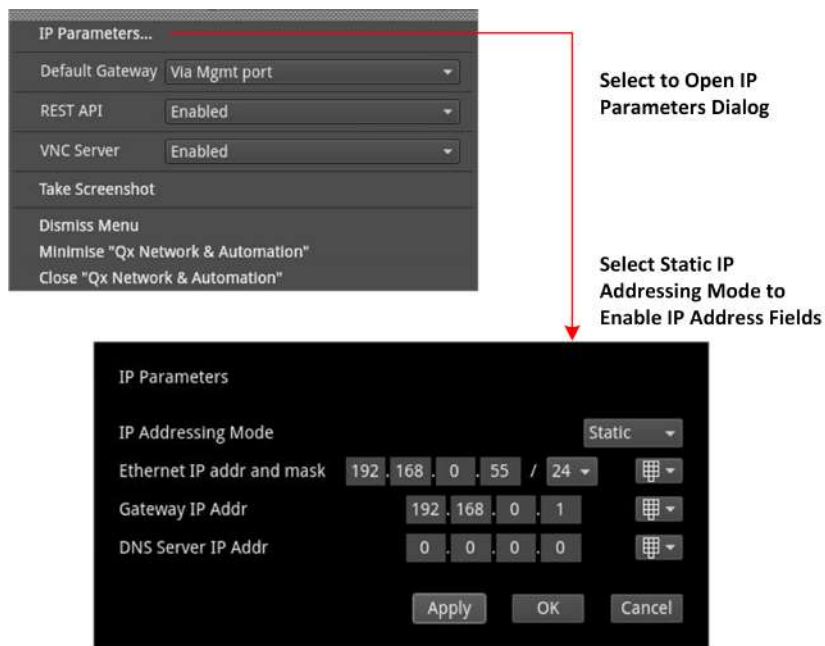

Figure 3-2: Qx Network & Automation Instrument Menu Options

The following table lists the configurable parameters in the Qx Network & Automation instrument options menu:

Table 3-1 : Qx Network & Automation Menu Options

Item	Options	Description
IP Parameters		
IP Parameters...	System Control	Open IP Parameters dialog.
IP Addressing mode	Dynamic Static	For remote access to the unit, you can assign the IP address of the unit either dynamically, on a DHCP enabled network, or specify a static IP address manually. When assigned dynamically using DHCP, the following IP address fields are automatically populated and cannot be edited.
Ethernet IP addr and mask	Enter static IP address and mask (range: 8 to 31) as required.	Only active when static IP addressing is selected. Use the dropdown list to select the Mask. The unit uses CIDR notation; with a default value of / 24 . Use either a USB keyboard or click the keypad icon to enter the address using the numeric keypad.

Item	Options	Description
Gateway IP Addr	Enter the IP address of the Gateway as required.	Only active when static IP addressing is selected. Use either a USB keyboard or click the keypad icon to enter the address using the numeric keypad.
DNS Server IP Addr	Enter the IP address of the DNS Server.	Only active when static IP addressing is selected. Use either a USB keyboard or click the keypad icon to enter the address using the numeric keypad. After entering all required static IP parameters, click Apply IP Parameters .
Default Gateway		
Default Gateway	Via Mgmt Port (Default) Via SFP E Via SFP F	Select the preferred network interface for network traffic. This can either be the default management port as assigned by the operating system or either SFP E or SFP F.
Remote Connection Parameters		
REST API	Enabled Disabled (Default)	When enabled allows remote connection to the unit using the REST API. The Qx Network & Automation window contains all the information on the unit required to submit a REST request. It is recommended to use the IP Address (or mDNS Hostname if your client's host supports it) as the recipient of the request, and the REST API Port is the port towards which requests need to be directed. The REST API supports four HTTP methods: GET, PUT, DELETE, and POST. Use GET requests to retrieve information and navigate the submenus and PUT requests to modify and control the unit's behavior and actions. Use a web browser to retrieve information from the unit using GET requests. You can use any HTTP/1.1 compliant application to control the unit using GET and PUT requests. In addition, PUT, GET, DELETE, and POST requests can be scripted for automated testing.
VNC Server	Enabled Disabled (Default)	When enabled allows remote connection to the unit from either: <ul style="list-style-type: none"> • A standard web browser using noVNC to connect to the noVNC client on the unit by way of a dedicated network socket, or • A locally installed VNC client viewer (for example, VNC® Connect). The VNC Server field of the Network & Automation window shows the number of current VNC connections to the unit. Once a connection is made, or ended, this number is automatically updated. For more information on using VNC to connect remotely to the unit, see the section Using Virtual Network Computing (VNC)

Note: The mDNS Hostname has the following case-sensitive syntax:

qx-*<serial number>*.local. For example: **qx-123456.local**

Using the Numeric Keypad to Enter Static IP Details

If you select a static IP addressing mode in the IP Parameters dialog, click the keypad icon  to display the numeric keypad as shown in [Figure 3-3](#).

Enter an address using the keypad as follows:

1. Use the backspace to remove digits to be replaced or highlight a segment to overwrite.
As you enter digits, the unit automatically validates the content of the segment.
2. Enter the new address using the number keys as required.
3. Click **OK** to save the new address to the address fields and close the numeric keypad.
4. If you need to change the subnet mask, select the appropriate value from the dropdown box.
5. When satisfied with all IP addressing parameters, click **OK** to save and exit the dialog.

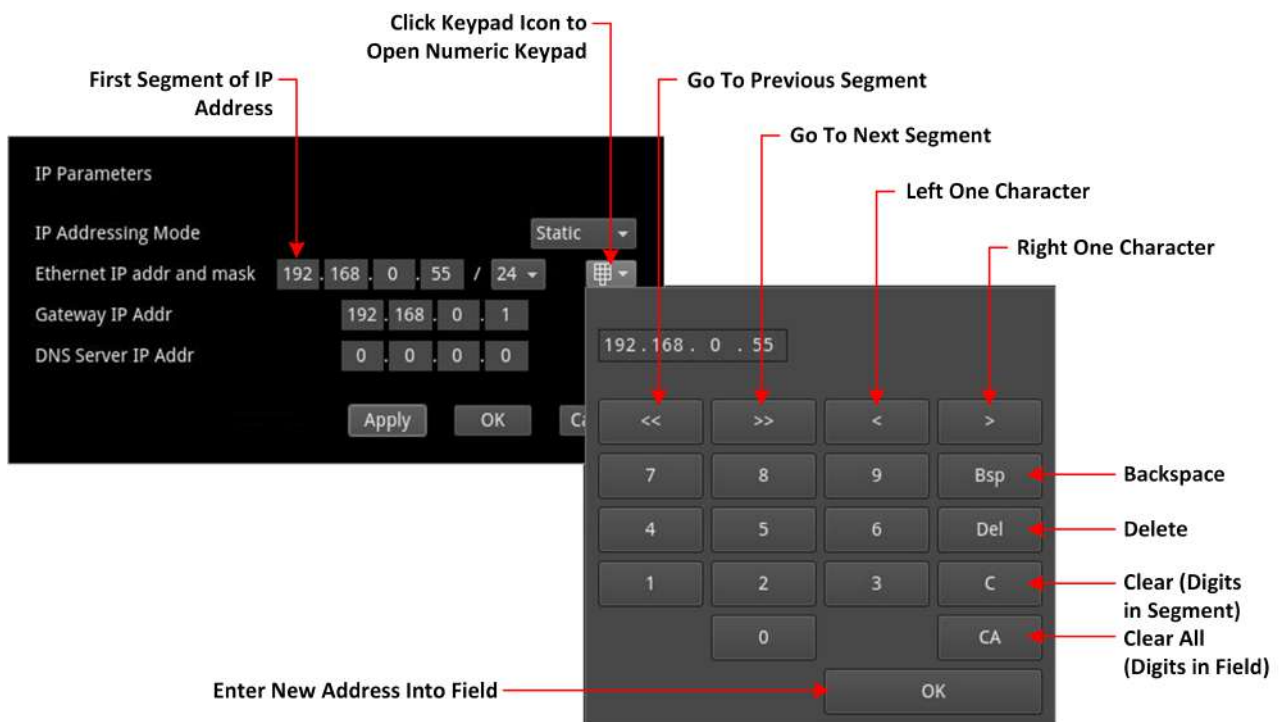

Figure 3-3: Numeric Keypad to Enter Static IP Addresses

Setting the Time, Date and NTP Server

The unit displays the system date and time in the bottom-right corner of the screen.

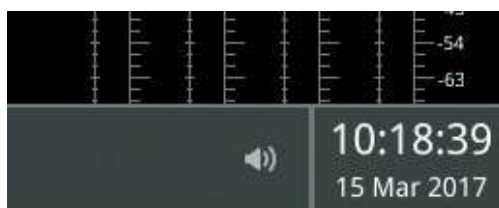

Figure 3-4: Date and Time Display

You can configure the unit to use a date and time transmitted by a target Network Time Protocol (NTP) server or set the time and date manually in the Time and Date dialog.

Configure the date and time as follows:

1. Right-click on the time/date display in the bottom-right corner of the screen.
2. Select: **Set Time & Date**.
This opens the Time and Date dialog.

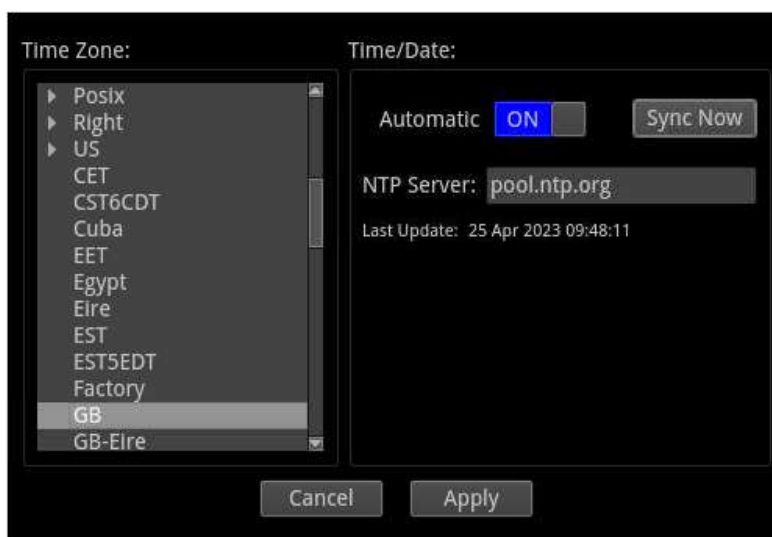

Figure 3-5: Time and Date Dialog

3. To use the automatic time and date from an NTP server:
 - a. Set the **Automatic** toggle switch to **ON**.
 - b. Enter the address of the NTP Server using the onscreen keyboard or a USB keyboard connected to the unit.
For example: **pool.ntp.org**
 - c. Select your local time zone from the **Time Zone** list box.
 - d. Click **Sync Now** to synchronize to the selected time zone.
 - e. Click **Apply** to save your changes and quit the dialog.
To discard your changes, click **Cancel**
4. To set a time and date for the unit manually:
 - a. Set the **Automatic** toggle switch to **OFF**.
This displays the manual date and time fields.

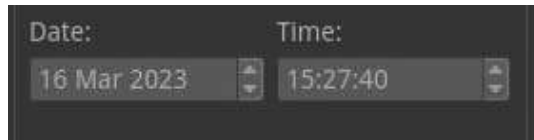





Figure 3-6: Manual Date and Time Fields

- b. Adjust the date and time by clicking the target item and either increase or decrease the setting using the mouse scroll wheel or the up/down arrow buttons at the right of the fields. You can also enter a date or time using the onscreen keyboard (if enabled) or a USB keyboard connected to the unit.
- c. Click **Apply** to save your changes and quit the dialog.
To discard your changes, click **Cancel**

Table 3-2 : NTP Traffic Generation

Automatic Toggle Switch Setting	Action	Result
	None	Unit stops synchronizing with NTP servers. No NTP traffic generated.
	Click Sync Now	Force one-time synchronization with NTP server. Note: Generates NTP traffic for the single sync and then no longer.
	Click Apply	Unit automatically synchronizes with the NTP server and continues to do so, generating NTP traffic. Closes Time Setting dialog. Unit displays UTC time according to the selected timezone.

Setting-up the Display

Modifying the Display Options

The unit's Display options enable you to set the display brightness and output frame rate, or modify the appearance of the Instrument windows on the screen. In addition, you can set the units for the display of temperature measurements.

Configure the display to which the unit is connected as follows:

1. Click the PHABRIX button to open the Instrument Launch menu.
2. Select: **Display Options**.
This opens a submenu listing the configurable display options.

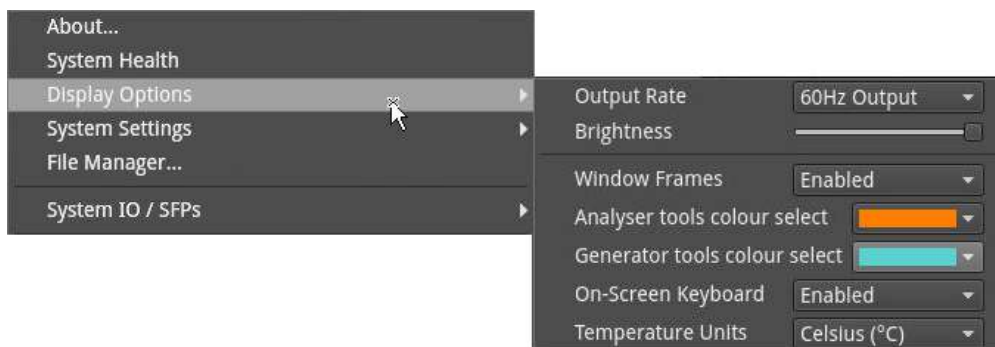

Figure 3-7: Display Options in the Instrument Launch Menu

3. Select the desired frame rate from the **Output Rate** dropdown list:
 - 50 Hz
 - 59.94 Hz
 - 60 Hz
4. Drag the **Brightness** slider left or right to decrease or increase the display brightness to a comfortable level.

Note: When using the Screenshot function to capture the display, it is recommended to set the brightness to the maximum setting to increase the clarity of the saved image.

5. Choose whether to display a border around the Instruments by enabling or disabling the option **Window Frames**.
When disabled, you switch off the border color differentiation between Analyzer and Generator Instruments.
6. When the option **Window Frames** is **Enabled**, you can change the border color of Analyzer or Generator instruments as described in the section [Using the Color Picker](#).

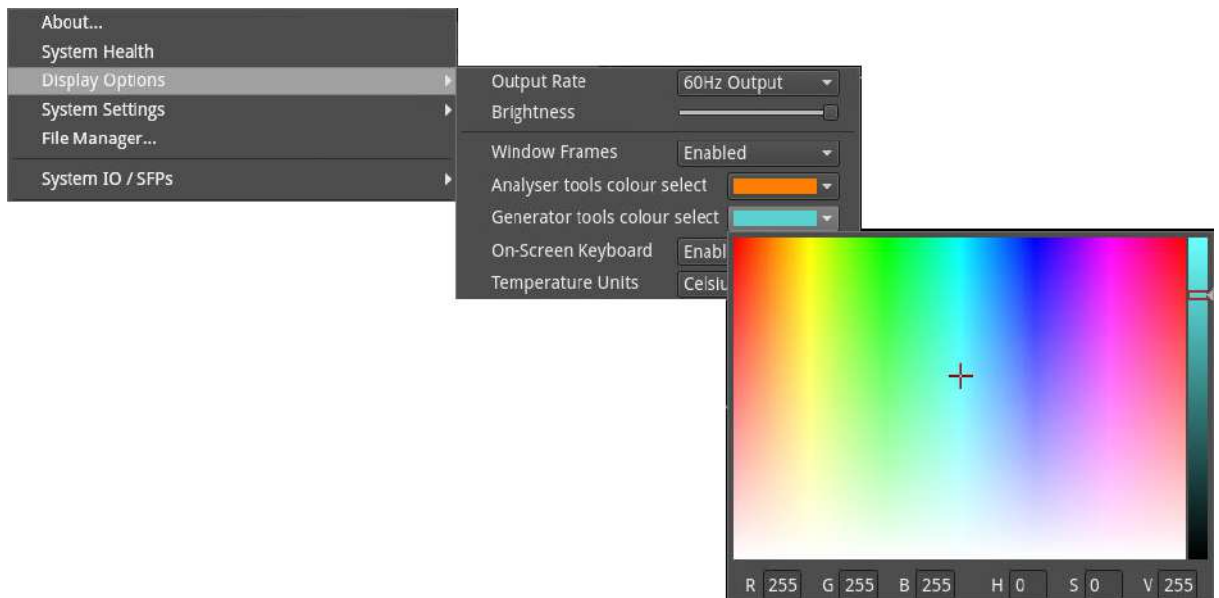

Figure 3-8: Selecting Analyzer and Generator Border Colors in the HSV Window

Note: The borders and icons of System Instruments are always colored white.

7. Choose whether to use the **Onscreen Keyboard** for text and numeric entry in instrument dialog fields. The onscreen keyboard is enabled by default. If you choose to disable the onscreen keyboard you will need to have a USB keyboard connected to one of the USB ports on the unit. Alternatively, you can also use the keyboard connected to a PC from which you have initiated a remote connection to a unit using noVNC.
8. Choose whether to display system temperature measurements in units of degrees Celsius (°C) or Fahrenheit (°F) from the **Temperature Units** dropdown. The selected units are used in all instruments where a temperature measurement is displayed.
9. Click anywhere outside the menus to quit and save your new display settings.

Checking the Unit

Overview

Your QxL unit should now be powered on, with the correct date and time showing, and at least the basic screen displayed, including any of your modifications. At this point you should confirm that the unit is healthy and running correctly, as expected, by checking the following:

- System Health
- Licensing and ordered licensed options
- Software and firmware versions.

These items are described in the following sections.

Checking the System Health Status

You can check the current health status of the unit in the **System Health** dialog as follows:

1. Click the PHABRIX button to open the Instrument Launch menu.
2. Select: **System Health**.
This opens the System Health dialog displaying the current health of the unit's hardware, including: CPU and FPGA temperature in degrees Celsius or Fahrenheit, voltage (DDR and 5.5 V), and cooling fan revolutions.

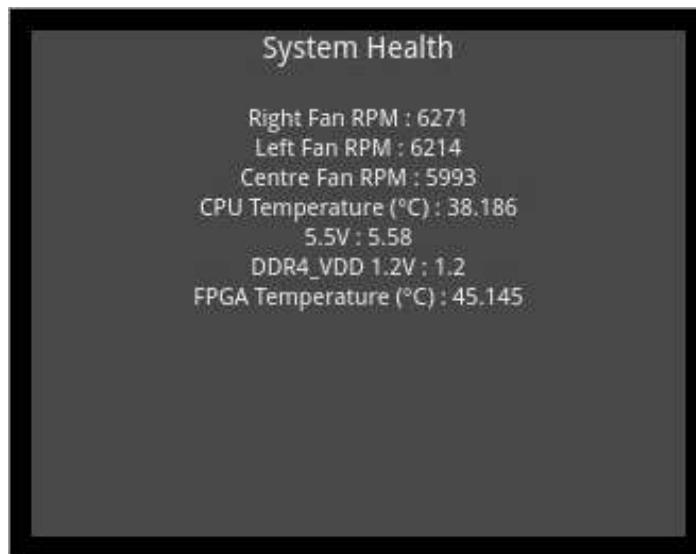

Figure 3-9: System Health Information

Table 3-3 : System Health Recommended Thresholds

Item	Safe Range	Description
CPU Temperature	From 0° to 85°C (32° to 185°F)	Unit will issue a high temperature warning at 80°C (176°F) and switch off at 85°C (185°F)
FPGA Temperature	From 0° to 85°C (32° to 185°F)	Unit will issue a high temperature warning at 80°C (176°F) and switch off at 85°C (185°F)
5.5 V	5.030 to 5.734 V	Hardware switches off the unit if the voltage moves

Item	Safe Range	Description
		outside the safe range.
DDR Voltage	1.283 to 1.580 V	Hardware switches off the unit if the voltage moves outside the safe range.
Cooling Fans	3000 to 9500 rpm	Speed of fans varies with the temperature of the unit. Three cooling fans are located in the front of the unit - in left (L), center (C) and right (R) positions.

Checking the Unit Licenses

It is important at this point to confirm that your unit has been shipped with the software options and corresponding licenses documented in your original order.

Check the licensing details and other system information in the **About** dialog as follows:

1. Click the PHABRIX button to open the Instrument Launch menu.
2. Select: **About**.

This opens the About dialog listing detailed information about the system, including:

- Software version and build
- Unit serial number
- License details
- Build ID
- Mezzanine ID (Optional)
- FPGA details
- Calibration details
- QT OS version.



Figure 3-10: Serial Number and License Information

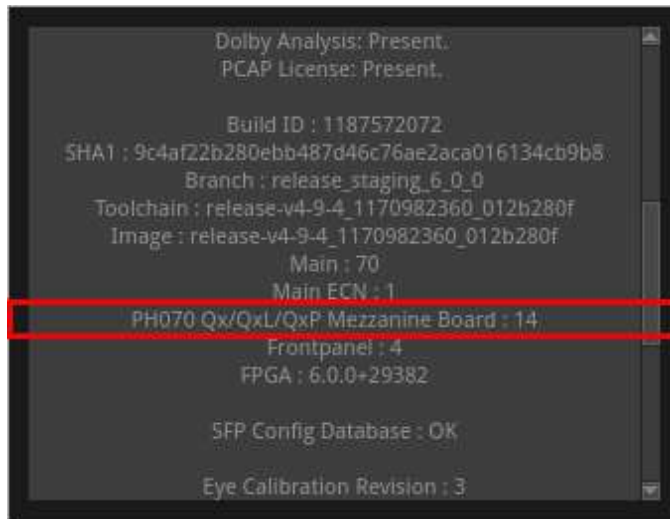

Figure 3-11: Mezzanine ID in About Dialog (Optional)

Restarting the Unit

If at any time you want to restart the unit, you can do so from the **System Settings** options, accessed from the Instrument Launch menu, without powering-down the unit.

Restart the unit as follows:

1. Click the PHABRIX button to open the Instrument Launch menu.
2. Select: **System Settings**.



Figure 3-12: System Settings Option Menu

3. Select: **Restart Qx**.
 This opens a Restart confirmation dialog.

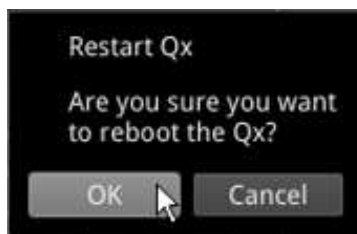

Figure 3-13: Display Options in Instrument Launch Menu

4. Click: **OK** to confirm the restart or **Cancel** to quit without restarting.
 When you confirm the restart, the unit immediately enters boot mode and displays its status using the LED behind the On switch.

Restoring Factory Default Settings

If you make configuration changes to the unit which you would rather discard, you can restore the unit to the factory default settings at any time.

Restore the factory defaults as follows:

1. Click the PHABRIX button to open the Instrument Launch menu.
2. Select: **Restore Default Settings**.
This opens a confirmation dialog, shown below, where you are prompted to confirm your choice before the factory defaults are restored.

Note: It is recommended first to copy all your saved Presets to a USB memory stick as a backup, using the File Manager, before restoring the factory defaults.

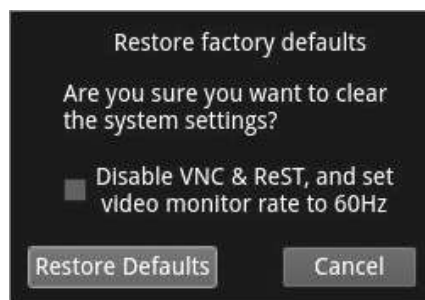

Figure 3-14: Confirmation to Restore Factory Default Settings

3. If you want to restore VNC, ReST and video monitor rates to factory defaults (disabled, disabled and 60 Hz respectively) select the checkbox. Otherwise, leave the checkbox unchecked.
4. Click: **Restore Defaults** to confirm or **Cancel** to quit.

Alternatively, make sure that *no* USB memory sticks are inserted in any of the USB ports, then press the power button *twice* in quick succession. The power button changes color to magenta and the unit restarts with the factory default settings restored.

Switching Between Analyzer Inputs

The unit's firmware enables you to switch the input to the Analyzer between the following:

- IP Input, supporting:
 - SMPTE ST 2022-6
 - SMPTE ST 2110 decapsulation (reception) of video (2110-20), audio (2110-30/2110-31), ancillary (ANC) (2110-40) flows.
 - SMPTE ST 2022-7 SIPS and dual ST 2059 (PTP).
- SDI Input, supporting:
 - Up to 12G SDI (Factory fitted option, including SDI Stress Tools)

All instruments are available for selection, however, if an instrument is not intended for use with a particular input (IP or SDI) then an appropriate warning is displayed.

Depending on your product license(s), you can switch inputs to the Analyzer using any of the following methods:

From the Launch Menu:

1. Click the PHABRIX button to open the Instrument Launch menu.
2. Select: **System Settings** to open the following submenu :



Figure 3-15: Switching Between Boot Modes

3. Depending on the currently selected analyzer input, select either:
 - Switch Analyzer Input To SDI (Factory fitted option)
 - Switch Analyzer Input To IP

Note: If your unit does not include the factory-fitted SDI hardware option, the **Switch Analyzer Input** option is not available in the System Settings submenu as it is not possible to switch to SDI input for an IP-only unit.

The input changes automatically without requiring a reboot and the following message is displayed:

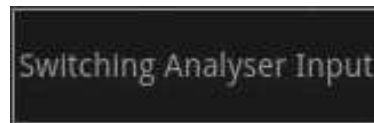

Figure 3-16: Switching Analyzer Input Message

From the System IO Instrument:

1. Open the **System IO** instrument:

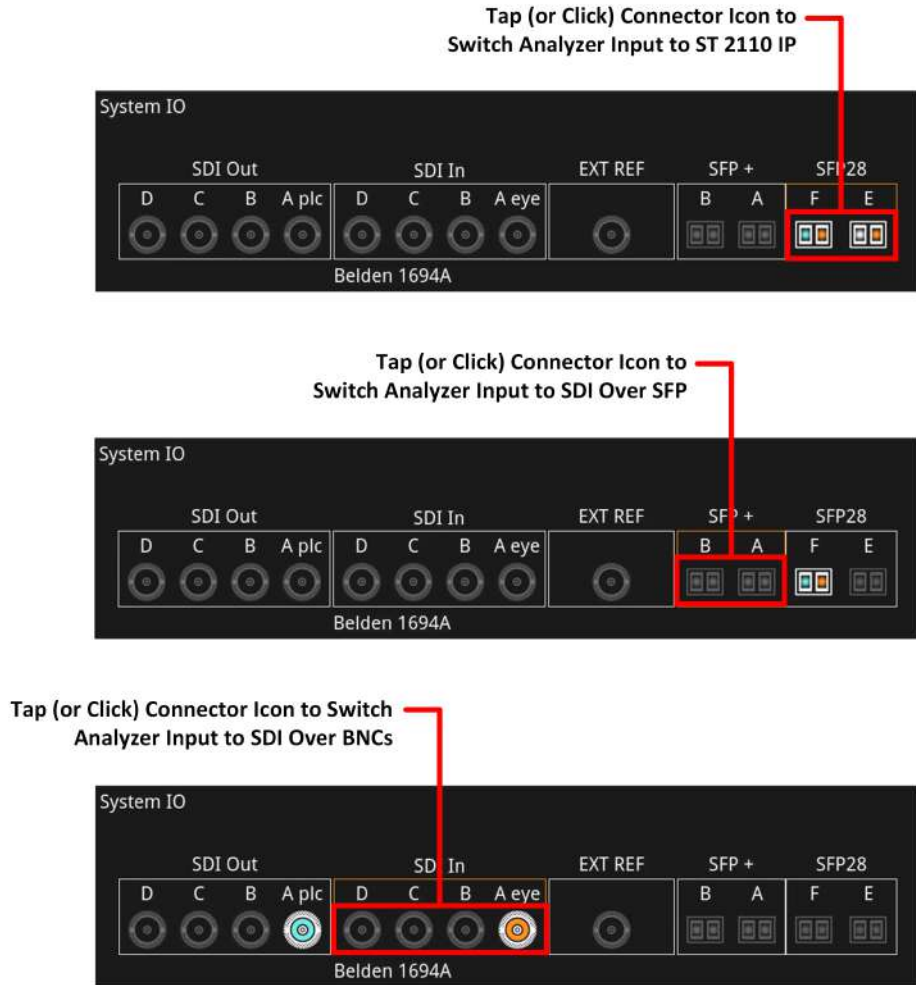
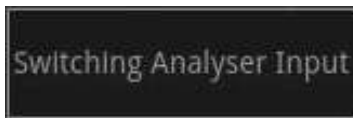

Figure 3-17: Confirmation Dialog to Switch Analyzer Input ¹

2. Tap or click the icons representing the type of connector for the desired input to the Analyzer.

The input changes automatically without requiring a reboot and the following message is displayed:



You will see that the border surrounding the selected connector block changes to orange to show the active Analyzer input.

Resetting the SFP Configuration Database

By default, the unit's SFP Configuration Database contains configuration details for the approved, factory supplied SFPs.

¹Note: SDI is a factory-fitted option

Note: If you have previously modified the SFP Configuration Database manually to include SFPs that were not approved, be sure to copy your current list from the unit *before* you reset the database values. By doing so, after reset, you can then add your user-defined SFPs to the database again if they are not automatically recognized by the unit. Contact PHABRIX Support for details on SFP configuration procedures.

Update the SFP Configuration Database with the latest standard list of PHABRIX approved SFPs for the current software release as follows:

1. Click the PHABRIX button to open the Instrument Launch menu.
2. Select: **System Settings**.
3. Select: **SFP Configuration Database** from the submenu.

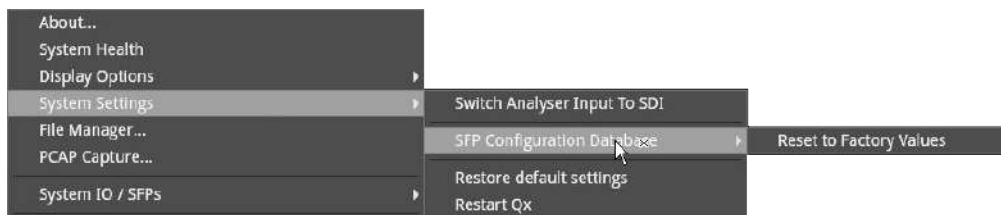

Figure 3-18: Resetting the SFP Configuration Database

4. Select: **Reset to Factory Values**.
5. Select **Reset** in the confirmation dialog.
You are warned that the database will revert to the factory defaults. Any user-defined SFP entries in the database will be deleted. To quit the reset process, select Cancel.

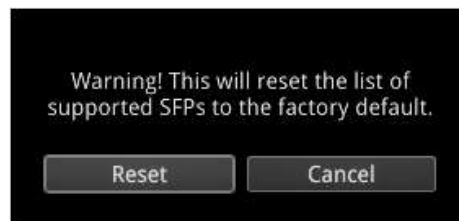

Figure 3-19: Resetting the SFP List to Factory Defaults

Note: If you have not previously modified the database, but have unsupported SFPs that you wish to use after reset, contact PHABRIX Support for information on how these might be added to the SFP database.

Upgrading the Unit

Upgrading the System Software and Firmware

New software releases will be made available regularly as the product is developed.

Software downloads are approximately 200 MB in size and can be found in the Support area of the PHABRIX website currently located at: <https://www.phabrix.com/support/product-software-downloads/>

1. Complete and submit the access request form.
2. Click the generated link to download the latest software.
3. Download the **.zip** file for the selected software release.

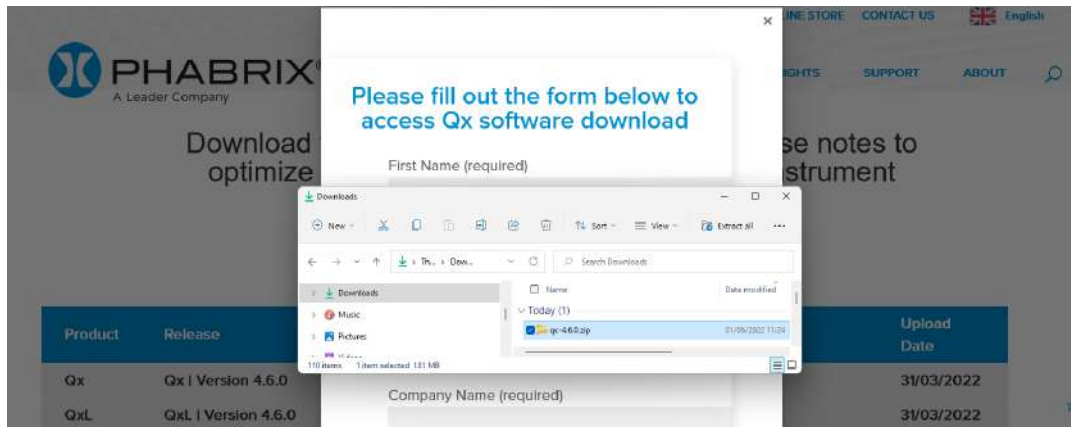

Figure 3-20: Downloading the Software Bundle from the PHABRIX Software Downloads Page

4. Copy the **.zip** file to the root directory of a FAT32 or exFAT formatted USB stick.
5. Make sure that the unit is switched OFF before upgrading.
6. Insert the USB stick into a USB port on the front panel of the unit.
7. Press the power button *twice* in quick succession. The power button changes color to **magenta** when the upgrade procedure starts. If the button does not show the magenta color, then repeat the previous steps.

The power button will flash several colors and the fans will be on full throughout the upgrade process. Please wait approximately three minutes as the unit upgrades. It will automatically display the menu screen when complete.



Remote Upgrade Using SFTP

You can upgrade the software on your unit(s) from a remote location using a standard SFTP client (e.g., FileZilla, etc.) as follows:

1. Complete and submit the access request form.
2. Click the link to download the **.zip** file for the desired software release, see above.
3. Log on remotely to a unit to be upgraded using SFTP, enter:
sftp qxuser@<Qx_IP_Address>.
For more information, see the section [Using Secure FTP \(SFTP\)](#).
4. Enter the password for the qxuser: **phabrixqx**
You should see the message **Connected to qxuser@<Qx_IP_Address>**
5. Use the SFTP **put** command to upload the upgrade **.zip** file to the upgrade directory of the unit:
/transfer/upgrade.
You should see the percentage completion and time remaining for the transfer displayed at the right of the terminal window.

```
Are you sure you want to continue connecting (yes/no/[fingerprint])?  
Warning: Permanently added '192.168.0.209' (ECDSA) to the list of known hosts.  
qxuser@192.168.0.209's password:  
Connected to 192.168.0.209.  
sftp> put qx-4.7.0.zip /transfer/upgrade  
Uploading qx-4.7.0.zip to /transfer/upgrade/qx-4.7.0.zip  
qx-4.7.0.zip          100% 183MB 11.7MB/s  00:15  
sftp> exit  
client_loop: send disconnect: Connection reset
```

Figure 3-21: Uploading the Upgrade File Remotely to the Unit

6. On completion of the upload the unit automatically detects the presence of the upgrade file and starts its upgrade cycle.

Upgrading the Software Options

You can order and install optional software toolkits at any time after purchasing your unit. You will receive an email from PHABRIX with an encrypted file attachment:

encrypted_license_file.enc.

Install the software for a toolset option as follows:

1. Make sure that the unit is powered on.
2. Download the email attachment and copy to a blank, FAT32 or exFAT formatted USB memory stick.
3. Insert the USB memory stick into any of the USB ports on the front or rear of the unit.
The unit detects the software package and displays a dialog box listing the licenses currently installed alongside the new licenses available with the option upgrade.

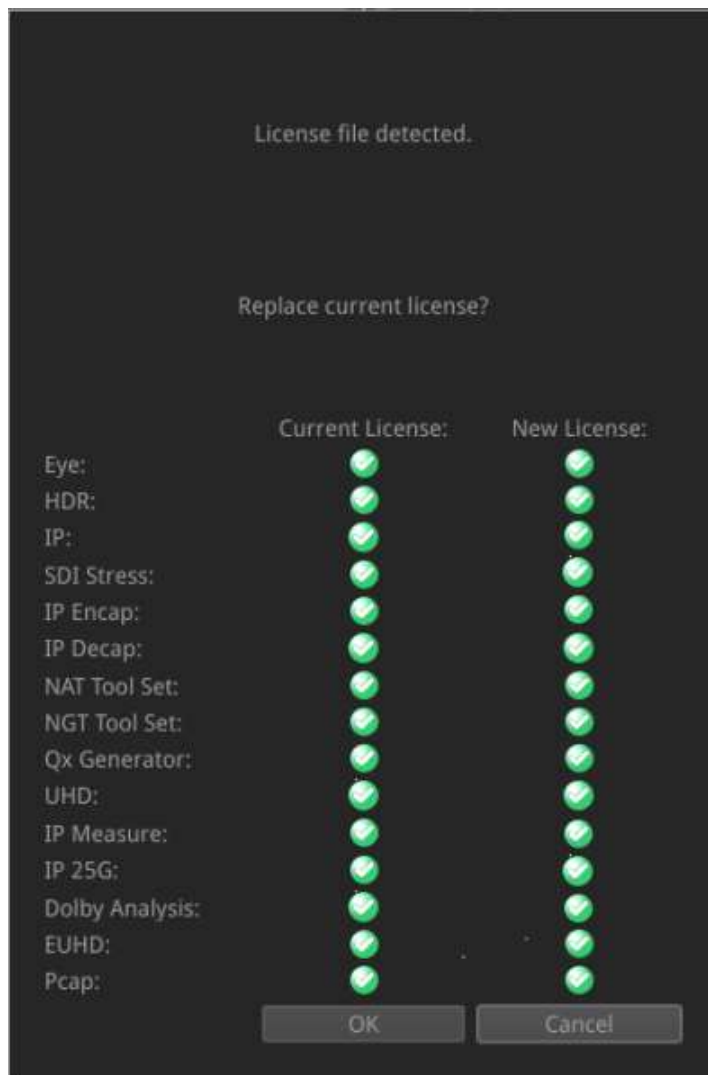

Figure 3-22: Confirmation Dialog for Software Option Upgrade

4. Make sure that the new option(s) you have purchased are listed in the **New License** column with a green check mark then click **OK** to update the license. After updating the option licenses, the unit opens a further dialog box requesting you to restart to apply your changes and activate the new option(s).

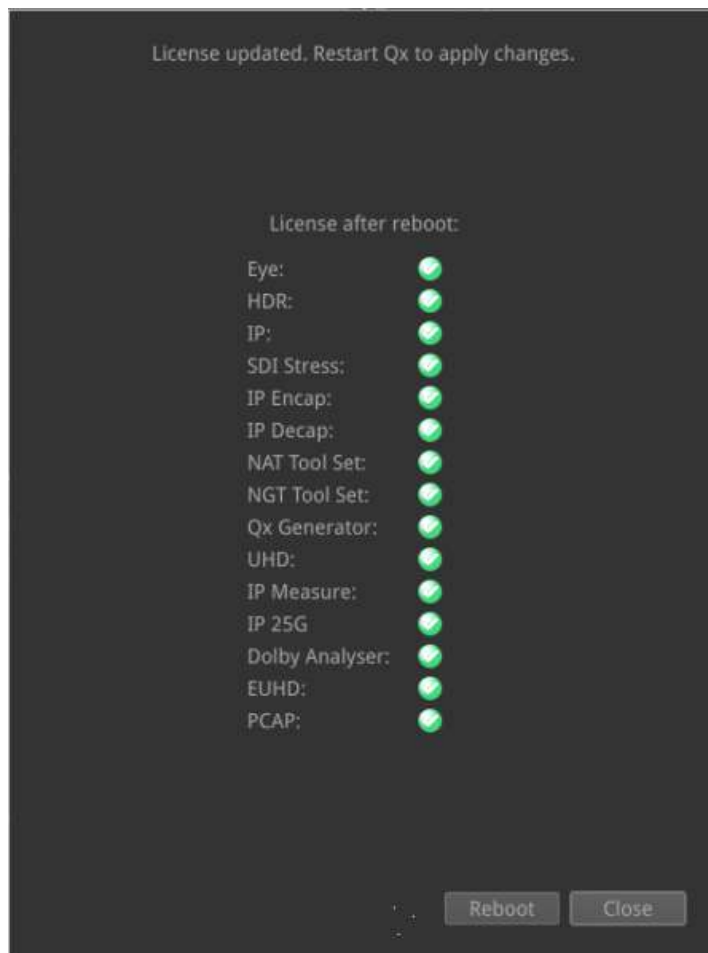

Figure 3-23: Requesting a Reboot to Activate the New Option(s)

5. Confirm that all expected licenses have been updated, then click **Reboot**. The unit reboots and the upgraded options will be available for use.
6. Select **About...** from the launch menu to display the About dialog and confirm that your new toolkit license(s) are available.

Managing Files with the USB File Manager

Overview

To transfer and manage your files, the unit provides a USB File Manager which enables you to download files from the unit to a FAT32 or exFAT formatted USB memory stick or to upload files from USB to the unit. To display the USB File Manager, simply insert a USB memory stick into one of the USB connectors on the front or rear panels of the unit. When displayed, the USB File Manager window is divided into two panes – the left-hand pane displays files available on the unit and the right-hand pane displays files and folders on the USB stick. You can either select files and then choose a copy option from the right-click menu or drag selected files and drop them into the desired target window.

Note: The unit supports a single inserted USB memory stick at any one time. If a second stick is inserted, it will not be recognized until the first USB stick is removed.

With the USB File Manager you can:

- Select files on either device
- Copy selected files in two directions (from unit to USB or USB to the unit)
- Drag and drop selected files between the unit and USB device
- Rename files on the USB stick
- Create folders on the USB stick
- Delete files from the unit or USB stick.

You can upload or download the following file types to or from the unit:

- Test patterns
- Screenshots
- Presets
- Logfiles
- TIFF image files.

The USB Device dropdown menu in the top-right of the window allows you to select either of up to three USB devices that may be connected to the USB ports. Available space on both the unit and USB stick is displayed at the bottom of each pane.

Note: The USB File Manager is disabled on a remote QxL Client.

Opening the File Manager

To open the File Manager:

- Insert a USB memory stick into one of the USB ports on the front or rear panel of the unit.

This automatically opens the following file manager dialog:

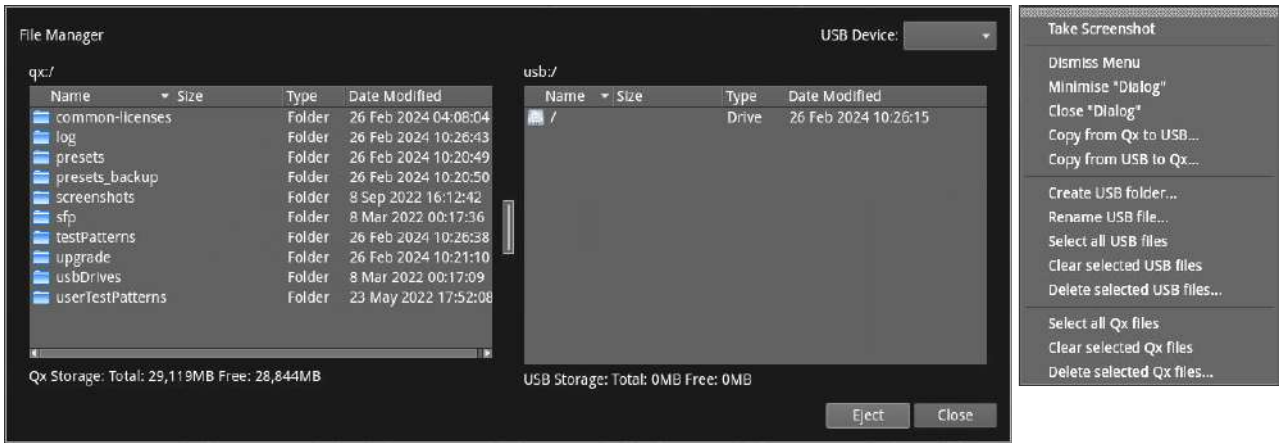

Figure 3-24: USB File Manager Window and Right-click Menu

Alternatively, you can launch the File Manager from the Instrument launch menu as follows:

- Click PHABRIX, then select **File Manager...** from the menu.

If you unintentionally close the File Manager by clicking on another window or instrument, you can re-open it from the Instrument Launch Menu as described above.

Copying Files from the Unit to USB

Copy files from the unit as follows:

1. Insert a USB stick into one of the USB ports and wait for the File Manager window to open.
2. Open the target folder on the unit.
To open a folder, double-click the folder icon.
3. Select the files to download in the left-hand pane, or choose **Select All Qx Files** from the right-click menu.

To deselect a file, simply click it again. You can also choose **Clear Selected Qx Files** from the right-click menu to deselect multiple files.

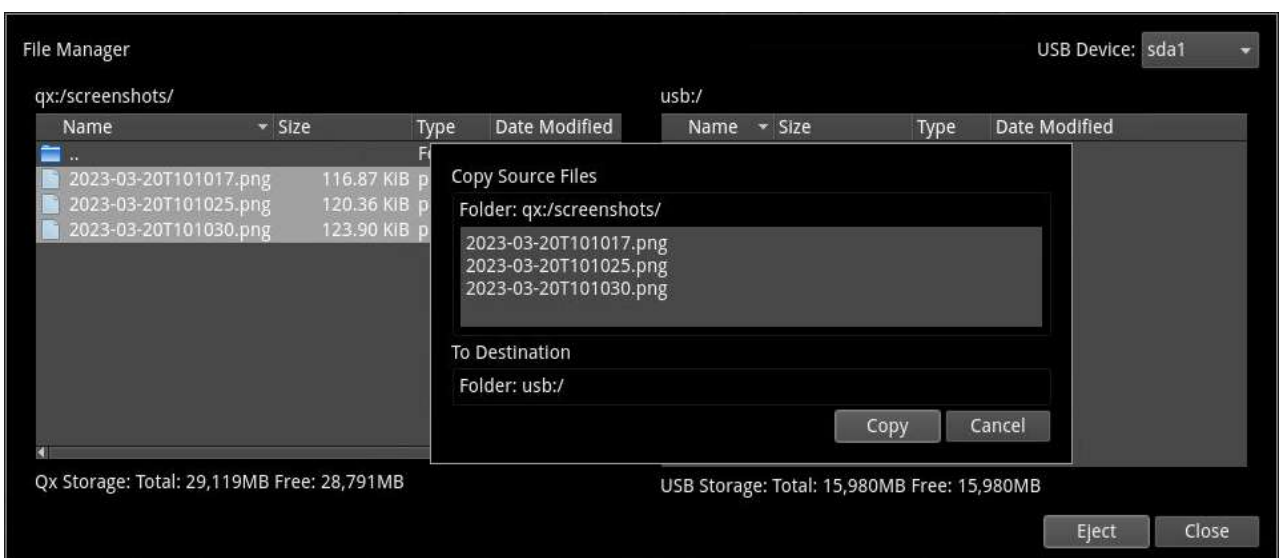

Figure 3-25: Copying Selected Files from the Unit to a Connected USB Stick

4. Right-click anywhere in the File Manager window and select **Copy from Qx to USB...** from the menu. This opens the Copy Source Files dialog.

5. Check that the selected files and destination are correct then click **Copy** to confirm.

Uploading Files from USB to the Unit

Upload files to the unit as follows:

1. Insert a USB stick into one of the USB ports and wait for the File Manager window to open.
2. Open the target folder on the unit.
To open a folder, double-click the folder icon.
3. Select the files you want to upload in the right-hand pane, or choose **Select all USB files** from the right-click menu.
4. Select the target folder on the unit, in the left-hand pane, for the uploaded files.
5. Right-click anywhere in the File Manager window and select **Copy from USB to Qx...** from the menu. This opens the Copy Source Files dialog.
6. Check that the selected files and destination folder are correct then click **Copy** to confirm.

Note: If uploading screen Presets from another unit, always reboot the unit to register the Presets on completion of the upload.

Deleting Files from the Unit

Delete files on the unit as follows:

1. Launch the File Manager from the Instrument Launch Menu.
2. Open the target folder on the unit.
To open a folder, double-click the folder icon.
3. Select the files you want to remove in the left-hand pane, or choose **Select all Qx files** from the right-click menu.
4. Right-click anywhere in the File Manager window and select **Delete selected Qx files...** from the menu. This opens the Delete Files dialog.
5. Check that you have selected the correct files then click **Delete** to confirm.

Packet Capture (PCAP)

Requires Option(s):	PHQXLO-IP-PCAP
---------------------	----------------

Overview

The Packet Capture (PCAP) function enables you to capture a snapshot of all live IP network traffic on either one, or both, of the media interfaces. You can control the PCAP function either locally from the unit's interface, or remotely, using either noVNC or a suitable VNC client viewer, for details, see [Using Virtual Network Computing \(VNC\)](#).

The PCAP data is saved to a FAT32 or exFAT formatted USB memory stick and can be transferred remotely, by browser, for offline analysis using third-party network analysis tools to investigate any issues.

Note: This function is available for ST 2110 IP input only. If the analyzer input is set to SDI, the PCAP launcher in the Settings tab of the Setup menus is inactive and grayed-out.

You can analyze the downloaded PCAP file to assist with:

- Monitoring network traffic
- Identification of network setup and performance issues
- Identification of network security vulnerabilities.

Opening the PCAP Dialog

Note: Before using PCAP, deselect any ST 2022-6 flows in the Flow Config tab of the IP Receive - Flows instrument.

Note: When using PCAP all other instruments are disabled and then re-enabled once the PCAP has completed.

To open the PCAP dialog:

1. Insert a USB memory stick into one, or more, of the USB ports on the front or rear panel of the unit, then close the File Manager.
2. Open the PHABRIX launch menu and select **PCAP Capture...**
This automatically opens the following PCAP Capture dialog:

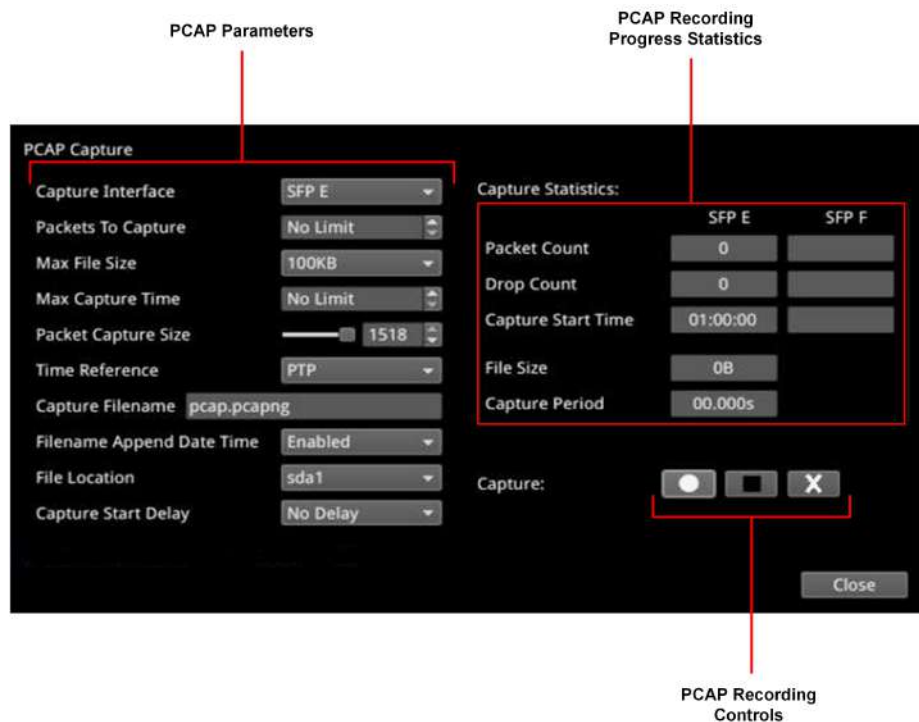

Figure 3-26: PCAP Capture Window

3. Set the desired PCAP parameters in the PCAP dialog as defined in the following table:

Table 3-4 : Parameter Settings for the PCAP Capture Instrument

Parameter	Options	Description
Capture Interface	SFP E (Default) SFP F SFP E+F	Define the SFP interface for the PCAP recording. This can be one or both media interfaces at a line rate of 10 Gbps or 25 Gbps.
Packets to Capture	No Limit (Default) 1 to 50 million	Set a limit for the number of data packets to be captured for analysis in the PCAP session.
Max File Size	100 KB 500 KB	Set a limit for the maximum size of the recorded PCAP file.

Parameter	Options	Description
	1 MB 5 MB 10 MB 50 MB 100 MB 500 MB 1 GB (Default) 4 GB	
Max Capture Time	No Limit 1 second (Default) to 9999 seconds	Set a limit for the maximum recording duration over which to record live network traffic.
Packet Capture Size	12 to 1518 bytes	Truncates each packet to the specified Packet Capture Size (length) in bytes. Use this setting to set the packet length to be large enough to capture the header information of interest, allowing the remaining payload to be discarded reducing the amount of space used by the capture. Using this parameter enables you to capture header information from more, larger packets.
Time Reference	PTP (Default) Internal clock	Specify whether to use PTP or the unit's internal clock as the reference time source for the PCAP timestamps.
Capture Filename	pcap.pcapng (Default) Or enter filename and extension using a connected USB keyboard.	If making multiple captures, this function enables you to change the capture filename to ensure that the previous packet capture file is not over-written, see PCAP File Naming Syntax .
Filename Append Date Time	Enabled (Default) Disabled	Include the current system date and time as a timestamp in the PCAP filename, see PCAP File Naming Syntax .
File Location	None sda1 (Or sdb1 , sd1 depending on insertion order and when ejected.)	Identifies the target USB slot to which to save the PCAP file, as follows: sda1 - First inserted USB memory stick USB sticks inserted subsequently are not recognized until the first inserted is ejected. Subsequent USB sticks are then labeled sdb1 and sd1 (if three USB sticks were inserted one after the other) see USB Memory Stick Identification . Options are displayed only when at least one USB stick is inserted.
Capture Start Delay	No Delay (Default) 5 s 10 s 30 s 60 s	Choose to delay the start of the PCAP capture for up to 60 seconds. When you specify a delay, the counter starts once you click the Start button. A countdown timer is displayed in the unit's status bar.

PCAP File Naming Syntax

The PCAP function saves network packet data in the PCAP next generation (**PCAPng**) format, depending on whether you choose to append a timestamp, using the following syntax:

Table 3-5 : PCAP File Naming Syntax

Capture Filename Entry	Filename Append Date Time Setting	Resulting PCAP Filename
pcap.pcapng	Disabled	pcap.pcapng
pcap.pcapng	Enabled	pcap_<timestamp>.pcapng
pcap.	Disabled	pcap
pcap.	Enabled	pcap_<timestamp>
.	Enabled	_<timestamp>

USB Memory Stick Identification

You can insert up to three USB memory sticks into the USB ports on the unit (two on the front panel and one on the rear).

Note: The unit supports a single inserted USB memory stick at any one time. If a second (or third) stick is inserted, it will not be used until the first USB stick is ejected.

After inserting up to three USB memory sticks into the unit, the name of the first identified USB is displayed in the **File Location** dropdown as **sda1**, see [Figure 3-27](#). When selected, the PCAP file is written to this USB location.

When you eject this USB using the File Manager, the unit registers the second inserted USB (if available) and the **File Location** dropdown identifies this USB stick as **sdb1**. The unit can now save the PCAP file to this USB stick. Again, when you eject the second USB, the unit registers the third inserted USB (if available) and the **File Location** dropdown identifies this USB stick as **sdc1**.

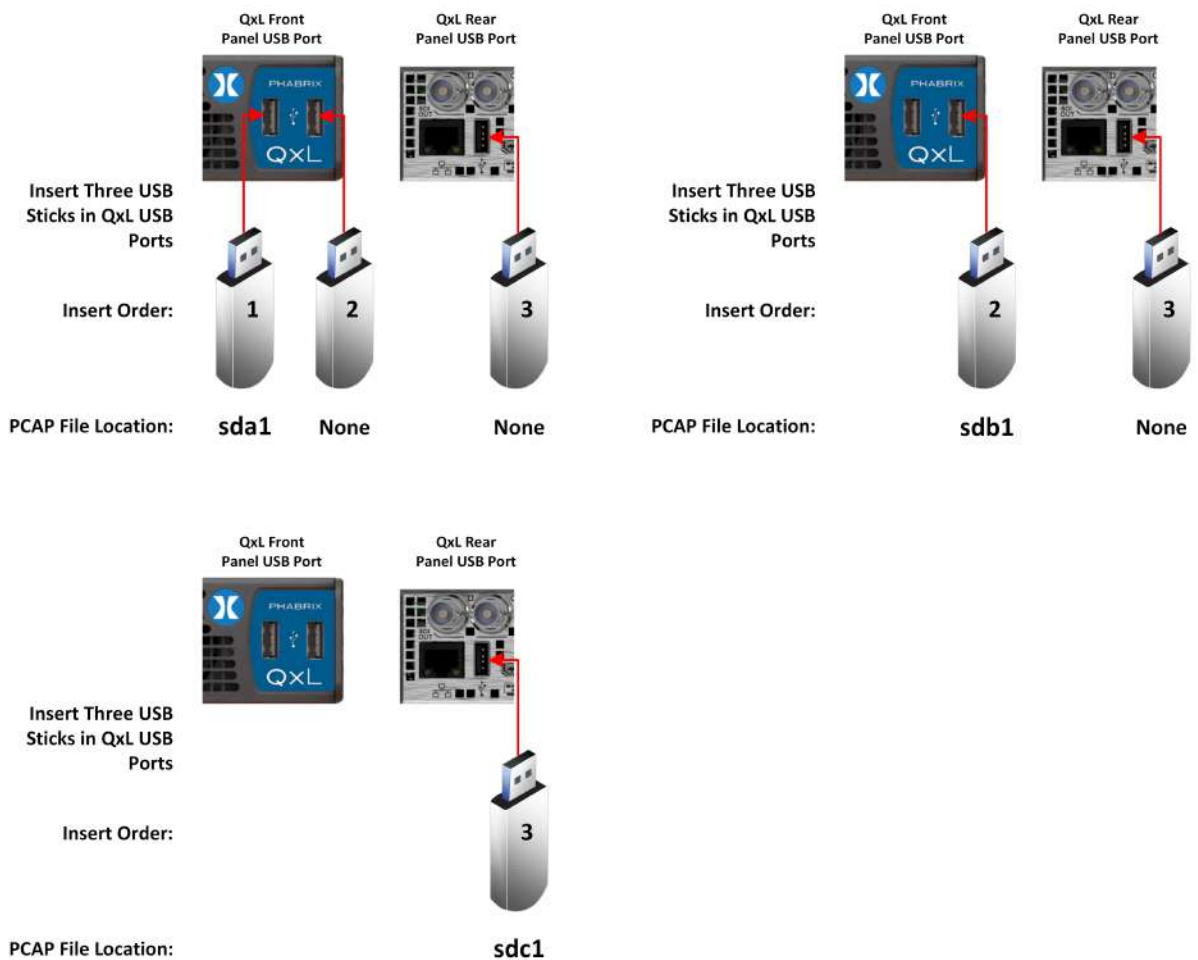

Figure 3-27: Identification of Inserted USB sticks

Starting a PCAP Recording

Once you have set the PCAP recording parameters, start a recording as follows:

1. Press the Start PCAP recording button.
2. Press the **Start Capture** control or, if you have set one, wait for the start delay counter to count-down.

You will see the message: **Capture started...** displayed in the bottom-left corner of the dialog.

3. Press the **Stop Capture** control or, if you have set a maximum file size, capture time, or number of packets, wait for the first threshold to be reached and the capture will stop automatically.

You will see the message: **Capture being stored** displayed in the bottom-left corner of the dialog as the unit transfers the captured data to the USB stick.

You can cancel the packet capture at any point by pressing the **Abort PCAP** button.

Note: The PCAP file may take some time to save to the USB stick.

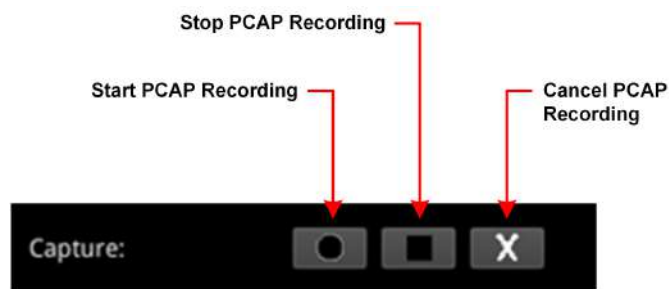

Figure 3-28: PCAP Recording Controls

4. On completion, click **Close** to quit the dialog.
5. Open the File Manager and eject the USB stick or use a browser to download it remotely to a PC.

Instrument Menu Options

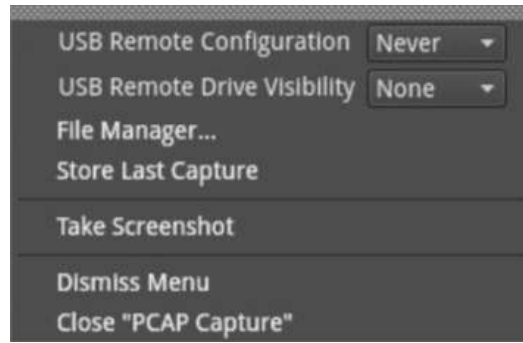

Figure 3-29: PCAP Capture Instrument Menu Options

The following table lists the configurable parameters in the PCAP options menu:

Table 3-6 : PCAP Menu Options

Item	Options	Description
USB Remote Configuration	Never Once Always	<p>Never: Do not allow remote access to the USB stick.</p> <p>Once: Allow remote access to the USB once until the unit is rebooted, at which point remote access to the USB stick is prevented.</p> <p>Always: Always allow remote access to the USB stick</p>
USB Remote Drive Visibility	None (Default) sda1 (Or sdb1 , sd1 depending on insertion order and when ejected.)	<p>Select the USB slot containing the target USB stick to allow the contents of the USB stick to be displayed in a browser.</p> <p>To access from your browser, enter:</p> <p style="text-align: center;"><code>http://qx-<Serial_Number></code> or <code>http://<IP_Address></code></p> <p>Select the usbDrives folder, then the active USB port (e.g., sda1 or other identifier). Drill-down to the PCAP file(s) saved on the USB stick. The value is automatically reset to None when the currently used USB stick is ejected.</p> <p>Note: To retrieve a PCAP file programmatically using the ReST API, use the following URL: <code>http://<qx-ID>/files/usbDrives/<usbDrive>/<PCAP filename></code> Where <code><qx-ID></code> is either <code>qx-<Serial_Number></code> or <code><IP_Address></code>.</p>
File Manager...	N/A Active Control	Select to open the File Manager directly, instead of through the launch menu. This enables you to manage and delete files on the USB stick on completion of a packet capture, or to make space for the packet capture file.
Store Last Capture	N/A Active Control	Select to save the last PCAP file, held in the unit's memory, to a USB stick. In the event of a failure preventing the PCAP file saving to USB at the first attempt, this feature ensures that you can save the last recorded PCAP file to a USB stick. A

Item	Options	Description
		PCAP file is retained in RAM until either the unit is powered down or the next PCAP, whichever comes first.



Overview

Event logging on the unit enables you to view the logs in the **Event Logging** Instrument window. The unit allocates 500 lines for logging detail before overwriting log data. It will also recall the log data last captured if the unit is started from cold. The setting for logging data will need to be re-entered from a cold start using the right-click options menu. You can also access and save Logs using the REST API.

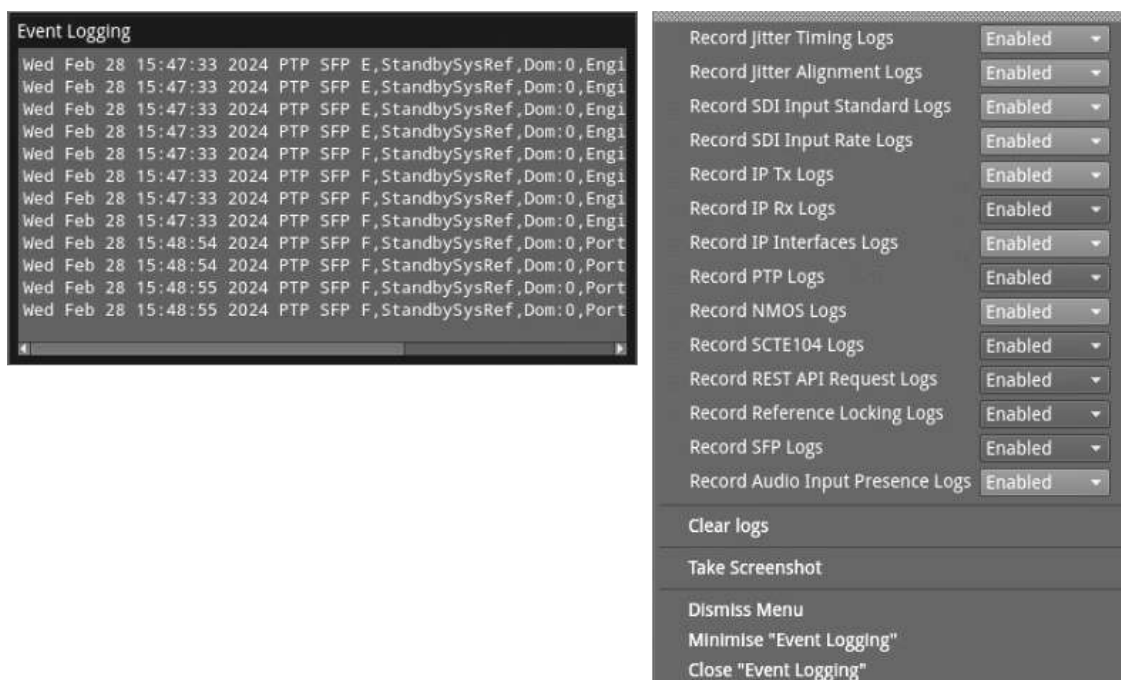

Figure 3-30: Combined (IP and SDI) Event Logging with Options Menu Showing All Logs Enabled

Available Event Logging Options

To enable event logging options, right-click the mouse in the Event Logging window to enable or disable the following logs in the Options menu:

- Record Jitter Timing Logs (Optional SDI input only)
- Record Jitter Alignment Logs (Optional SDI input only)
- Record SDI Input Standard Logs (Optional SDI input only)
- Record SDI Input Rate Logs (Optional SDI input only)
- Record IP Tx Logs
- Record IP Rx Logs
- Record IP Interfaces Logs
- Record PTP Logs (ST 2110 IP input only)
- Record NMOS Logs (ST 2110 IP input only)
- Record SCTE104 Logs
- Record REST API Request Logs
- Record Reference Locking Logs

- Record SFP Logs
- Record Audio Input Presence Logs

Select the **Clear logs** control to clear the contents of the currently active logs.

Remote Connection to the Unit

Overview

Various methods are provided to enable you to establish a remote connection to your unit, depending on your requirements, for example you could establish a remote connection using one of the following methods:

- Built-in noVNC or other standard VNC client
- REST API
- SFTP
- Web browser.

For further information on the REST API, see the section [Using the REST API for Remote Access](#).

Note: If you need to transfer files to or from a unit and you have direct access to the unit, it is recommended to use the USB File Manager available from the Instrument Launch Menu.

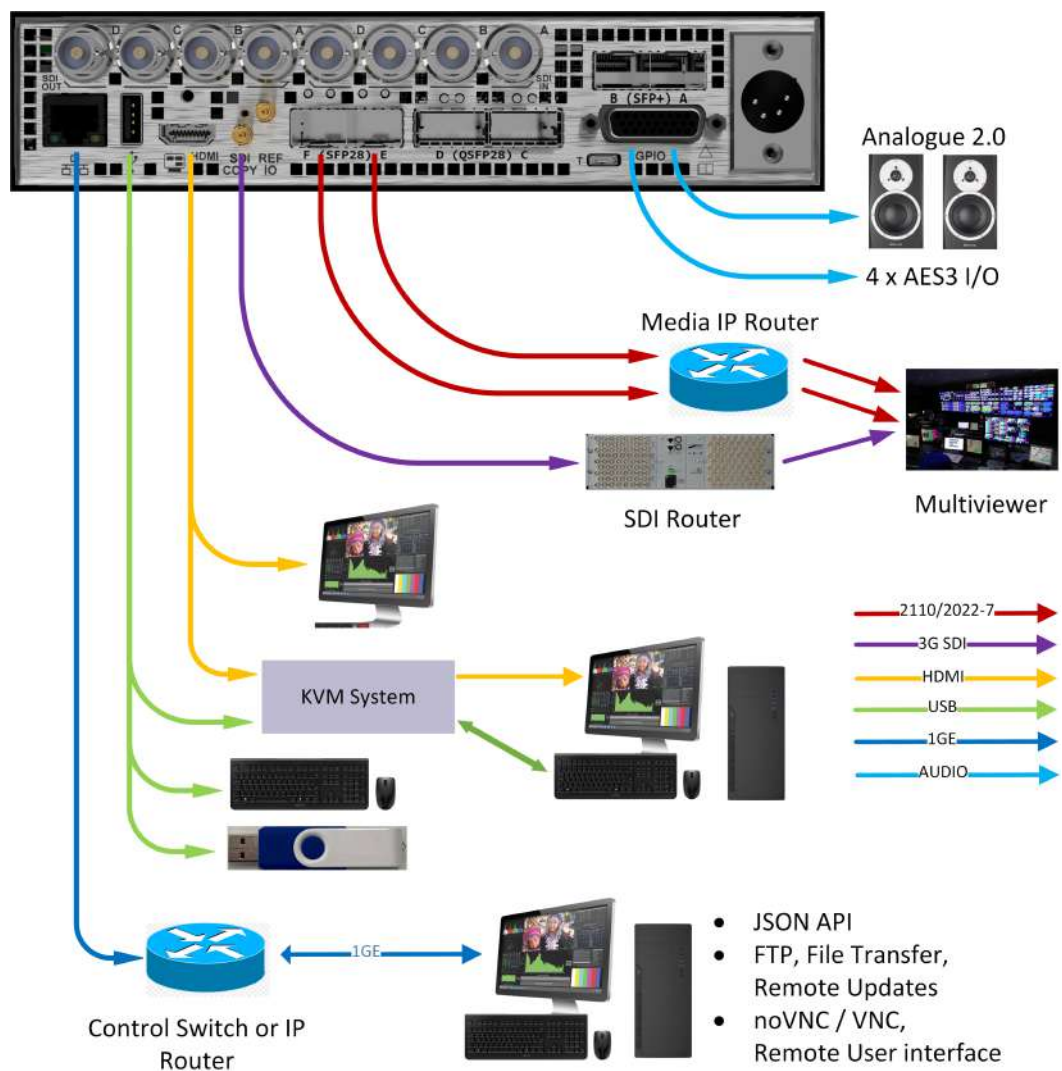

Figure 3-31: Remote Connectivity Overview

Available Functionality

Remote Operational Control:

- **noVNC:** View the screen and control the user interface from a remote location from a standard web browser using noVNC.
- **VNC:** View the screen and control the user interface from a remote location using a suitable VNC client installed on your PC.
- **REST API:** Remotely send operational control commands and retrieve data and status information.

Remote File Management:

- **SFTP:** Upgrade the unit from a remote location; available from software version 3.4.1. Retrieve Log, Preset, and Screenshot files. Delete these files. Add saved presets from a different unit. Add, retrieve, and delete user-created test pattern files.
- **Web Browser:** View and retrieve, Log, Preset, Screenshot, and User Test Pattern files. In addition retrieve PCAP files saved to an inserted USB memory stick. Alternatively, use the USB File Manager function to transfer files.

Note: In the setup directions that follow, **192.168.0.70** and **qx-020094.local** are used as examples only. Be sure to use the IP Address or mDNS Hostname specific to your unit.

Using Virtual Network Computing (VNC)

The virtual network computing or VNC facility enables you to connect from a remote location and provides you with direct screen control of the unit.

When you enable the **VNC Server** parameter in the **Qx Network & Automation** instrument, the unit allows remote access from either:

- A standard web browser using noVNC to connect to the noVNC client on the unit by way of a dedicated network socket, or
- A locally installed VNC client viewer (for example, VNC® Connect).

For more information on establishing a remote VNC connection to the unit, see the section: [Qx Network and Automation](#).

Enabling VNC on the Unit

From the **Qx Network & Automation** Instrument, enable the Options menu parameter **VNC Server**.

When enabled, the VNC Server field displays the number of current VNC connections to the unit. Once a connection is made or ended, this number is automatically updated.

Connecting to the Unit Using noVNC from a Web Browser

The following are the minimum versions of web browsers supported for use with noVNC:

- Chrome 64
- Firefox 79
- Safari 13.4
- Edge 79

Note: The Opera web browser is not supported for use with this unit.

Once the **VNC Server** is enabled on the unit, you can access the unit using noVNC from a standard web browser on your local PC as follows:

1. Enter either of the following URLs into a new browser tab:

http://<Unit_Serial_Number>/novnc

For example: **http://qx-020480/novnc**

http://<IP_Address>/novnc

For example: **http://192.168.1.72/novnc**

See the **Qx Network & Automation** instrument for the serial number or IP address of the target remote unit.

2. Click **Connect** in the noVNC title screen.



Figure 3-32: noVNC Connect Button

3. Enter the unit's password: **phabrixqx**
4. Switch the display to **full-screen mode** using the noVNC side menu.

Note: You may need to reconnect to the unit after a reboot.

Using a Generic VNC Client to Connect Remotely to the Unit

Make a remote connection to the unit using a locally installed VNC Client viewer, as follows:

1. From the Instrument Launch menu, open the Instrument **Qx Network & Automation** and right-click to open the Options menu.
2. For the option **VNC Server** select **Enabled**.
This enables the VNC server on the unit. The Network & Automation instrument displays the number of current VNC server connections.
3. Install a VNC client viewer of your choice (for example, VNC® Connect) on the remote PC and launch the viewer.
4. Initiate a connection to the unit by entering the IP address of the unit (displayed in the **Qx Network & Automation** instrument) or its mDNS Hostname (if mDNS is enabled on your computer.)
5. When required, enter the password: **phabrixqx**
A view of the desktop will open on your computer screen. You can now control the unit with your local mouse and keyboard. You should see that the number of current VNC server connections displayed in the Network & Automation instrument has increased by one.

You can now set the unit's date and time to that of an NTP server as described in the section: [Setting the Time, Date and NTP Server](#).

Note: Remote monitoring of the audio output from the unit is not available over VNC.

Using SFTP

You can use a standard SFTP client (e.g., FileZilla, etc.) to perform the following tasks on the unit:

- Upgrade the software from a remote location, see [Upgrading the Unit](#).
- Retrieve event logs, presets, screenshots and user-defined test pattern files
- Delete event logs, presets, screenshots and user-defined test pattern files
- Upload saved presets from another unit and user-defined test patterns.

Connecting to the Unit Using SFTP

Run your chosen SFTP client application on the computer from which you will connect to the unit (your SFTP server).

Enter the unit's host address using the specific IP Address of your unit or its mDNS Hostname (if mDNS is enabled on your computer), in one of the following formats:

- **sftp://192.168.0.70**
- **sftp://qx-020094.local**

In addition, enter the following details:

- Username: **qxuser**
- Password: **phabrixqx**
- Port: **22**

Once connected, open the transfer directory to access the following folders on the unit:

- **common licenses**
- **log** - for the Event Log
- **presets**

- screenshots
- sfp
- testPatterns
- upgrade
- userTestPatterns

You can download or delete files from any of these folders. In addition, you can add or upload files to the presets, upgrade and userTestPatterns folders.

Using a Web Browser

You can use a standard web browser to view and retrieve Event Log, Screenshot, Preset, and User Test Pattern files. In addition, you can access and retrieve PCAP files (IP ST 2110 only) saved to a USB stick inserted in one of the USB ports on the front or rear panel of the unit.

Connecting to the Unit Using a Web Browser

In the web browser of your choice on your computer, enter the IP address of your unit or serial number, in either of the following formats:

- **http://192.168.0.70** or
- **http://qx-<Serial_Number>.local**

For example:

- **http://qx-022228.local**

Once connected, you can access any of the following folders:

- userTestPatterns
- presets
- logs
- screenshots
- usbDrives

When connected, you should see a similar display to the following:



Figure 3-33: Instrument Popup Options Menu Displayed

View and save files to your computer as required.

Note: Files cannot be deleted using the web browser.

IP Setup and Configuration

This chapter describes the System Instruments used to setup and configure the unit for ST 2110 or ST 2022-6 IP input to the Analyzer and includes the following sections:

- [Overview](#)
- [IP Input and Output Schematics](#)
- [IP Interfaces to the Unit](#)
 - [ST 2110 Input \(Rx\) Optical SFP Interface \(Analyzer - IP Input\)](#)
 - [ST 2022-6 Input \(Rx\) Optical SFP Interface \(Analyzer - IP Input\)](#)
 - [ST 2022-6 Output \(Tx\) Optical SFP Interface \(2022-6 Transmit IP Output\)](#)
 - [Video Range Definitions for the Qx Series](#)
- [System IO for IP Input](#)
- [SFP IP Network](#)
- [LLDP Information \(ST 2110 IP Input\)](#)
- [SFP \(A, B, E, F\) - Info \(ST 2110 IP Input\)](#)
- [NMOS Status & Configuration \(ST 2110 IP Input\)](#)
- [NMOS Receivers - SDP \(ST 2110 IP Input\)](#)
- [NMOS Receivers - IS05 \(ST 2110 IP Input\)](#)
- [NMOS Senders - SDP \(ST 2110 IP Input\)](#)
- [NMOS Senders - IS05 \(ST 2110 IP Input\)](#)
- [SFP E/F - PTP Info \(ST 2110 IP Input\)](#)
- [IP Receive - Flows](#)
 - [Multicast Setup \(Multicast Requests\)](#)
 - [Flow Protocol Configuration \(Flow Config\)](#)
 - [NMOS Flow Configuration](#)
- [Analyzer - 2110 Format Setup \(ST 2110 IP Input\)](#)
- [Video Timing & System Reference \(ST 2110 IP Input\)](#)
- [AES IO Configuration \(ST 2110 IP Input\)](#)

IP Connectors and Modules

Overview

All IP connections to the unit are made using SFP+ or SFP28 (recommended) transceiver modules as shown below.

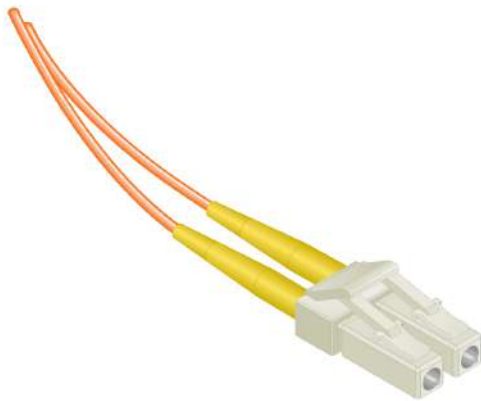

**LC-LC Type Optical Fiber
(Multimode) Connector**



**10 Gbit/s MSA SFP+ /
25 Gbit/s MSA SFP28 Optical
Transceiver Module in Cage on Rear
Panel**

Figure 4-1: Optical Fiber Connector and 10, 25 Gbit/s MSA SFP+, SFP28 Optical Transceiver Module

IP Input and Output (ST 2022-6)

The following graphic shows a schematic view of IP inputs and outputs to and from the Analyzer and Generator circuitry, using SFP28 (or SFP+) modules.

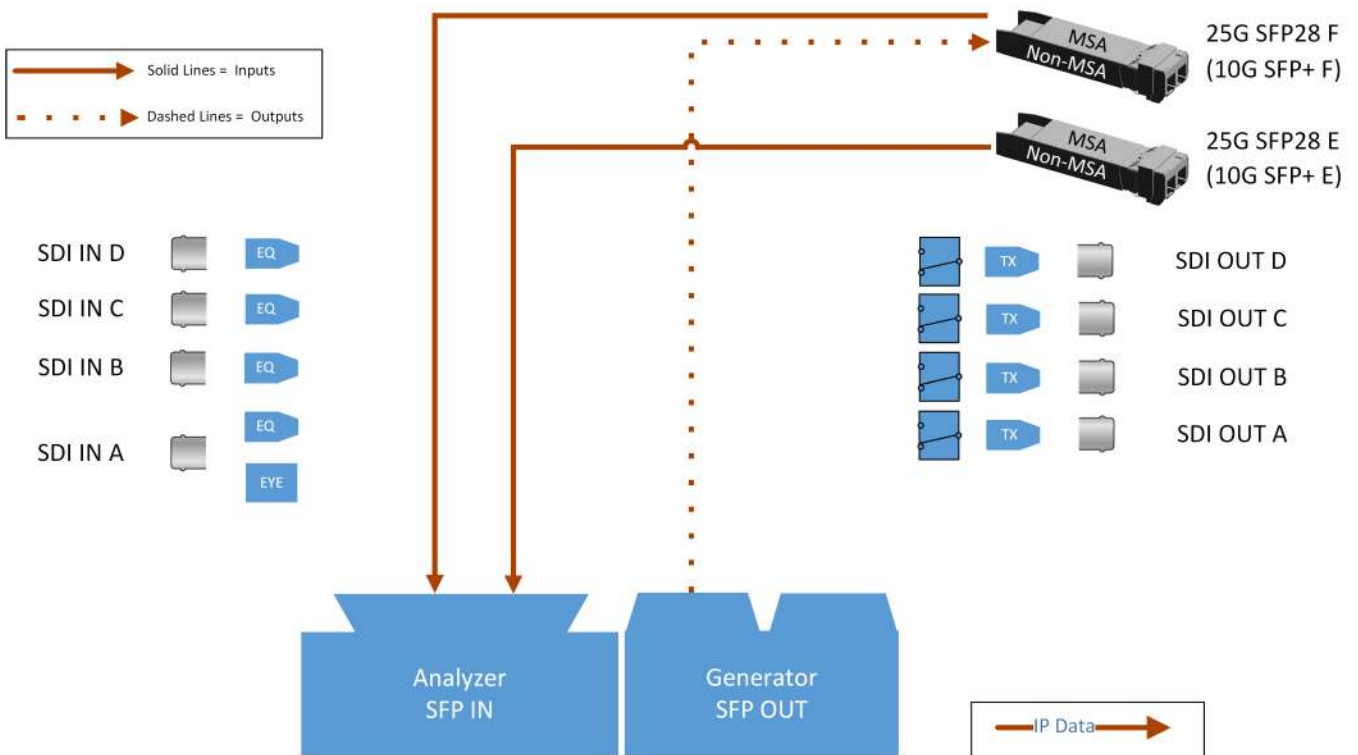

Figure 4-2: IP Input/Output Modules to Analyzer / Generator Circuitry (ST 2022-6 IP Input)

Where:

- **EQ** = SDI Cable Equalizer (Not Used with IP)
- **Tx** = Signal Transmitter
- **EYE** = Eye Processing Circuitry (SDI Only) (Factory-fitted option)
- **MSA** = Multi-source Agreement

IP Input and Output (ST 2110)

The following graphic shows a schematic view of IP inputs and outputs to and from the Analyzer and Generator circuitry, using SFP+ modules.

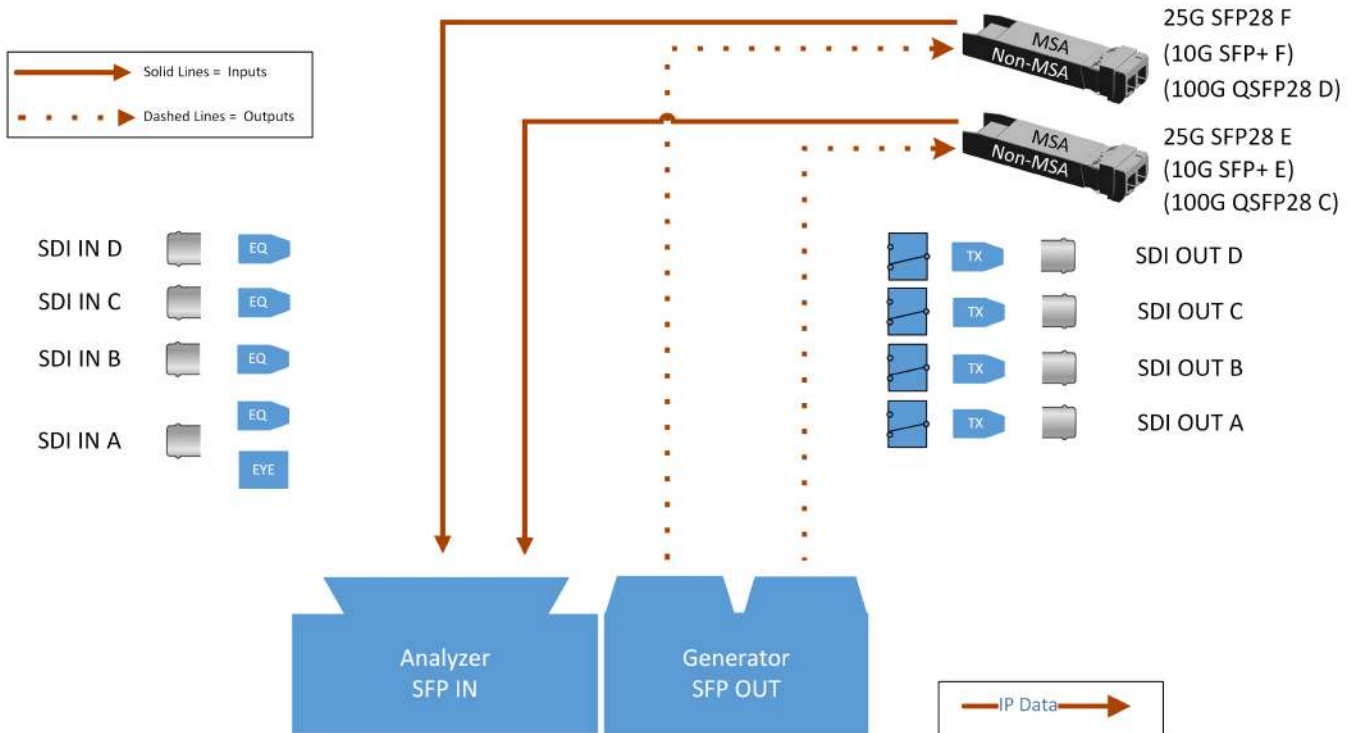

Figure 4-3: IP Input/Output Modules to Analyzer / Generator Circuitry (ST 2110)

Where:

- **EQ** = SDI Cable Equalizer (Not Used with IP)
- **Tx** = Signal Transmitter
- **EYE** = Eye Processing Circuitry (SDI Only) (Factory-fitted option)
- **MSA** = Multi-source Agreement

IP Interfaces to the Unit

Overview

The standard unit supports SMPTE standards ST 2110 and ST 2022-6 SD / HD / 3G payloads using 10G SFP+ optical transceiver modules. The option **PHQXLO-IP-25G** provides support for a higher speed connection using 25G SFP28 optical transceiver modules. In addition, advanced IP network traffic measurement tools are provided by the option **PHQXLO-IP-MEAS** and a packet interval profile generator **2022-6 Transmit (SFP F)** with **PHQXLO-IP-NGT**.

For ST 2110 Analyzer inputs, you can simultaneously analyze ST 2110-20 (video), 2110-30 (PCM) and 2110-31 (AES transport) audio, and 2110-40 ANC media flows. The unit also supports ST 2022-7 Seamless IP Protection Switching (SIPS) for both ST 2022-6 and ST 2110 IP inputs. Furthermore, hardware-based time-stamping locked to PTP ensures accurate, real-time, deterministic timing and buffer measurements of media flows through the support of ST 2059 Precision Time Protocol (PTP) on both **SFP28 E** and **SFP28 F**.

IP connections to the unit using the rear panel 25G SFP28 (or 10G SFP+) optical transceiver module(s) **SFP28 E** and **SFP28 F** are as follows:

- ST 2110 input (Rx) on **SFP28 E** and/or **SFP28 F** with ST 2059 Precision Time Protocol (PTP) on **SFP28 E** and/or **SFP28 F**.
- ST 2110 input (Rx) with ST 2022-7 SIPS on both **SFP28 E** and **SFP28 F** and ST 2059 Precision Time Protocol (PTP) or ST 2022-6 on both **SFP28 E** and **SFP28 F**.
- ST 2110 output (Tx) on **SFP28 E** and/or **SFP28 F**.
- ST 2022-6 input (Rx) on **SFP28 E** and/or **SFP28 F**.
- ST 2022-6 output (Tx) on **SFP28 F**.

With PHABRIX-supplied 10G SFP+s (**PHSFP-10GE-SR**) or 25G SFP28s (**PHSFP-25GE-SR**) you must use LC-to-LC optical, multimode duplex fiber cables for IP connections to the SFPs; the following cable specifications are approved by PHABRIX:

- OM1 (62.5/125)
- OM2 (50/125)
- OM3 (50/125)
- OM4 (50/125)

With PHABRIX-supplied 10G SFP+s (**PHSFP-10GE-LR**) or 25G SFP28s (**PHSFP-25GE-LR**) you must use LC-to-LC optical, single mode duplex fiber cables for IP connections to the SFPs; the following cable specifications are approved by PHABRIX:

- OS1 (9/125)
- OS2 (9/125)

ST 2110 Input (Rx) Optical SFP Interfaces (Analyzer - IP Input)

Both **SFP28 E** and **SFP28 F** are available as input (Rx) connections for ST 2110 IP video, audio and ancillary data (ANC) flows at 10G (or optionally 25G). Support for ST 2059 Precision Time Protocol (PTP) is available on both **SFP28 E** and **SFP28 F**.

You can analyze flows on **SFP28 E** or **SFP28 F**, or use both interfaces in tandem in a **Seamless IP Protection Switching (SIPS)** configuration where ST 2022-7 functionality provides seamless reconstruction of flows by using the *best* packets presented on either interface.

You can define the video and audio flow parameters in the **Analyzer - 2110 Format Setup** Instrument. In addition, the software provides enhanced ST 2110 IP measurement capabilities with the optional license **PHQXLO-IP-MEAS** including:

- ST 2110 **VRX_{Full}**
- ST 2110 **C_{Max}**
- Advanced video timing
- Dual-port interpacket timing windows

ST 2110 Output (Tx) Optical SFP Interfaces (Generator or Monitor Flows - IP Output)

Both **SFP28 E** and **SFP28 F** are available as output (Tx) connections for ST 2110 IP video, audio and ancillary data (ANC) flows at 10G (or optionally 25G) over IP.

You can transmit Generator or Monitor flows on **SFP28 E** or **SFP28 F**, or use both interfaces **SFP28 E+F** in tandem in a **Seamless IP Protection Switching (SIPS)** configuration where ST 2022-7 functionality provides seamless reconstruction of flows by using the *best* packets presented on either interface.

You can define the video, audio and ancillary flow parameters in the **2110 Transmit** Instrument. For more information, see the section [2110 Transmit \(ST 2110 IP Output\)](#).

ST 2022-6 Input (Rx) Optical SFP Interface (Analyzer - IP Input)

Both **SFP28 E** and **SFP28 F** are available as input (Rx) connections for ST 2022-6 input flows at 10G (or optionally 25G).

You can analyze flows on **SFP28 E** or **SFP28 F**, or use both interfaces **SFP28 E+F** in tandem in a **Seamless IP Protection Switching (SIPS)** configuration where ST 2022-7 functionality provides seamless reconstruction by using packets from either flow to compensate for possible packet loss or corruption.

You can use the **Analyzer - Video Standard (SDI & 2022-6)** instrument to override the parameters of the received SDI signal or ST 2022-6 flow, if necessary. For example, if the video rendering shows that the ST 352 payload data is wrong or inaccurate, you can use your knowledge of the correct parameters to override those that are incorrect. If you do not know the correct parameters but the video rendering is unsatisfactory, you can choose to ignore the ST 352 payload identifiers and allow the unit to estimate the parameter values.

ST 2022-6 Output (Tx) Optical SFP Interface (2022-6 Transmit IP Output)

The Generator transmit (Tx) connection for IP ST 2022-6 video is **SFP28 F**. This is the left-most SFP28 cage when viewed from the rear. This output provides the ST 2022-6 IP video packet generation at 10G (or optionally 25G) over IP.

Video Range Definitions for the Qx Series

The Qx Series supports the analysis of 10 or 12 bit video signals for all inputs. For each RGB or YCbCr color channel in a 10 bit video signal there are 1024 possible values, from **0 to 1023**. In the Qx Series, this represents the **Full Range**, abbreviated to **FR** when manually defining standards. See [Figure 4-4](#), adapted from EBU R 103, for a schematic overview.

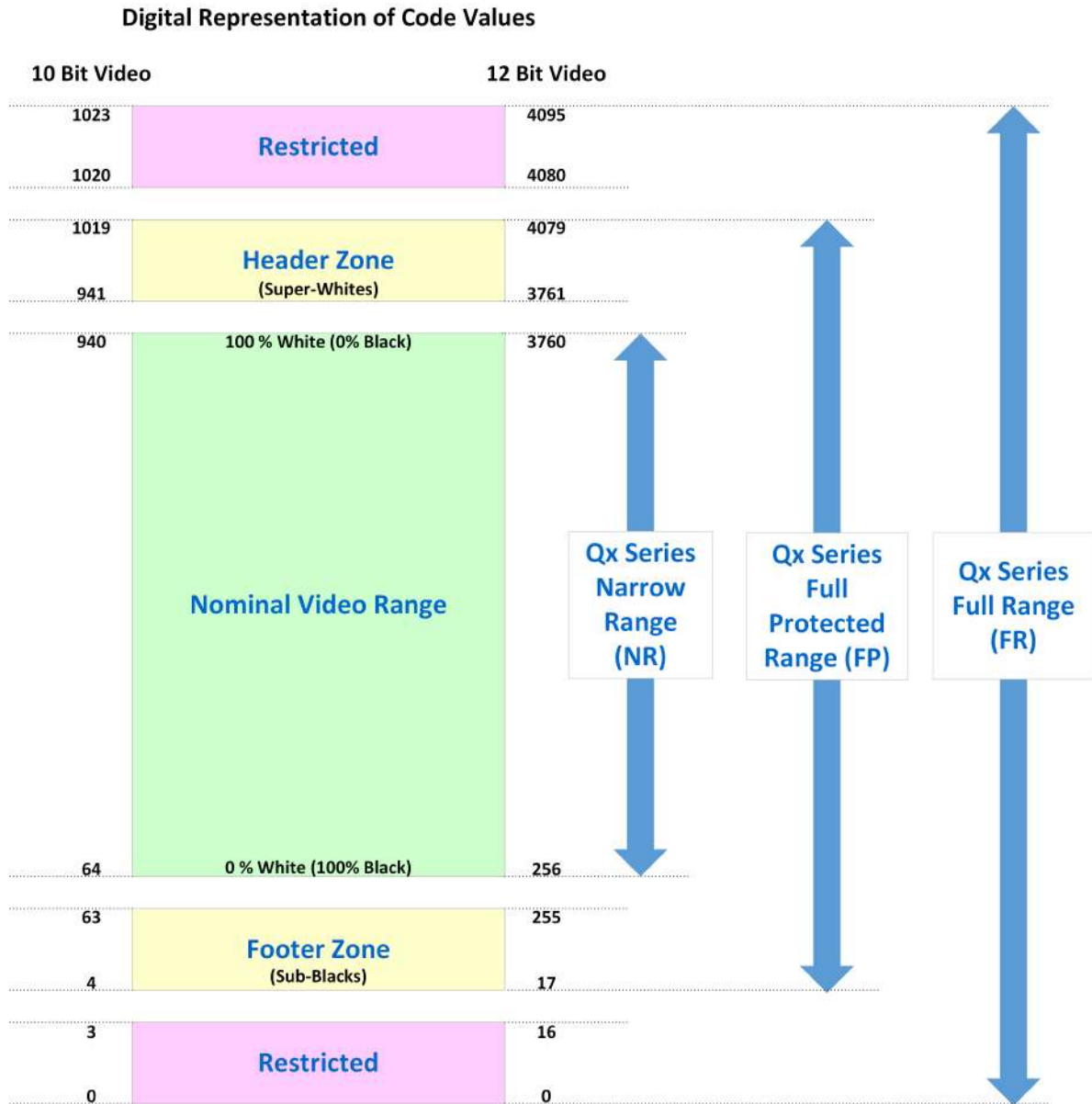

Figure 4-4: Typical Video Bit Code Values and Equivalent Qx Series Range Definitions

SMPTE defines the first 4 bits (**0 to 3**) and last 4 bits (**1020 to 1023**) of a 10 bit video signal as reserved for signal processing requirements so these must not contain video data. This leaves the range of available bits for color display as **4 to 1019**, where this specific range is referred to as the **Full Protected Range** in the Qx Series (for 10 bit video) and abbreviated to **FP**. In this range, **4** represents the darkest black of the sub-blacks and **1019** the brightest white of the super-whites at the bottom and top of the color scale respectively.

The nominal video range for a 10 bit video signal is the code range extending from 100% Black to 100% white, excluding the sub-blacks and super whites. For a 10 bit video signal this range is between bits **64** and **940** and is defined as **Narrow Range (NR)** in the Qx Series.

In addition, EBU R 103 defines a header zone between the nominal video range and the restricted bits at the upper extent of the range and a footer zone between the nominal video range and the restricted bits at the lower extent of the range. The Qx **Full Protected** range includes both header and footer zones for 10 and 12 bit video signals. The header and footer zones, containing the super-whites and sub-blacks respectively, are intended as buffer zones in case color ranges exceed the upper or lower limits of the nominal video range. When converting from YCbCr to RGB formats and *vice versa*, the foot- and headroom provide buffer space if required. The number of bits in the header and footer depends on the bit depth of the video signal.

Similarly, for a 12 bit video signal there are **4096** possible values giving the Full Range (**FR**), from **0** to **4095**. In this case, the first and last 15 bits are reserved for signal processing so the Full Protected Range (**FP**) for a 12 bit video signal is **16 to 4079**.

To summarize, the following table shows the Full, Full Protected and Narrow ranges as implemented in the Qx Series:

Range Terminology in Qx Series	10-Bit Code Values	12-Bit Code Values
Full Range (FR)	0 - 1023	0 - 4095
Full Protected Range (FP)	4 - 1019	16 - 4079
Narrow Range (NR)	64 - 940	256 - 3760

For more detailed information about video signal ranges, see the EBU recommendation R 103 *Video Signal Tolerance in Digital Television Systems*.

Overview

Due to the complexity of the UHD TV standards, PHABRIX has introduced innovative ways to display status information. The **System IO** Instrument provides a quick overview of the signal inputs and outputs connected to the unit. In addition, System IO displays the status of signal interfaces and the external reference.

You can also use this instrument to switch inputs to the analyzer between IP and SDI (BNCs or SFPs) by tapping or clicking the appropriate connector icon. This enables you to switch input to the Analyzer without changing the Toolbar softkeys or switching to the Settings tab of the Setup Menus, see the section [Switching Between Analyzer Inputs](#).

The System IO window displays the status of signal inputs and outputs, external reference, and type of interface connector fitted.

System IO for IP Inputs

The unit can both receive and transmit either ST 2022-6 or ST 2110 IP flows by way of the active SFP28 interface modules, which are represented in the System IO window by color-coded connector icons. The color of the connector icons corresponds to the color of either the Analyzer (Orange, Rx) or Generator (Cyan, Tx) instruments, to aid recognition.

Note: You can change the representative colors for the Analyzer and Generator in the [Display Settings](#) dialog.

An entirely grayed-out connector indicates that a signal is not present. If an SFP28 is unseated or not present, this is displayed graphically with a black void to indicate a missing SFP28.

The tables display SFP28 type and presence information, together with external reference standard and status overview.

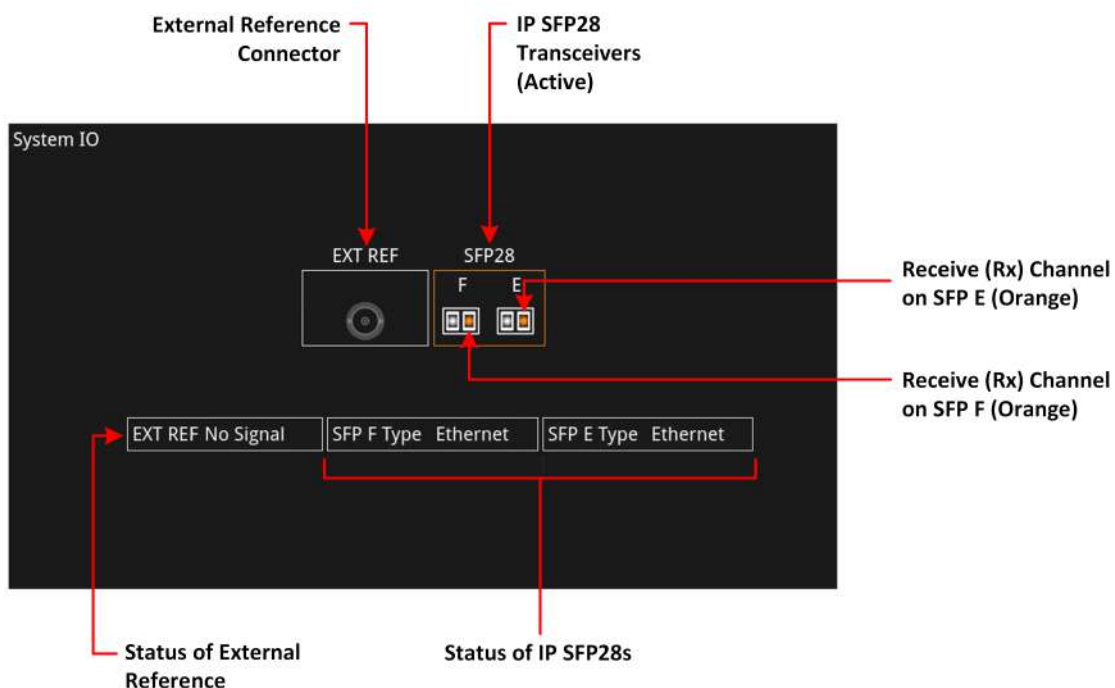

Figure 4-5: System IO Instrument on IP only Unit (Without Factory-fitted SDI Option)

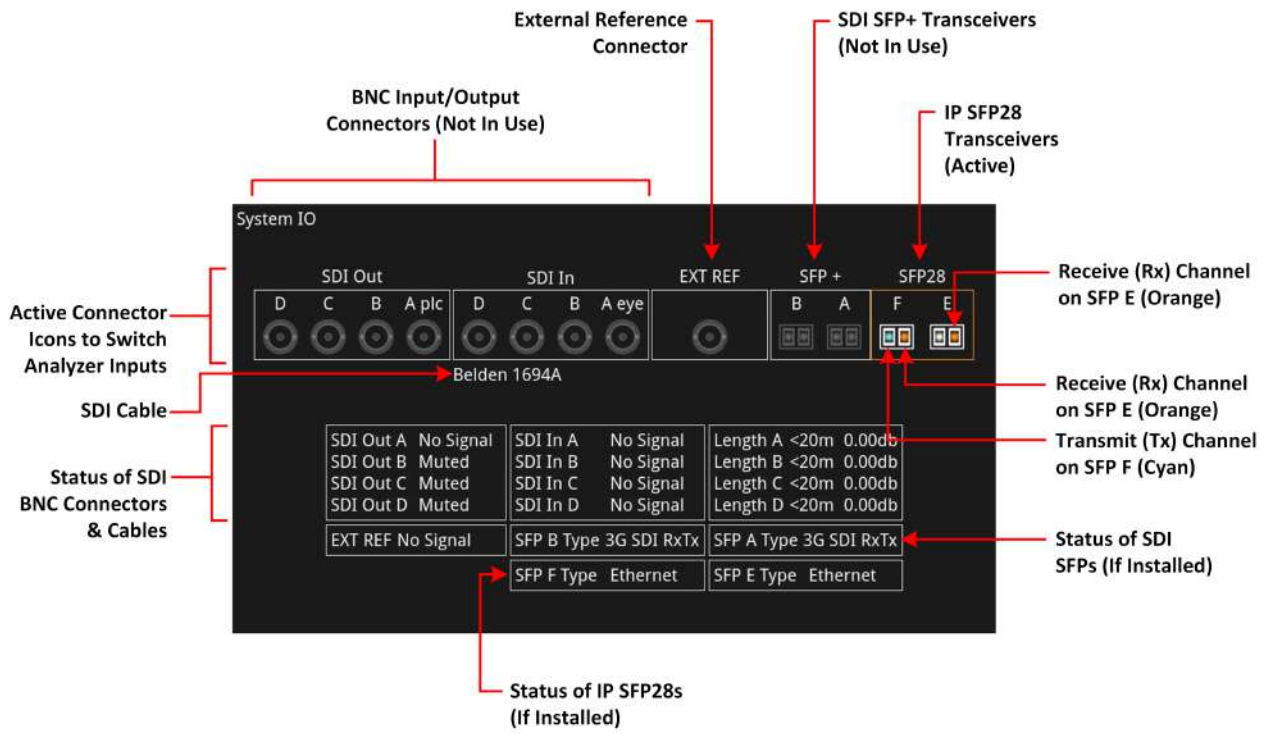

Figure 4-6: System IO Instrument Showing SFP E (Rx) and SFP F (RxTx) (With Factory-fitted SDI Option)



Overview

The **SFP IP Network** instrument provides an overview of the status of the unit's SFP interfaces used for ST 2022-6 IP packet transmission (**SFP28 F**) and reception (**SFP28 E**), and for ST 2110 IP packet reception or transmission (**SFP28 E and F**). This window displays the following parameters:

- **SFP28 E, SFP28 F** presence
- Carrier signal presence
- Interface Status
- SFP MAC and IP addresses
- Domain Name System (DNS) Server IP address
- Packet information
- IGMP maximum version status.

SFP IP Network		IGMP: Max V3	
	SFP E	SFP F	
Carrier Signal	Present	Present	
Interface	Up	Up	
MAC Addr	00:1F:7F:01:55:F4	00:1F:7F:02:55:F4	
IP Addressing Mode	Dynamic	Dynamic	
IP Addr	192.168.10.14 / 24	192.168.20.17 / 24	
Gateway	192.168.10.254		
DNS IP Addr	192.168.10.254	192.168.20.254	
Total Tx pkts	1338371	1221414	
Total Rx pkts	296456478757	136048482316	
SFP E :			
SFP F :			

Figure 4-7: SFP IP Network Instrument

Note: If you insert a 25G SFP in either the SFP E or F module cages when the 25G IP license (**PHQXLO-IP-25G**) is not installed, the Instrument title will change color to red. If you hover the cursor over the title the following error message is displayed:

Error: IP 25G License: Not Present. Inserted 25G SFPs will not function.

In addition, error status information is displayed at the foot of the window.

Instrument Menu Options

Right-click in the instrument window to display a submenu you can use to set the IP address (DHCP or Static) and network/subnet mask of each SFP using a USB keyboard or on-screen keypad.

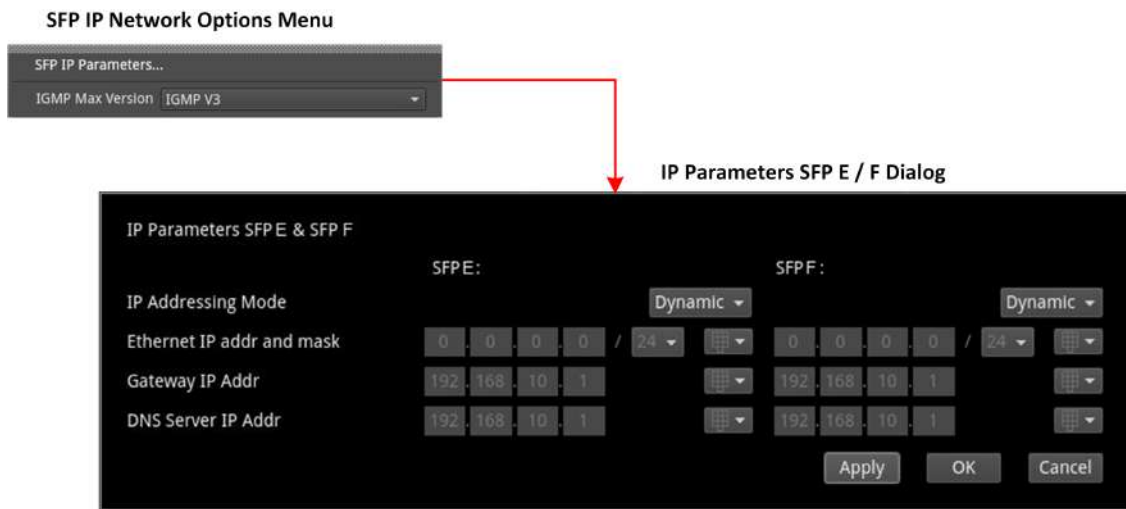

Figure 4-8: SFP IP Network Menu Options

The following table lists the configurable parameters in the SFP IP Network instrument submenu:

Table 4-1: SFP IP Network Options

Item	Options	Description
SFP IP Parameters E & SFP F		
IP Addressing Mode	Dynamic (Default) Static	Select the method to set the IP address of the SFP, either automatically, using DHCP, or manually, by entering the IP address directly. When set to Dynamic (default), the IP address, mask, gateway and DNS fields are grayed out and these details are assigned automatically. When set to Static, the IP addressing fields are activated, allowing you to enter the IP details manually.
SFP E / F IP Addr and Mask	Automatically allocated (Dynamic) or Manual Entry (Static)	IP address and mask of the SFP. Mask selection is by way of a dropdown menu; set mask in range 8 to 31. Classless Inter-Domain Routing (CIDR) notation is used with a default value of /24 (i.e., 255.255.255.0)
SFP E / F Gateway IP Addr	Automatically allocated (Dynamic) or Manual Entry (Static)	IP address of the SFP Gateway.
SFP E / F DNS IP Addr	Automatically allocated (Dynamic) or Manual Entry (Static)	IP address of the DNS server. Set IP address of DNS Server as required, for example, when manually configuring for use with NMOS.
Apply SFP E / F IP Parameters	Instrument Control	Apply and save the IP addresses when manually allocated.
IGMP Max Version		
IGMP Max Version	IGMP V3 (Default) IGMP V2 IGMP V1	Represents the highest supported version of the Internet Group Management Protocol (IGMP). Currently version 3 is the highest supported version. In the event that the network is running IGMP version 2 or version 1, the unit automatically switches down to the lower version of the protocol. Currently there is no visual display of the version at which the unit is running.

Item	Options	Description
		You can set the maximum allowed IGMP version using this instrument. Selecting the highest available IGMP Max Version will affect all IGMP requests (including both PTP and Media Flows requested through the IP Receive - Flows instrument.)



Overview

Link Layer Discovery Protocol (LLDP) is a link layer protocol used by network devices to advertise their identity, capabilities and neighbors. The **LLDP Info** Instrument is particularly useful as an in-band method when you need to identify the port and device to which the unit is connected at the other end of a wired Ethernet link on a local area network.

LLDP Info		LLDP: Active	
	SFP E Neighbour	SFP F Neighbour	Mgmt Neighbour
Sys Name	switch-16628c	switch-cc463e	No data
Sys Descr	MSN2010,Onyx,SWv3,....	MSN2010,Onyx,SWv3,....	
Chassis ID	EC:0D:9A:FC:D0:00	50:6B:4B:8E:67:C0	
Port ID	Eth1/18	Eth1/18	
Port Descr			
Mgmt IP	192.168.10.254	192.168.20.254	
Primary VLAN	0	0	

Figure 4-9: LLDP Info Instrument

When you enable LLDP send and receive, the unit searches for neighboring LLDP-enabled devices connected to SFP E, SFP F and the Management Port. The unit reports the following data items:

- System Name
- System Description
- Chassis ID
- Port ID
- Port Description
- Management IP Address
- Primary VLAN ID.

When disabled, no LLDB information is reported.

The unit can provide the following information over LLDP:

Table 4-2 : LLDP Information Provided

Item	Unit Reports
System Name:	Serial number
System Description:	PHABRIX Qx and Software Version Number
Chassis ID and subtype:	Unit Management MAC address
Port ID and subtype:	Unit Management MAC address
Port Description:	<ul style="list-style-type: none"> • Eth0 (Management) • phabEth0 (SFP E) • phabEth1 (SFP F)
Management IP Addresses:	Management IP address

Instrument Menu Options

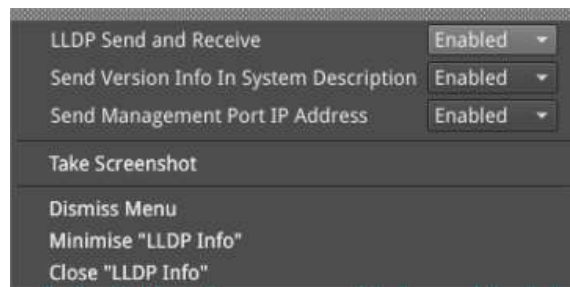

Figure 4-10: LLDP Info Menu Options

The following table lists the configurable parameters in the LLDP Info instrument options menu:

Table 4-3 : LLDP Info Menu Options

Item	Options	Description
LLDP Send and Receive	Enabled Disabled (Default)	When disabled, restricts some of the information that is communicated over LLDP, for example, when considering the IT security of your system. You can enable these parameters to allow routine maintenance.
Send Version Info in System Description	Enabled (Default) Disabled	Displayed only when LLDP Send and Receive is enabled. When disabled, the system description will indicate only PHABRIX Qx and will not advertise the software version number.
Send Management Port IP Address	Enabled (Default) Disabled	Displayed only when LLDP Send and Receive is enabled. When disabled, the unit will not advertise its management IP address.

SFP (A, B) / (E, F) - Info



Overview

The **SFP - Info** windows provide at-a-glance physical status information on each SFP module, including Identifier, connector type, line code (encoding), and vendor details to check compatibility for use with the unit. Status information for the SFP, including temperature and voltage, is also displayed.

SFP F - Info		Temperature: 43.3 °C Voltage: 3.26 V Rx Power: 1.04 mW Tx Power: 1.05 mW	
Status	Approved	Optical Wavelength (nm)	850
Vendor	Mellanox	SFF 8472 Compliance	SFF 8472 Rev 12.3
Part No	MMA2P00-AS	Temp High Warning (°C):	70.0
Vendor OUI	00-02-C9	Temp Low Warning (°C):	0.0
Revision	A3	Temp High Alarm (°C):	80.0
Serial No	MT1835FT02478	Temp Low Alarm (°C):	-10.0
Identifier	SFP or SFP+	Voltage High Warning(V)	3.47
Ext Identifier	GBIC/SFP function via two-wire only	Voltage Low Warning (V)	3.14
Connector Type	LC	Voltage High Alarm (V)	3.50
Encoding	64B/66B	Voltage Low Alarm (V)	3.10
Extended Compliance	100GBASE-SR4/25GBASE-SR	Tx Power High Warning (mW):	1.74
Rate Identifier	Unspecified	Tx Power Low Warning (mW):	0.14
Supported Link Length Smf (km)	0	Tx Power High Alarm (mW):	3.47
Supported Link Length Smf (m)	0	Tx Power Low Alarm (mW):	0.07
Supported Link Length OM1 (m)	0	Rx Power High Warning (mW):	1.74
Supported Link Length OM2 (m)	0	Rx Power Low Warning (mW):	0.09
Supported Link Length OM3 (m)	70	Rx Power High Alarm (mW):	3.47
Supported Link Length OM4 / Copper (10m / m)	10	Rx Power Low Alarm (mW):	0.05
Bit Rate (MBd)	25750		

Figure 4-11: SFP (A, B) / (E, F) - Info Instrument (Full Screen Size)

Note: If you insert a 25G SFP in either the SFP E or F module cages when the 25G IP license (PHQXLO-IP-25G) is not installed, the Instrument title will change color to red. If you hover the cursor over the title the following error message is displayed:

IP 25G License not present, please use a 10G ethernet SFP.

Instrument Menu Options

The following table lists the configurable parameters in the (A, B) / (E, F) - Info instrument submenu:

Table 4-4 : SFP (A, B) / (E, F) - Info Instrument Menu Options

Item	Options	Description
Power Units	mW (Default) dBm	Units displayed for SFP Rx/Tx optical power.

NMOS Status Overview & Configuration (ST 2110 IP Input)



Overview

The AMWA NMOS toolset supports **IS-04 Discovery and Registration** (versions 1.0, 1.1, 1.2 and 1.3) and **IS-05 Device Connection Management** (versions 1.0 and 1.1). Support is also provided for the discovery of PTP Domain Number by way of **IS-09 System Discovery**. The unit supports discovery over both multicast DNS (mDNS) and unicast DNS-SD as described in the requirements (*JT-NM TR1001-1:2018*) as well as manual entry of the NMOS Registry address.

The **NMOS** Instrument displays status information about the unit when acting as an NMOS receiver or sender, providing the following:

- NMOS Node current status (Enabled or Disabled)
- DNS Search Domain (Local or Domain name)
- Operating mode (Registered or Peer to Peer)
- Registration Discovery (Manual or Automatic)
- Registration URL
- Receiver Mode (NMOS interface type, dual or single)
- Sender Mode (NMOS interface type, dual or single)
- Configure with IS-09 (Enable or disable remote discovery of PTP domain number).

For details, see the [NMOS Options Menu](#).

NMOS	
NMOS Node	Enabled
DNS Search Domain	Local
Operating mode	Registered
Registration Discovery	Manual
Registration URL	http://192.168.10.254:8010/x-nmos/registratio...
Receiver mode	Dual interface
Sender mode	Dual interface
Configure with IS-09	Disabled

Figure 4-12: NMOS Instrument - Status Overview (ST 2110 IP Input)

For additional NMOS instruments in the group, see:

- [NMOS Receivers - SDP \(ST 2110 IP Input\)](#)
- [NMOS Receivers - IS05 \(ST 2110 IP Input\)](#)
- [NMOS Senders - SDP \(ST 2110 IP Input\)](#)
- [NMOS Senders - IS05 \(ST 2110 IP Input\)](#).

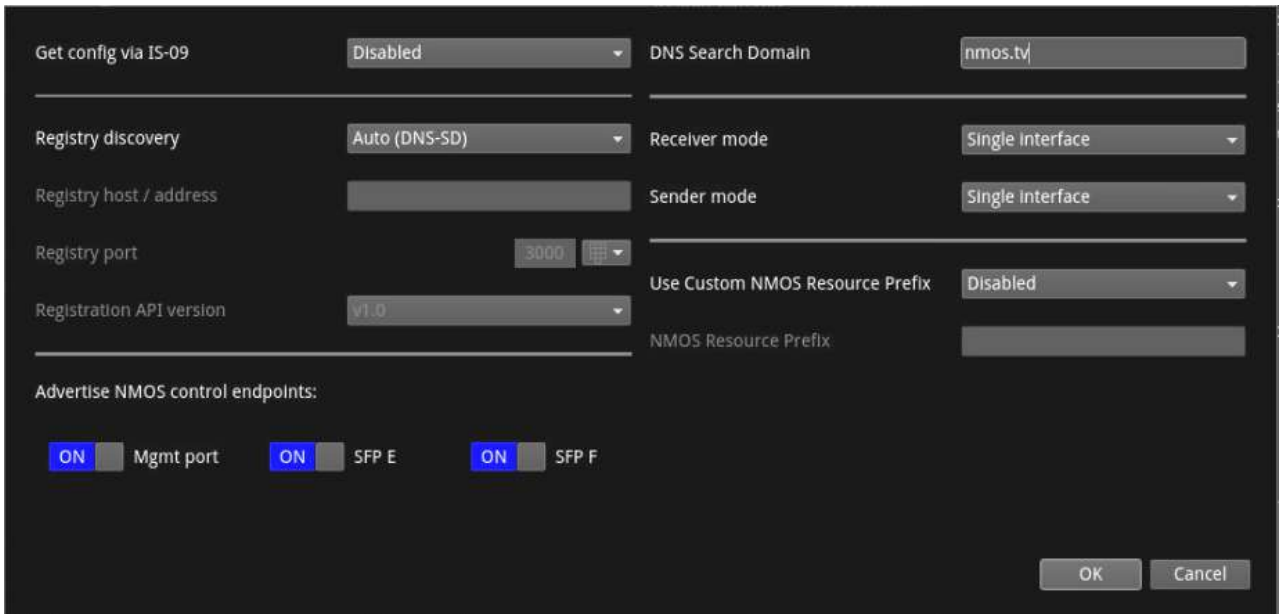

Figure 4-13: NMOS Generic Configuration Dialog (ST 2110 IP Inputs)

As a component of an NMOS-enabled environment, the unit can register its presence with the NMOS Registry as either a pair of single interface nodes, or as a dual interface node, for all ST 2110 flow types.

Use the configuration dialog of the NMOS Instrument to enable / disable the unit as an NMOS node and, when enabled, set the NMOS communication parameters of the node. This configuration is used by the following, additional instruments in the NMOS Group:

- NMOS Receiver - SDP
- NMOS Receiver - IS05
- NMOS Sender - SDP
- NMOS Sender - IS05.

An overview of the components comprising the NMOS Group is shown in [Figure 4-14](#) For more information on each of these NMOS instruments, see the corresponding section.

Once registered as a receiver or sender node, you can use an NMOS Controller to manage the active connections with the unit.

The choice of single/dual interface for the NMOS receiver or sender node is independent of the choice of ST 2022-7 SFP E, SFP F, or Seamless SFP E+F mode selection.

Note: In the event that the unit is unable to locate the NMOS Registry, it will revert to NMOS Peer to Peer mode and display **Peer to Peer** in place of the NMOS Registry IP address and port number.

Any changes to connectivity made by the NMOS Controller are dynamically reflected in the corresponding NMOS Instrument.

To troubleshoot your NMOS environment, you can enable the recording of NMOS Logs in the [Event Logging](#) instrument.

NMOS Status Overview & Configuration

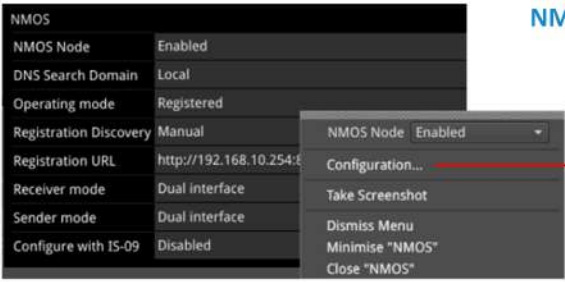

NMOS Status Overview & Options Menu

NMOS Node	Enabled
DNS Search Domain	Local
Operating mode	Registered
Registration Discovery	Manual
Registration URL	http://192.168.10.254:8019
Receiver mode	Dual interface
Sender mode	Dual interface
Configure with IS-09	Disabled



NMOS Configuration Dialog

Get config via IS-09: Disabled | DNS Search Domain: nmios.m

Registry discovery: Auto (DNS-SD) | Receiver mode: Single interface

Registry host / address: | Sender mode: Single interface

Registry port: | Use Custom NMOS Resource Prefix: Disabled

Registration API version: | NMOS Resource Prefix: |

Advertise NMOS control endpoints:

Mgmt port SFP E SFP F

NMOS Receivers Status Details

NMOS Receivers – SDP



NMOS Receivers – SDP (1/16 Screen Size)

Double-click to Expand/Contract



NMOS Receivers – SDP & Options Menu (1/4 Screen Size)

NMOS Senders Status Details

NMOS Senders – SDP

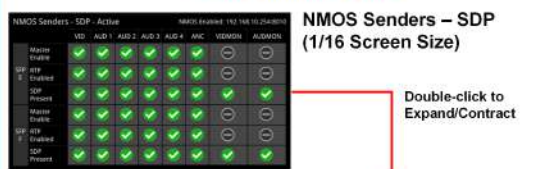

NMOS Senders – SDP (1/16 Screen Size)

Double-click to Expand/Contract



NMOS Senders – SDP & Options Menu (1/4 Screen Size)

NMOS Receivers – IS05

NMOS Receivers – IS05 (1/16 Screen Size)



NMOS Receivers – IS05 (1/16 Screen Size)

Double-click to Expand/Contract



NMOS Receivers – IS05 & Options Menu (1/4 Screen Size)

NMOS Senders – IS05

NMOS Senders – IS05 (1/16 Screen Size)

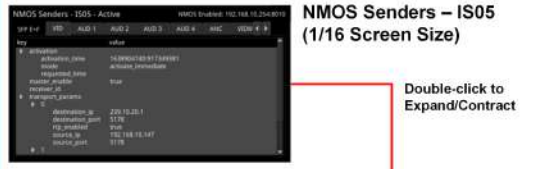

NMOS Senders – IS05 (1/16 Screen Size)

Double-click to Expand/Contract



NMOS Senders – IS05 & Options Menu (1/4 Screen Size)

Figure 4-14: An Overview of the NMOS Group of Instruments (ST 2110 IP Inputs)

Toggle Switches to Advertise NMOS Control Endpoints

The **Advertise NMOS control endpoints** toggle switches in the NMOS configuration dialog enable you to prevent network interfaces from being advertised in specific sections of the Node API resources, for details see the section: [Using the Advertise NMOS Control Endpoints Toggle Switches](#). This allows you to define how NMOS controllers connect to the unit by advertising the network addresses on which the unit listens for IS-04 and IS-05 requests.

For example, if an NMOS controller is connected only to the same network as the management port on the unit and cannot see the two networks to which the media interfaces on SFP E and SFP F are connected, you can disable NMOS control endpoint adverts on SFP E and SFP F using the toggle switches. If adverts from these endpoints are not disabled, the NMOS controller may try to make requests to unreachable networks.

Note: These controls have no effect on the availability of Sender, Receiver, Flow or Source resources with respect to the media interfaces nor do they affect which interfaces listen for NMOS requests. Even if an interface is prevented from advertising itself the interface continues to listen. Furthermore these controls have no effect on multicast or unicast DNS-SD service discovery.

Instrument Menu Options

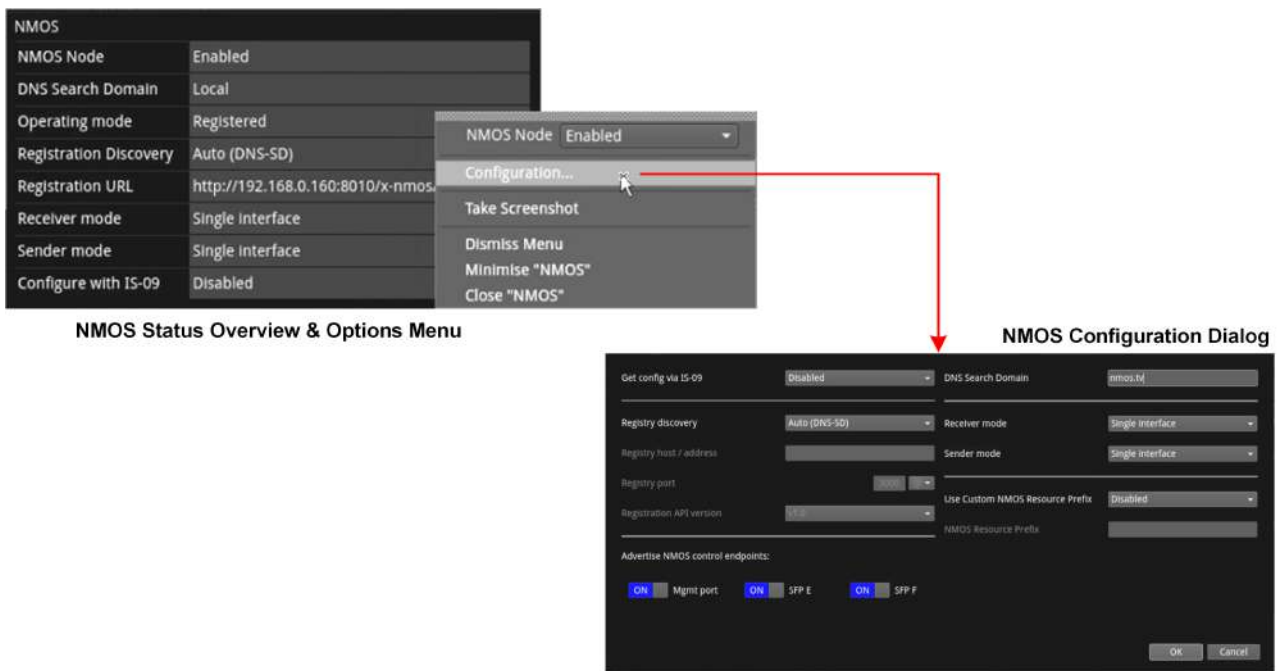

Figure 4-15: NMOS Instrument Options and Configuration Menu (ST 2110 IP Input)

The following table lists the configurable parameters in the NMOS instrument options menu:

Table 4-5 : NMOS Menu Options

Item	Options	Description
NMOS Node	Enabled Disabled (Default)	When enabled, allows the unit to act as an NMOS Node , and announce itself as a receiver or sender to the NMOS Registry. Note: If the interface changes (for example, it might be disconnected or taken down) the NMOS Node must be disabled and then re-enabled to re-establish the

Item	Options	Description
		connection.
Configuration....	N/A	Opens the Configuration dialog, see parameter details below.
Configuration Dialog Parameters		
Get config via IS-09	Enabled Disabled (Default)	Use NMOS IS-09 to obtain common global system parameters. When enabled, the unit will obtain the PTP domain from the IS-09 system source and apply to both SFP interfaces, if available.
DNS Search Domain	Blank (default) or free text entry field.	When left blank or set to the reserved mDNS domain (local.) the unit issues multicast DNS-SD (mDNS) requests. If you manually specify a domain different from local. using an external USB keyboard, you instruct the unit to use unicast DNS-SD requests.
Receiver mode	Dual interface Single Interface	This option enables you to select whether the unit registers itself as either an NMOS single or dual receiving interface. When single, each interface is displayed as a single entity in the NMOS Controller. When dual, the interfaces are displayed as a pair in the NMOS Controller. When prompted, confirm your change.
Sender mode	Dual interface Single Interface	This option enables you to select whether the unit registers itself as either an NMOS single or dual sending interface. When single, each interface is displayed as a single entity in the NMOS Controller. When dual, the interfaces are displayed as a pair in the NMOS Controller. When prompted, confirm your change.
Registry discovery	Auto (DNS-SD) (Default) Manual	Use either default, automated mDNS/DNS Service Discovery as defined by the DNS Search Domain entry to Identify the NMOS Registry, or enter the Registry details manually.
Registry host / address	Blank (default) or free text entry field.	Active only when Registry discovery set to Manual. Use the number pad to specify the IP address of the NMOS Registry.
Registry port	3000 (Default)	Active only when Registry discovery set to Manual. Use the number pad to specify the port number of the NMOS Registry.
Registration API version	v1.0 (Default) v1.1 v1.2 v1.3	Active only when Registry discovery set to Manual. Controls which version of the IS-04 API the NMOS node uses. Note: All API Versions will be displayed.
Use Custom NMOS Resource Prefix	Enabled Disabled (Default)	By default the NMOS Node Label is set to the unit's serial number e.g., qx-123456 . This is then used as part of the NMOS resource label e.g., qx-123456 SFP E VID 1 . When enabled, this control enables you to enter a different NMOS node label, if required, e.g., MCR QxL
NMOS Resource	Blank (default) or free text entry	Active only when Use Custom NMOS Resource

Item	Options	Description
Prefix	field.	Prefix enabled. Use a USB keyboard to enter a custom prefix NMOS device label for the NMOS resource name.
Advertise NMOS control endpoints		
Management Port (Mgmt Port)	ON (default) OFF	These toggle switches enable you to define how NMOS controllers connect to the unit by advertising the network addresses on which the unit listens for IS-04 and IS-05 requests. When switched ON, this setting makes the management port visible to the NMOS controller so that it can be used as the interface for NMOS requests from the unit. Switch OFF to prevent the management port from advertising its network address. For example, in the event that the management port is installed in a different network from the SFPs.
SFP E	ON (default) OFF	When switched ON, this setting makes SFP E visible to the NMOS controller so that it can be used as the interface for NMOS requests from the unit. Switch OFF to prevent SFP E from advertising its network address.
SFP F	ON (default) OFF	When switched ON, this setting makes SFP F visible to the NMOS controller so that it can be used as the interface for NMOS requests from the unit. Switch OFF to prevent SFP F from advertising its network address.

Note: If you are not using DHCP and are configuring the system by specifying the DNS Server manually, it is recommended do so in the **SFP IP Network** instrument, see [SFP IP Network](#).

NMOS Receivers - SDP

(ST 2110 IP Input)



Overview

The **NMOS Receivers - SDP** instrument displays either a summary status overview (1/16 screen size) or details of the current NMOS SDP file, defining the sender connectivity of the node (1/16 or 1/4 screen size).

The NMOS Receivers - SDP instrument toggles between displaying the statuses of the Master Enable, RTP Enables and SDP record, displaying the content of the active or staged Session Description Protocol (SDP) records.

Use this instrument to review the SDP file content or to save SDP files for offline analysis.

NMOS Receivers - SDP

As a component of an NMOS-enabled environment, the unit can register its presence with the NMOS Registry, for all flow types, as either a pair of single nodes, or as a dual receiver node.

This Instrument will display either one or two SDP records, depending on the configuration of the NMOS Receiver. If configured for an NMOS dual interface, SFP E and SFP F interfaces are treated as a pair and only one SDP record is displayed. When configured for NMOS single interfaces, then SFP E and SFP F are treated individually and the unit displays separate SDP records for each interface. For more information, see *IETF RFC 4566 SDP: Session Description Protocol* and SMPTE ST 2110-20, -30, -31 and -40.

At 1/16 screen size, you can switch the display between either a summary overview, showing the state of the Master and RTP Enables and the presence of a valid SDP record for each flow, or the details of the SDP file. The display adapts to show either one, two or four audio flows, depending on the number of flows configured in the [IP Receive - Flows](#) instrument.

In the summary overview, the unit displays the following information about the connection:

- **Master Enable:** Shows the status of either the active or staged NMOS Master Enable.
- **RTP Enabled:** (Single interface) Shows the status of either the Active or Staged NMOS RTP enable for each interface.
- **RTP 1 / RTP 2 Enabled:** (Dual interface) Shows the status of either the active or staged NMOS RTP Enable for each interface.
- **SDP Present:** Shows whether a validated SDP record is present.

At 1/16 screen size, switch between active and staged views, or the display of Summary or SDP details using the options menu.

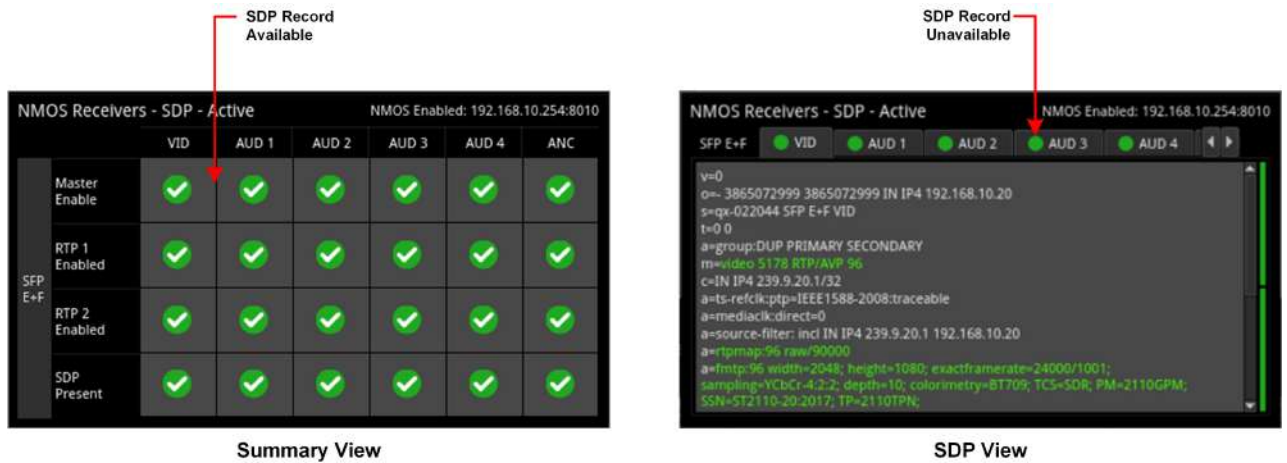

Figure 4-16: NMOS Receivers - SDP Instrument (Dual Interface, 1/16 Screen Size) (ST 2110 IP Input)

At 1/4 screen size, the instrument displays the full details of the SDP record.

You can switch between the active and staged data from the options menu and the unit displays the current selection (Active or Staged) in the instrument's title bar.

Once registered, you can use an NMOS Controller to manage the active connections with the unit. Use the tabs above the SDP panel(s) to monitor the active video, audio and ancillary SDP records, or to inspect the staged SDP files.

Note: The unit listens for NMOS communications on UDP Port 3000.

The choice of single/dual NMOS node is independent of the choice of 2022-7 SFP E, SFP F, or Seamless SFP E+F mode selection.

Note: In the event that the unit is unable to locate the NMOS Registry, it will revert to NMOS Peer to Peer mode and display **Peer to Peer** in place of the NMOS Registry IP address and port number in the title bar.

Any changes to connectivity made by the NMOS Controller are dynamically reflected in the NMOS Receivers - SDP Instrument.

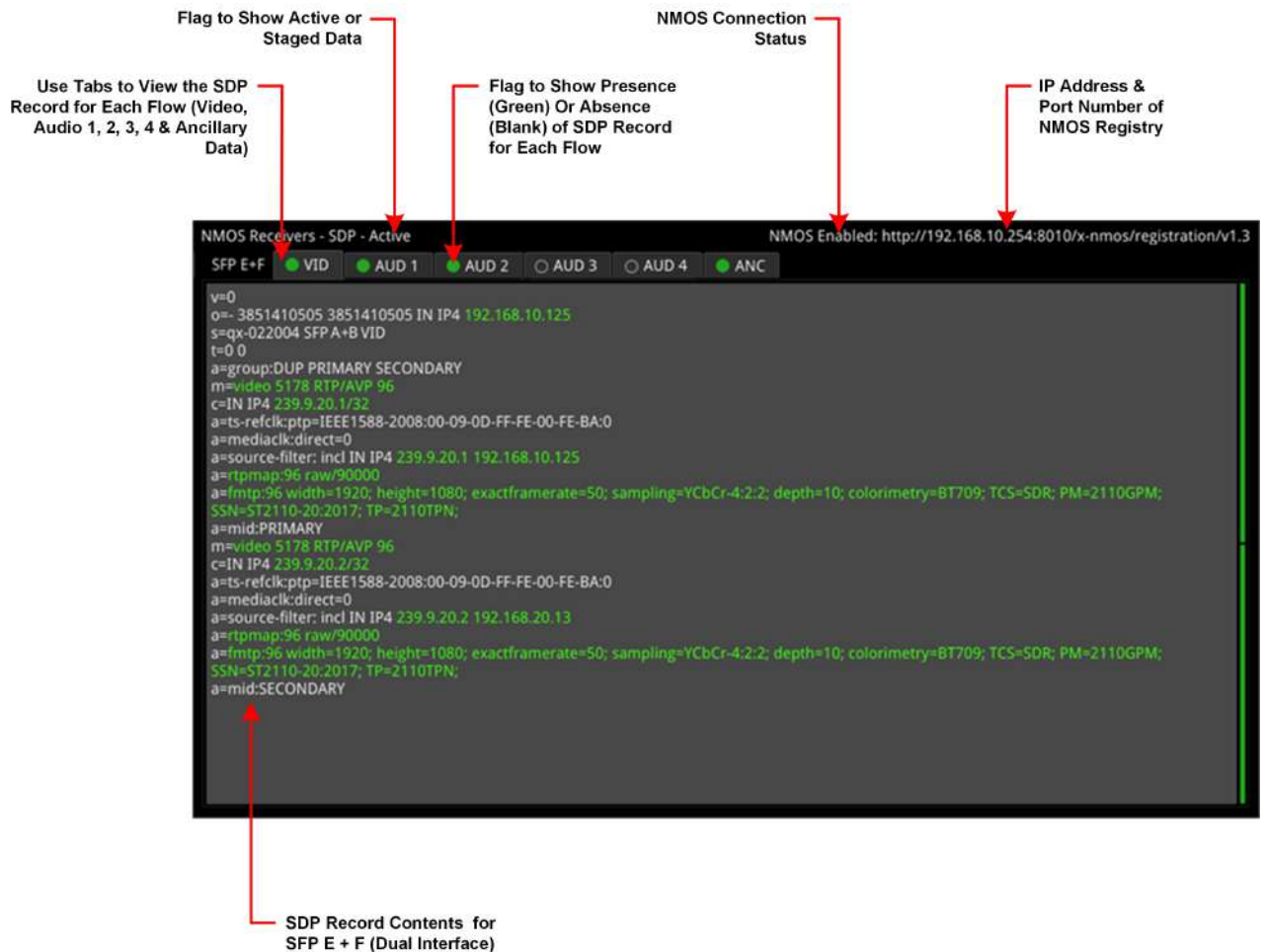

Figure 4-17: NMOS Receivers - SDP Instrument Views (Dual Interface, 1/4 Screen Size) (ST 2110 IP Input)

Saving SDP Records to Disk

You can save the active SDP records to disk as follows:

1. Open the Options menu and select Save Active SDPs.
The unit saves all active SDP records to a zip file.
2. Access the SDP records from the following folder:

From the File Manager:

qx:/log/sdp

Using SFTP:

/transfer/log/sdp

Instrument Menu Options

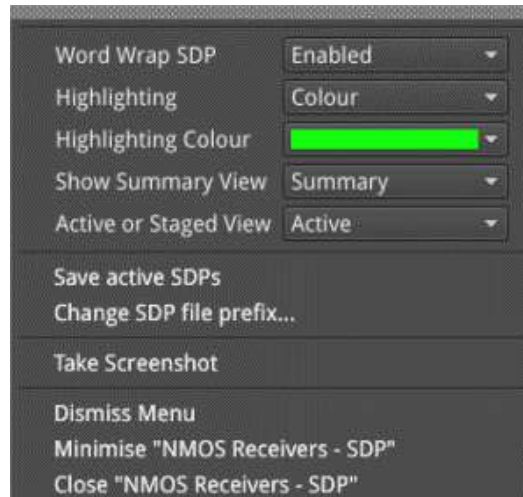

Figure 4-18: NMOS Receivers - SDP Instrument Menu Options

The following table lists the configurable parameters in the NMOS Receivers - SDP instrument options menu:

Table 4-6 : NMOS Receivers - SDP Menu Options

Item	Options	Description
Word Wrap SDP	Enabled (Default) Disabled	When enabled, uses word wrap to display the full SDP text descriptions in the available width of the display window. When disabled, you will need to use the horizontal scroll bar(s) to read long SDP descriptions.
Highlighting	None (Default) Monochrome Color	Select Color to open the color palette from which you can select the most appropriate color in which to highlight those SDP data parameters most pertinent to the unit's setup, for example, the source and destination IP addresses, video and audio setup parameters, etc. Select Monochrome to highlight in gray those SDP data parameters, most pertinent to the unit's setup. You can save the highlighting option and any selected color in the presets.
Highlighting Color	Select from color palette.	Choose a highlight color from the color palette in which to display SDP data parameters.
Show Summary View	Summary (Default) SDP	Switch between the overview summary and the SDP detail. This option is available only at 1/16 screen size.
Active or Staged View	Active (Default) Staged	This option enables you to switch between the active SDP file and the staged file.
Save Active SDPs	N/A Active Control	Save the active, validated SDP file to the unit's storage. The instrument saves files with a .sdp extension.
Change SDP file prefix...	ActiveReceiverSdp (Default) Or enter an alternative filename using the onscreen keyboard or a connected USB keyboard.	Change the default file prefix if saving multiple SDP files to prevent overwriting of the last saved file.

NMOS Receivers - IS05 (ST 2110 IP Input)



Overview

AMWA IS-05 Device Connection Management specifies how to allow a device in an NMOS-compatible system to connect to other devices.

The **NMOS Receivers - IS05** instrument displays a convenient view of the IS-05 parameters as seen by the NMOS node for each flow.

NMOS Receivers - IS05

The NMOS Receivers - IS05 instrument provides additional detail about the NMOS connection to supplement the information in the Session Description Protocol (SDP) record. This instrument displays the current NMOS IS-05 parameters, defining the receiver connectivity of the node. The instrument presents the IS-05 data in either a tree format (shown below), with expandable or collapsible sections, or as a raw text string. You can switch between the active and staged data from the options menu and the unit displays the current selection (Active or Staged) in the instrument's title bar. The display adapts to show tabs for either one, two or four audio flows, depending on the number of flows configured in the [IP Receive - Flows](#) instrument.

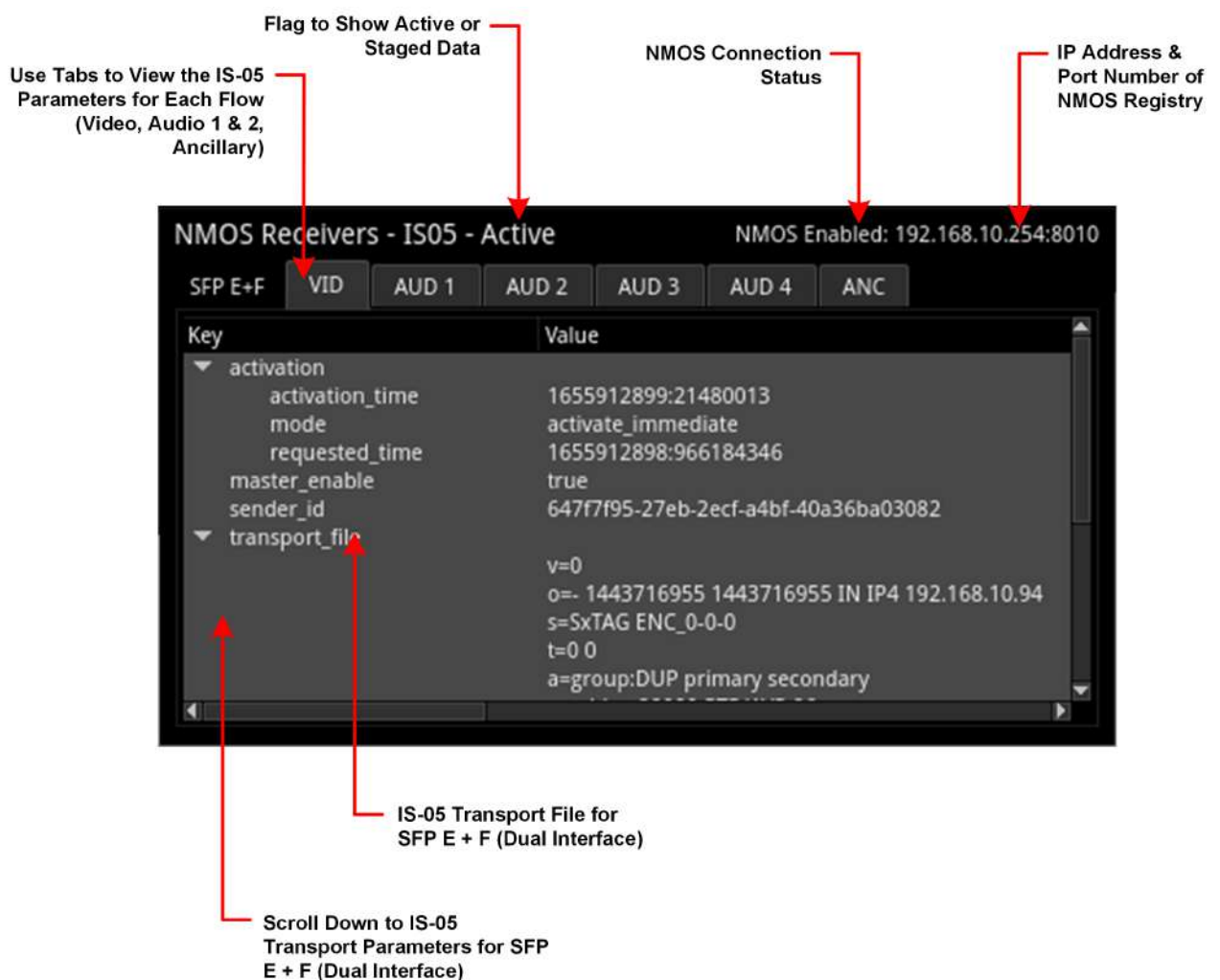

Figure 4-19: NMOS Receivers - IS05 Instrument (Dual Interface, 1/16 Screen Size) (ST 2110 IP Input)

The NMOS Receivers - IS05 instrument displays either one or two sets of IS-05 parameters, depending on how the NMOS Receiver is configured. If the unit is configured for an NMOS dual interface, SFP E and SFP F interfaces are treated as a pair, and only one IS-05 parameter set is displayed. If the unit is configured for NMOS single interfaces, then SFP E and SFP F are treated individually and the unit displays separate IS-05 parameter sets for each interface.

Each interface (either single or dual) provides tabs to switch between the possible flows (VID, AUD 1 to AUD 4 (configurable) and ANC) enabling you to view the IS-05 parameters for each flow. You can choose to display the instrument in 1/16 screen size or, for improved viewing of data, at 1/4 screen size.

For more information on the **NMOS Receivers - SDP** instrument, see [NMOS Receivers - SDP \(ST 2110 IP Input\)](#).

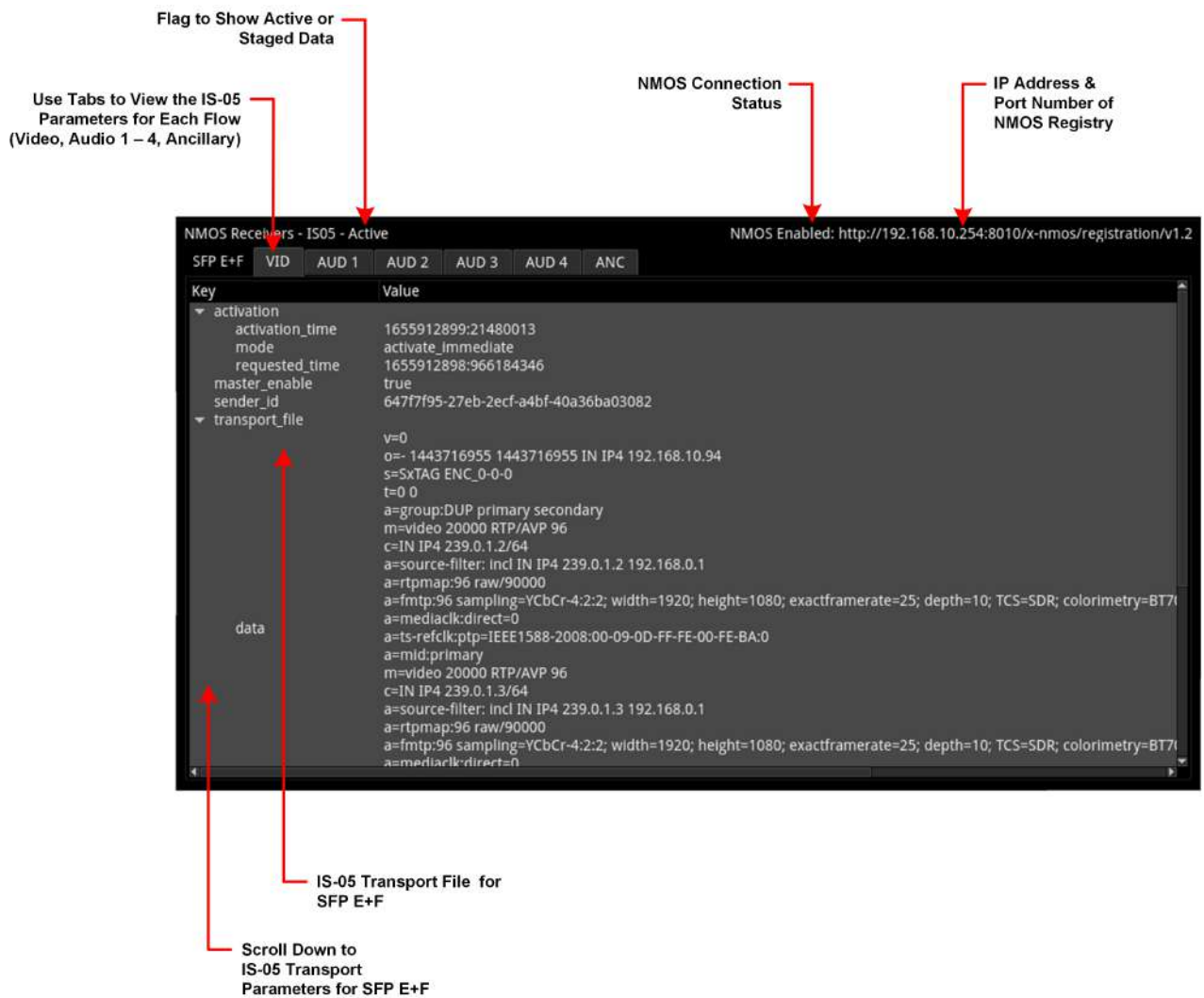

Figure 4-20: NMOS Receivers - IS05 Instrument - Expanded to 1/4 Screen Size (Dual Interface) (ST 2110 IP Input)

Instrument Menu Options

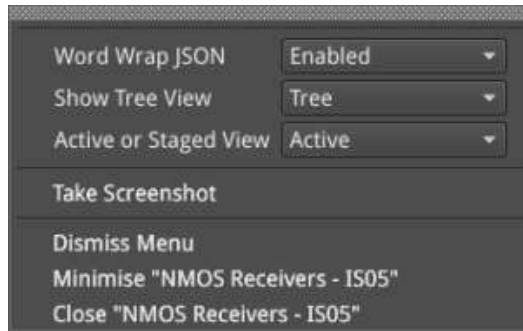

Figure 4-21: NMOS Receivers - IS05 Instrument Menu Options

The following table lists the configurable parameters in the NMOS Receivers - IS05 instrument options menu:

Table 4-7 : NMOS Receivers - IS05 Menu Options

Item	Options	Description
Word Wrap JSON	Enabled (Default) Disabled	When enabled, wraps the raw text string containing the IS-05 parameters to the displayed screen width.
Show Tree View	Tree (Default) Raw	When enabled, displays the NMOS IS-05 parameters in an interactive tree format.
Active or Staged View	Active (Default) Staged	This option enables you to switch between the active and the staged IS-05 parameters.

NMOS Senders - SDP

(ST 2110 IP Inputs)



Overview

The **NMOS Senders - SDP** Instrument displays the content of the active Session Description Protocol (SDP). Use this instrument to review the SDP file content or save active SDP records for offline analysis. The NMOS sender is activated automatically when the 2110 Generator is available.

NMOS Senders - SDP

As a component of an NMOS-enabled environment, the unit can register its presence, for all flow types, as either a pair of single nodes, or as a dual sender node,.

This Instrument will display either one or two SDP records, depending on the configuration of the NMOS Sender. If configured for an NMOS dual interface, SFP E and SFP F interfaces are treated as a pair and only one SDP record is displayed. When configured for NMOS single interfaces, then SFP E and SFP F are treated individually and the unit displays separate SDP records for each interface. For more information, see *IETF RFC 4566 SDP: Session Description Protocol* and SMPTE ST 2110-20, -30, -31 and -40.

The NMOS Senders - SDP instrument displays either a summary status overview (1/16 and 1/4 size) or details of the current NMOS SDP file, defining the sender connectivity of the node (full screen size).

At 1/16 and 1/4 screen size, you can switch the display between either a summary overview, showing the active SDP connections for each flow, or the details of the SDP record. In the summary overview, the unit displays the following information about the connection:

- **Master Enable:** Shows the status of the active NMOS Master Enable.
- **RTP Enabled:** (Single interface) Shows the status of the active NMOS RTP enable for each interface.
- **RTP 1 / RTP 2 Enabled:** (Dual interface) Shows the status of the active NMOS RTP Enable for each interface.
- **SDP Present:** Shows whether an SDP record is present.

Switch between the display of Summary or SDP in 1/16 or 1/4 screen size, using the options menu.

Note: As the Sender SDP record is created dynamically when the flow is activated (Active view), a Staged Sender SDP record does not exist.

An NMOS Receiver, however, may have both Active and Staged SDP records.

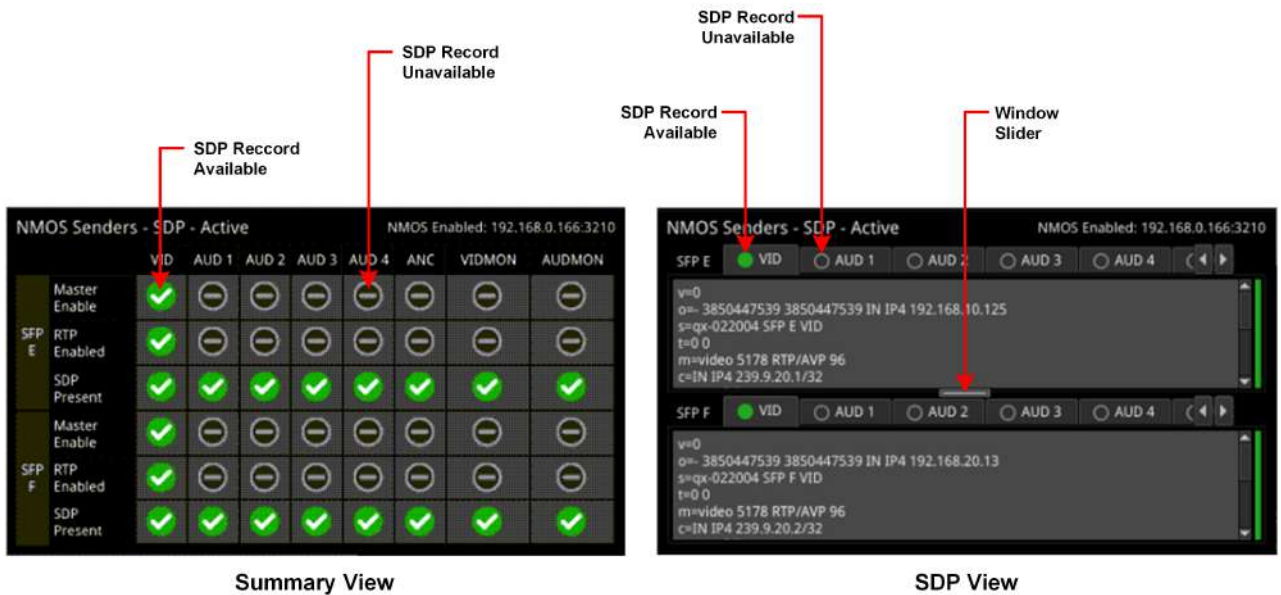

Figure 4-22: NMOS Senders - SDP Instrument (Single Interface, 1/16 Screen Size) (ST 2110 IP Inputs)

At full screen size, the instrument displays the complete details of the active SDP record.

Once registered, you can use an NMOS Controller to manage the active connections with the unit. Use the tabs above the SDP panel(s) to monitor the active video, audio, ancillary, VIDMON and AUDMON SDP records.

Note: The unit listens for NMOS communications on UDP Port 3000.

The choice of single/dual NMOS node is independent of the choice of 2022-7 SFP E, SFP F, or Seamless SFP E+F mode selection.

Note: In the event that the unit is unable to locate the NMOS Registry, it will revert to NMOS Peer to Peer mode and display **Peer to Peer** in place of the NMOS Registry IP address and port number in the title bar.

Any changes to connectivity made by the NMOS Controller are dynamically reflected in the NMOS Senders - SDP instrument.

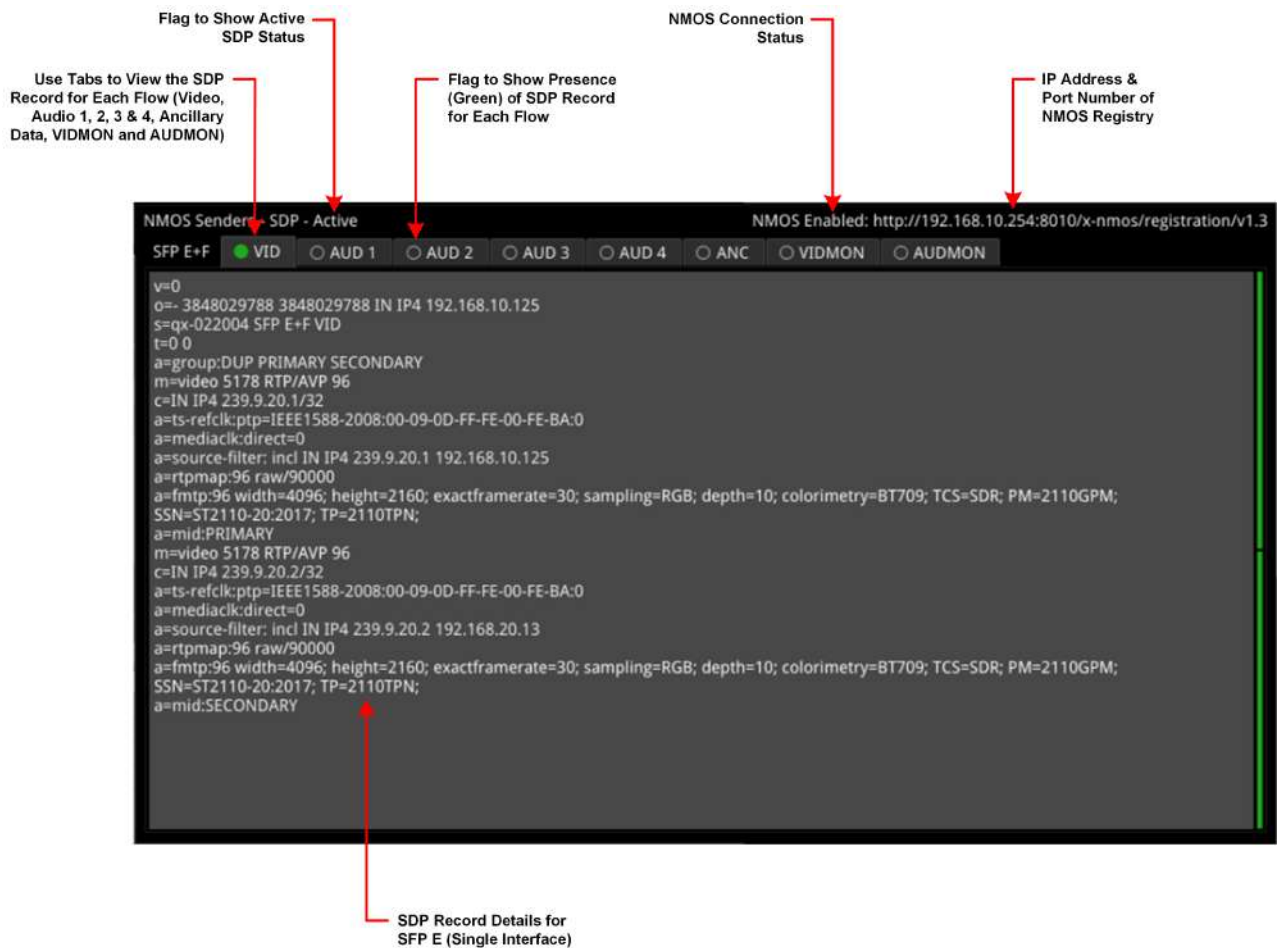

Figure 4-23: NMOS Senders - SDP Instrument View (Dual Interface, 1/4 Screen Size) (ST 2110 IP Inputs)

Saving SDP Records to Disk

You can save the active SDP records to disk as follows:

1. Open the Options menu and select Save Active SDPs.
The unit saves all active SDP records to a zip file.
2. Access the SDP records from the following folder:

From the File Manager:

qx:/log/sdp

Using SFTP:

/transfer/log/sdp

Instrument Menu Options

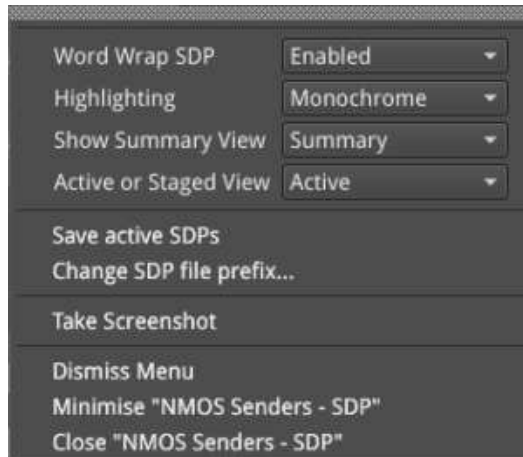

Figure 4-24: NMOS Senders - SDP Instrument Menu Options

The following table lists the configurable parameters in the NMOS Senders - SDP instrument options menu:

Table 4-8 : NMOS Senders - SDP Menu Options

Item	Options	Description
Word Wrap SDP	Enabled (Default) Disabled	When enabled, uses word wrap to display the full SDP text descriptions in the available width of the display window. When disabled, you will need to use the horizontal scroll bar(s) to read long SDP descriptions.
Highlighting	None (Default) Monochrome Color	Select Color to open the color palette from which you can select the most appropriate color in which to highlight those SDP data parameters, most pertinent to the unit's setup, for example, the source and destination IP addresses, video and audio setup parameters, etc. Select Monochrome to highlight in gray those SDP data parameters, most pertinent to the unit's setup. You can save the highlighting option and any selected color in the presets.
Highlighting Color	Select from color palette.	Choose a highlight color from the color palette in which to display SDP data parameters.
Show Summary View	Summary (Default) SDP	Switch between the overview summary and the SDP detail. This option is available only at 1/16 screen size.
Save Active SDPs	N/A Active Control	Save active SDP records to the unit's storage. The instrument saves files with a .sdp extension.
Change SDP file prefix...	ActiveSenderSdp (Default) Or enter an alternative filename using the onscreen keyboard or a connected USB keyboard.	Change the default file prefix if saving multiple SDP records to prevent overwriting of the last saved file.

NMOS Senders - IS05 (ST 2110 IP Inputs)



Overview

AMWA IS-05 Device Connection Management specifies how to allow a Device in an NMOS compatible system to connect to other Devices.

The **NMOS Senders - IS05** instrument displays a convenient view of the IS-05 parameters as seen by the QxL NMOS node for each flow.

NMOS Senders - IS05

The NMOS Senders - IS05 instrument provides additional detail about the NMOS connection to supplement the information in the Session Description Protocol (SDP) record. This instrument displays the current NMOS IS-05 parameters, defining the sender connectivity of the node. The instrument presents the IS-05 data in either a tree format (shown below), with expandable or collapsible sections, or as a raw text string. You can switch between the active and staged data from the options menu and the unit displays the current selection (Active or Staged) in the instrument's title bar.

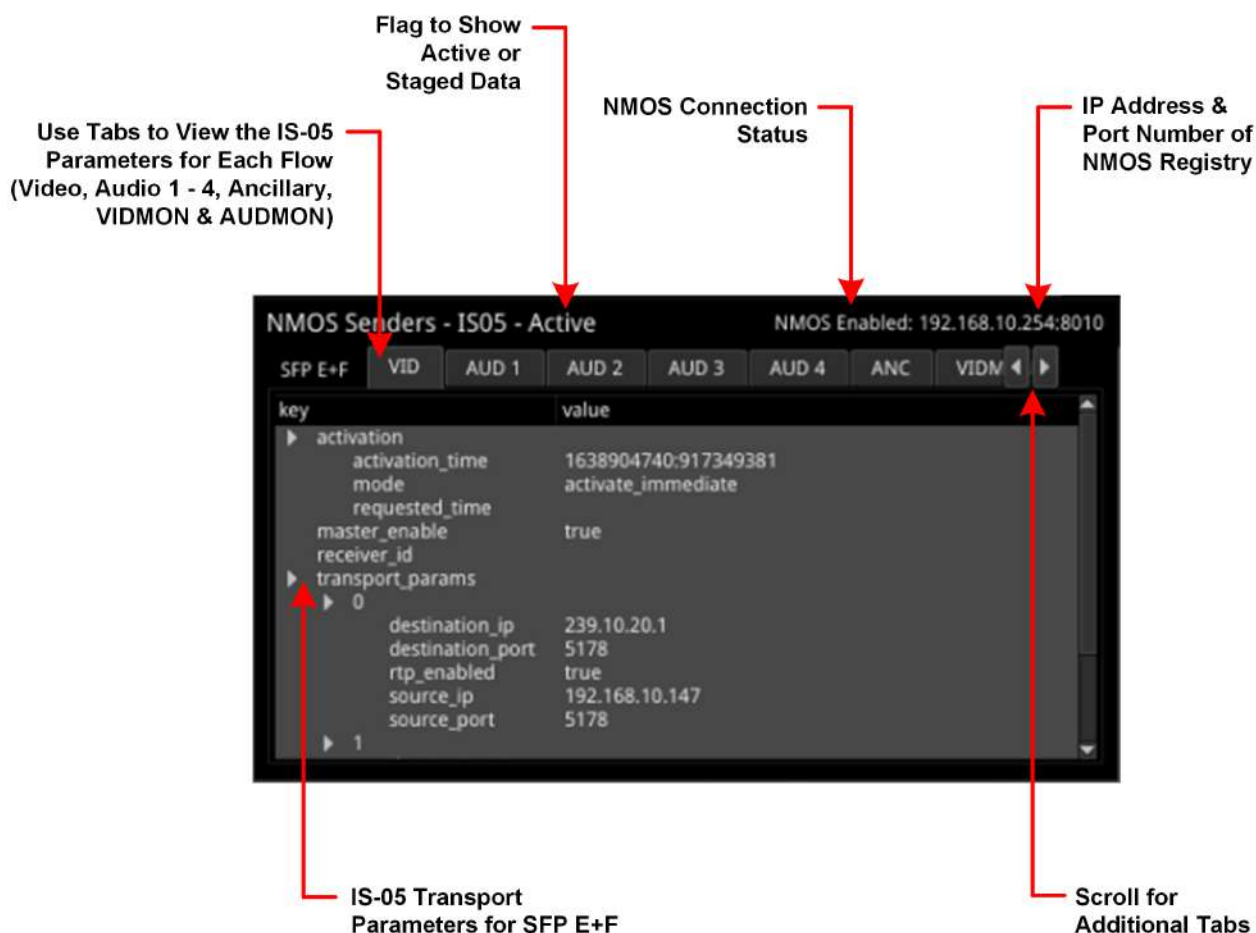

Figure 4-25: NMOS Senders - IS05 Instrument (Dual Interface, 1/16 Screen Size) (ST 2110 IP Inputs)

The NMOS Senders - IS05 instrument displays either one or two sets of IS-05 parameters, depending on how the NMOS Sender is configured. If the unit is configured for an NMOS dual interface, SFP E and SFP F interfaces are treated as a pair, and only one IS-05 parameter set is displayed. If the unit is configured for NMOS single interfaces, then SFP E and SFP F are treated individually and the unit displays separate IS-05 parameter sets for each interface.

Each interface (either single or dual) provides tabs to switch between the possible flows (VID, AUD1 to AUD4, ANC, VIDMON and AUDMON) enabling you to view the IS-05 data for each flow. You can choose to display the instrument in 1/16 screen size or, for improved viewing of data, at 1/4 screen size.

For more information on the **NMOS Senders - SDP** instrument, see [NMOS Senders - SDP \(IP 2110 Mode\)](#).

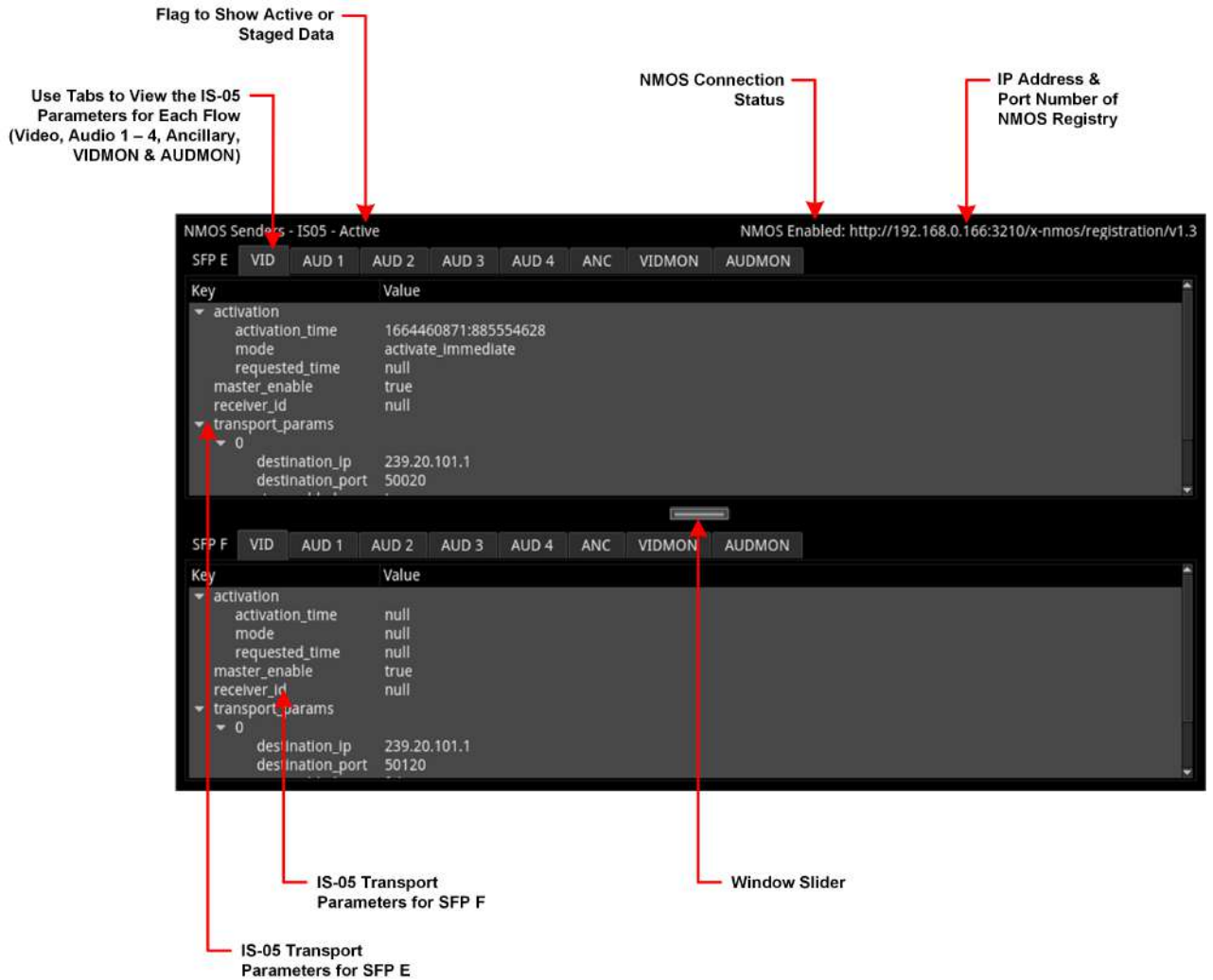

Figure 4-26: NMOS Senders - IS05 Instrument - Expanded to 1/4 Screen Size (Single Interface) (ST 2110 IP Inputs)

Instrument Menu Options

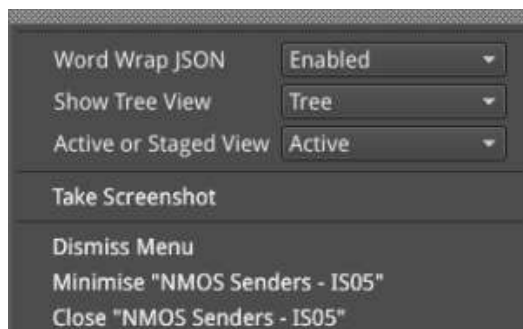

Figure 4-27: NMOS Senders - IS05 Instrument Menu Options

The following table lists the configurable parameters in the NMOS Senders - IS05 instrument options menu:

Table 4-9 : NMOS Senders - IS05 Menu Options

Item	Options	Description
Word Wrap JSON	Enabled (Default) Disabled	When enabled, wraps the raw text string containing the IS-05 parameters to the displayed screen width.
Show Tree View	Tree (Default) Raw	When enabled, displays the NMOS IS-05 parameters in an interactive tree format.
Active or Staged View	Active (Default) Staged	This option enables you to switch between the active and the staged IS-05 parameters.

SFP E/F - PTP Info (ST 2110 IP Input)



Overview

The unit supports SMPTE protocol ST 2059 Precision Time Protocol for the synchronization of media across an IP network. You can choose to receive either a single active PTP reference feed or dual PTP reference feeds into both SFPs, with one being the active system reference and the other a standby system reference.

If using dual PTP feeds, you can display a **SFP E/F - PTP Info** instrument for each SFP.

You can select the system reference in the **Video Timing & System Reference** Instrument. Use the **System Reference** dropdown list to select either PTP SFP E, PTP SFP F or Free Run.

The selection of IGMP Max Version in the **SFP IP Network** instrument affects all IGMP requests, including PTP and Media Flows requested in the **IP Receive - Flows** Instrument.

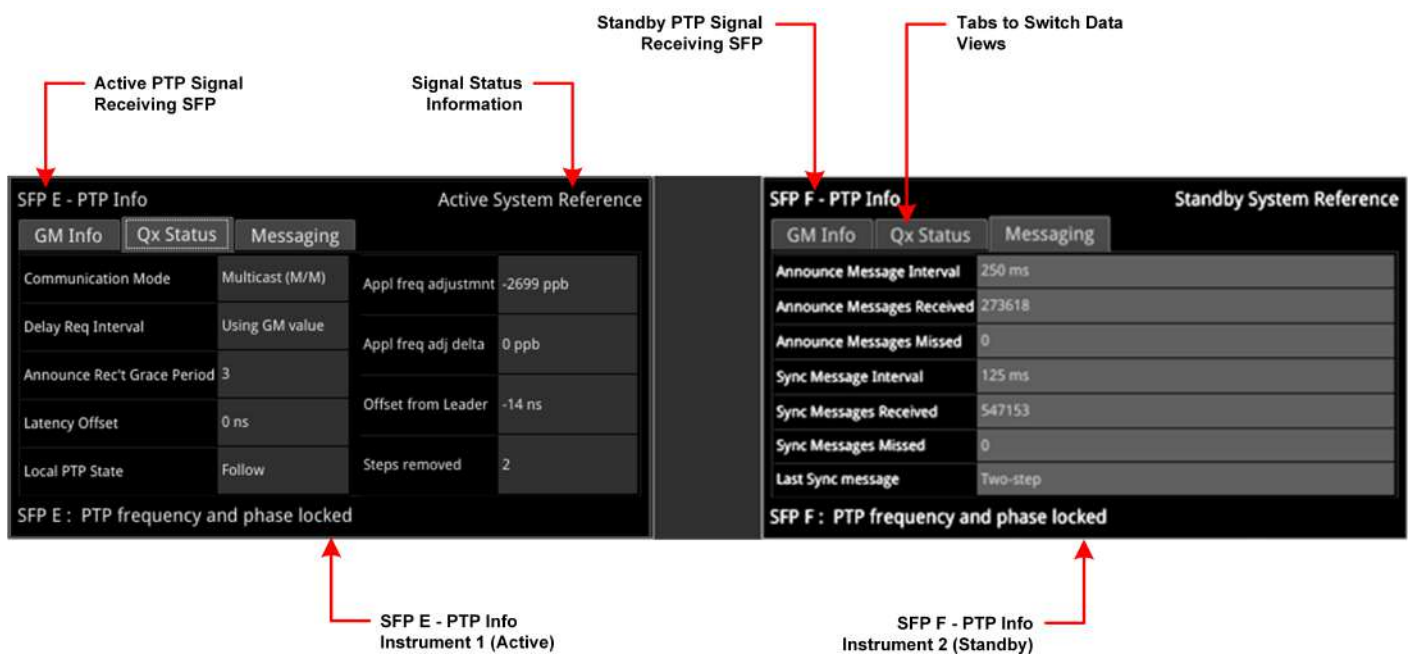

Figure 4-28: Dual SFP E and F - PTP Info Instruments (ST 2110 IP Input)

The SFP E/F - PTP Info Instrument features include:

- Control of the PTP Grandmaster (GM) domain and communication mode (Multicast (Multicast/Multicast) or SMPTE Mixed without negotiation (Multicast/Unicast))
- Indication of PTP lock status
- GM information including Master ID and Best Master Clock Algorithm (BMCA) parameters
- Indication of estimated frequency and phase lock offset
- Indication of one-step or two-step sync traffic.

The PTP Info status information at the bottom of the window indicates the SFP currently in use and the state of the PTP lock, which you can interpret using the information in the following table:

Table 4-10 : PTP Information Status Messages

PTP Info Status Message	PTP Info Status Color	PTP Lock State
Listening	Red	The PTP Follower is listening on the selected domain number, but has not acquired a PTP Leader or PTP Delay Request information.
Frequency locked	Yellow	The PTP Follower has acquired a PTP Leader and has achieved frequency lock. The Estimated Phase offset is greater than 2 μ s.
Frequency and phase locked	White	The PTP Follower is frequency locked and the estimated phase offset is less than 2 μ s.
In holdover	Yellow	The PTP Follower had acquired lock, but has now lost the PTP Leader and is in frequency holdover.
Recovered from holdover	Yellow	The PTP Follower has recovered from a holdover condition where the GM was lost but subsequently re-acquired.

The **Clear Warnings** button in the Instrument submenu enables you to remove any yellow warning messages that may be displayed following changes to the PTP lock.

The **SFP E/F - PTP Info** Instrument provides detailed information about the PTP reference signal in the following three tabs:

- **GM Info:** Provides information about the PTP Grandmaster clock to which the system is locked on SFP E and / or SFP F.
- **Qx Status:** Provides information about the configuration, operating mode and status of the unit with respect to the PTP reference signal, together with an indication of the quality of the lock to PTP.
- **Messaging:** Provides information about the timing and number of Announce and Sync PTP messages received from the Grandmaster.

The content of each tab in the SFP E/F - PTP Info Instrument is described in the following sections:

GM Info Tab

The **GM Info** tab reports the following data elements relating to the PTP clock signal received from the Grandmaster:

Table 4-11 : Grandmaster Information (GM Info) Tab

Data Element	Description
Domain	The domain number of the current synchronization domain, in the range 0 (default) to 127.
Leader ID	Identity attribute of the Grandmaster clock.
Priority 1	The Priority 1 attribute of the Grandmaster clock in the range 0 to 255 with the lower value having the highest priority.
Priority 2	The Priority 2 attribute of the Grandmaster clock in the range 0 to 255 with the lower value having the highest priority.
Clock Class	The traceability of the time or frequency distributed by the clock, provided as a numerical value identifying the clock state.
Clock Accuracy	Indicates the expected accuracy of the clock. For example: < 250 ns

Data Element	Description
Variance	Provides an indication of the quality of the Grandmaster Clock.
Clock Source	The source of time used by the Grandmaster clock, for example, GPS.
PTP Time	Actual PTP time received from the Grandmaster to which the unit is aligned. For example: 2020-09-16 11:00:00 (UTC)

Qx Status Tab

The **Qx Status** tab reports the following data elements relating to the current PTP status of the unit:

Table 4-12 : Qx Status Data Tab

Data Element	Description
Communication Mode	Current setting of the unit. For more information, or to change the setting, see the section Instrument Menu Options .
Delay Req Interval	Current setting of the unit. For more information, or to change the setting, see the section Instrument Menu Options .
Announce Rec't Grace Period	Current setting of the unit. For more information, or to change the setting, see the section Instrument Menu Options .
Latency Offset	Current setting of the unit. For more information, or to change the setting, see the section Instrument Menu Options .
Local PTP State	Current status of the unit with respect to the PTP signal, for example, Listening.
Appl Freq Adjustmnt	The Applied Frequency Adjustment is the adjustment, in parts per billion, made to the unit's clock to make it frequency-locked to the clock of the Grandmaster, that is, both clocks are at the same frequency but not necessarily at the same phase. This value is calculated in software.
Appl Freq Adj Delta	The Applied Frequency Adjustment Delta is the change (delta) to the Applied Frequency Adjustment in the last second. When in lock, this will typically be 0 or 1 part per billion. This value is calculated in software.
Offset from Leader	The estimated phase offset between the Grandmaster clock and the local follower clock, for example, - 200 ns.
Steps Removed	The number of IP hops between the Grandmaster and the local follower clock. If the unit were connected directly to the GM, the value would be 1.

PTP Messaging Tab

The **Messaging** tab reports the following data elements relating to the receipt of Announce and Sync messages from the Grandmaster:

Table 4-13 : Messaging Data Tab

Data Element	Description
Announce Message Interval	The Grandmaster sends out Announce messages to provide listening nodes with information about the sending clock. The Announce Message Interval is the time between consecutive Announce messages. This value is signaled by the GM and reported by the unit.
Announce Messages Received	The number of Announce messages received from the Grandmaster to which the unit is locked.
Announce Messages Missed	The number of Announce messages sent from the Grandmaster that were not received by the unit.

Data Element	Description
Sync Message Interval	The Grandmaster sends out Sync messages, which it uses to calculate the offset from the Master and to make adjustments. This value is signaled by the GM and reported by the unit.
Sync Messages Received	The number of Sync messages received from the Grandmaster to which the unit is locked.
Sync Messages Missed	The number of Sync messages sent from the Grandmaster that were not received by the unit.
Last Sync Message	The state of the two-step flag in the last sync message indicating one-step or two-step. A two-step flag indicates that there is a follow-up message containing the time-stamp, whereas a one-step flag indicates that the time-stamp is included as part of the Sync Message.

Instrument Menu Options

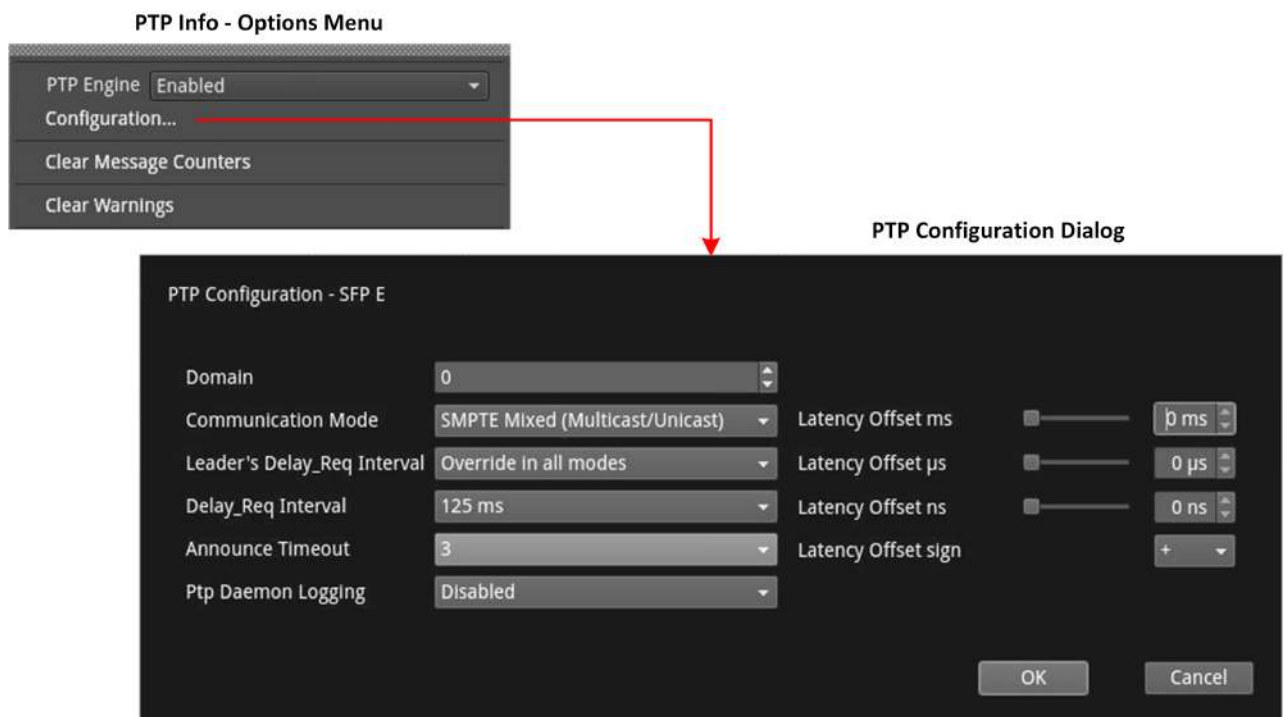

Figure 4-29: SFP E/F - PTP Info Instrument Menu Options

The following table lists the configurable parameters in the SFP E/F - PTP Info instrument submenu:

Table 4-14 : SFP E/F - PTP Info Menu Options

Item	Options	Description
PTP Main Menu		
PTP Engine	Enabled (Default) Disabled	When disabled, switches off the PTP engine on the corresponding SFP to stop listening to PTP messages on that interface. You can select which SFP to use as the current, active PTP engine using the System Reference dropdown in the options menu of the Video Timing & System Reference instrument.
Configuration...	System Control	Opens PTP Configuration dialog. See below.
Clear Message Counters	System Control	Resets all message counters to zero, for example, resets the counters Announce Messages Received and Sync Messages Received.
Clear Warnings	System Control	Removes warning messages from the status line at the bottom of the Instrument window.
PTP Configuration Dialog		
Domain	0 (default) to 127	Defines the IP domain in which the PTP GM is located.
Communication Mode	Multicast (Multicast/Multicast) SMPTE Mixed (Multicast/Unicast)	The unit supports two PTP communication modes: <ul style="list-style-type: none"> • Multicast mode (Multicast Announce and Sync, Multicast Delay Request, Delay Response) • SMPTE Mixed mode without negotiation (Multicast Announce and Sync, Unicast Delay Request, Delay Response) In Multicast mode, you can set the unit automatically to adopt the Leader Sync message rate for its multicast Delay Request message rate, by setting the unit's Leader's Delay_Req interval option to Do not override in Multicast mode . Alternatively, you can set the Delay Request message rate to manual control by setting the unit's Leader's Delay_Req interval option to Override in all modes . In SMPTE Mixed mode the Delay Request message rate is always under manual control.
Leader's Delay_Req Interval	Do not override in Multicast Mode (Default) Override in all modes	In Multicast Mode, the default Delay_Req interval is set to be the same as the Leader Sync message interval.
Delay_Req Interval	7.8125 ms, 15.625 ms, 31.25 ms, 62.5 ms, 125 ms (Default), 250 ms, 500 ms, 1 s, 2 s, 4 s, 8 s, 16 s, 32 s	Allows you manually to define a Delay Request (Delay_Req) message interval, that is, the rate at which Delay_Req messages are sent. When you set the Communication mode to SMPTE Mixed or Multicast (MM) and enable Override in all modes, this is the rate at which the unit sends Delay_request messages back to the Grandmaster.
AnnounceTimeout	2 - 10 (× Announce Timeout) Default: 3 × Announce Timeout	A Grandmaster transmits a PTP Announce Message to indicate its presence on the network. Accompanying this

Item	Options	Description
		message is the signaled Announce Message Rate and the Announce Timeout Count. A PTP follower, such as this unit, uses this information to confirm that the Master is still present and active. If the unit experiences a set of missing Announce messages greater than the Announce Timeout Count, then it will assume that the PTP Master is missing and will attempt to re-lock. The time for this count to trigger is the Announce Timeout . This is a user-definable delay that is equal to the selected value multiplied by the Announce Timeout. The delay period allows for a seamless Grandmaster change-over before the unit attempts to re-acquire PTP lock. The default setting is three times the Announce Receipt timeout but you can choose between two to ten times the Announce Receipt timeout interval.
Ptp Daemon Logging	Disabled (Default) Enabled	Customer support feature, disabled by default. Do not enable this option unless specifically requested to do so by PHABRIX Support to assist troubleshooting.
Latency Offset sign	+ -	Sets the Latency Offset as an increase (positive (+) value) or decrease (negative (-) value.)
Latency Offset (ms, μ s, ns scales)	User Defined	The long term PTP phase alignment of the unit can be affected by network delay asymmetries or, for example, by conversion between a 1 G PTP source and a 25 G network. You can adjust this long-term PTP phase offset by comparing the 1 PPS from the unit on the GPI output with the 1 PPS from the PTP Grandmaster on an oscilloscope. You can then adjust the unit's PTP Latency Offset control sliders accordingly to bring the unit's 1 PPS into time alignment with the 1 PPS of the Grandmaster. The value of the PTP Latency offset is reported in the Qx Status tab of the PTP Info instrument.
Ok	System Control	Applies any PTP configuration changes after updating the PTP settings.

The Delay Request message rate options are as follows:

Table 4-15 : Options for the Delay Request Message Rate

Delay_Req Interval	Delay Request Messages/Second
7.8125 ms	125
15.625 ms	62.5
31.25 ms	31.25
62.5 ms	15.625
125 ms	8
250 ms	4
500 ms	2
1 s	1
2 s	0.5
4 s	0.25
8 s	0.125
16 s	0.0625
32 s	0.03125

Video Timing & System Reference (IP Input)



Overview

The **Video Timing & System Reference** Instrument provides measurements that enable you to assess the timing quality of the input relative to a selected reference. If necessary, you can then set timing offsets against which to measure. The measurements and adjustment tools available depend on whether the inputs are received from an ST 2022-6 or ST 2110 IP source, as summarized in the following table.

Table 4-16 : Overview of IP Video Timing Functions by License and Analyzer Input

	Analyzer Input	
	ST 2022-6 IP Input	ST 2110 IP Input
Standard PHQXL License	Decaps vs Sys Ref 	Media Latency Tab (Mean Data Column)
		Ext Ref vs PTP
PHQXLO -IP-MEAS License	Decaps vs Sys Ref 	Video Timing Tab (Full Data)
		Media Latency Tab (Full Data)

Timing of ST 2022-6 IP Input: Decapsulated vs System Reference

For ST 2022-6 input, the **Video Timing & System Reference** instrument window compares the timing of the decapsulated input against a selected System Reference to which the unit is locked. You can select the system reference from either External or Free Run reference signals. The instrument displays the following resulting measurements in both spatial units (lines and pixels) and time (μs or ns):

- Measured Timing
- Offset to Apply (with External Reference only)
- Offset Timing (with External Reference only).

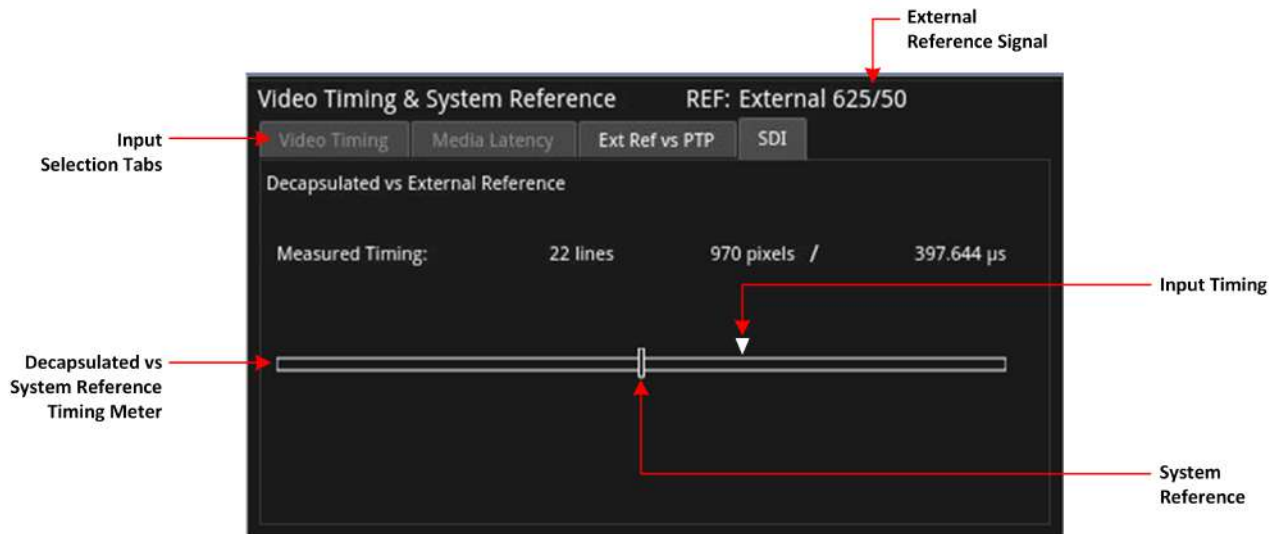

Figure 4-30: Video Timing & System Reference Instrument (ST 2022-6 IP Input)

A timing meter dynamically measures the timing of the input (white triangle) against the System Reference (centrally fixed, black vertical rectangle). In addition to measuring the input against an absolute system reference, you can choose to apply a system reference offset against which to measure. The position of any offset is shown on the timing bar as a black triangle.

Video Timing for ST 2110 IP Input

Overview

For an ST 2110 IP input, the **Video Timing & System Reference** instrument must be stably locked to the same PTP source as the sending device. The **Video Timing & System Reference** window includes the following tabs, each providing access to different timing data for ST 2110 IP input:

- External Reference vs PTP
- Media Latency

External Reference vs PTP Tab

The **Ext Ref vs PTP** tab is a timing tool for use in a hybrid system to compare the external analog reference with the PTP reference. Use the options menu to set the **System Reference** to either **PTP SFP E** or **PTP SFP F** and the PTP lock must be stable with a low PTP Estimated Phase Offset for this measurement to be valid.

The instrument displays the time difference between the external analog reference and PTP both in units of video lines and pixels, and units of time (μs or ms .)

The accuracy of this measurement depends on the long-term PTP phase alignment of the unit, which can be affected by network delay asymmetries or by conversion between a 1G PTP source and a 10G or 25G network.

You can adjust this long-term PTP phase offset by comparing the 1PPS from the unit on the GPIO with the 1PPS from the PTP Grandmaster using an oscilloscope. In addition, you can adjust the unit's PTP Latency Offset controls in the options menu of the **PTP Info** Instrument to bring the 1PPS of the unit into time alignment with the 1PPS of the Grandmaster.

The **Ext Ref vs PTP** tab displays any offset between an external reference signal and the PTP reference. It shows this value in units of time as well as in lines and pixels. If the external reference originates from the same source as PTP then the value displayed should represent the phase offset of the unit. Use this tool to show how well your external reference is locked to PTP. If it is not locked to PTP, you will notice the value drifting.

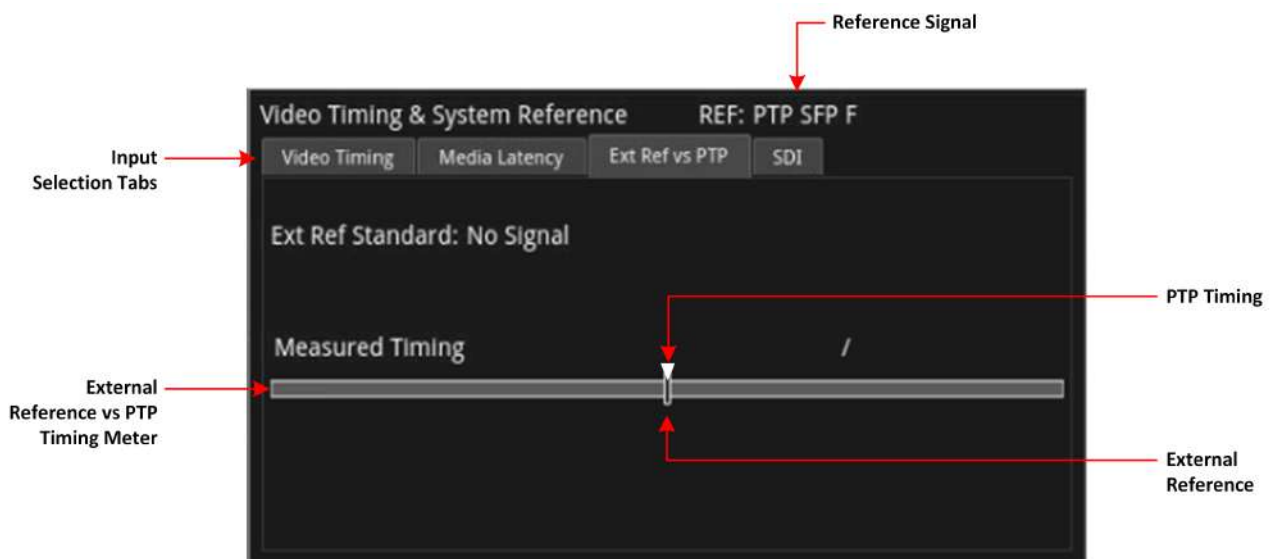

Figure 4-31: Ext Ref vs PTP Tab of the Video Timing & System Reference Instrument (ST 2110 IP Input)

Media Latency Tab

The **Media Latency** tab displays the end-to-end latency of each ST 2110 flow, between the source and the unit, when both are locked to PTP. Any latency represents the time delay between the point at which a packet is created at the source and the point at which it is received. The *latency period* includes the length of time it takes to send the packet and the time taken by the packet to travel across the network. The unit calculates the latency by comparing the timestamp in the RTP packet header with the hardware timestamp at the time of ingest.

This tab provides both a graphical display of latency in the horizontal timing meters and a tabular display of the actual corresponding mean values in the right-hand **Mean** column. In the scalar view, the white arrows indicate the current latency, offset from PTP, and the black arrows show the historical maximum and minimum values. The actual mean values are shown in the Mean column to the right.

Note: Monitoring of audio flows **AUD 3** and **AUD 4** is not supported in the current software release.

This tab aims to show the relationship between the video, audio and ancillary data flows and consequently, to indicate the amount of buffering required at the receiver to synchronize the flows.

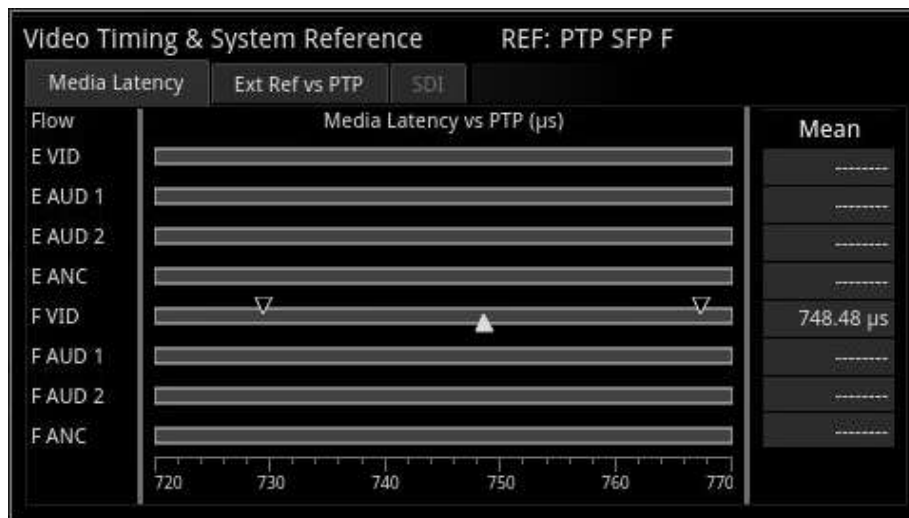

Figure 4-32: Media Latency Tab of the Video Timing & System Reference Instrument (ST 2110 IP Input)

The **Media Latency** measure is the difference between the arrival time of a packet and the RTP timestamp of that packet, averaged over 1 second and is calculated as follows:

$$\text{Latency} = \text{TPA}_0 - \text{RTP}_{\text{Timestamp}} \text{ (averaged over 1 second)}$$

Where:

- **TPA₀** is the arrival PTP time of a media packet as measured by the unit
- **RTP_{Timestamp}** is the timestamp within the received packet created by the source.

For Video and ANC flows, the RTP timestamp is constant for the entire Frame, so the latency is only measured when the RTP timestamp changes. This occurs on the first packet of a frame for a progressive flow, or field for an interlaced flow, with the results averaged over 1 second.

For Audio flows, as the RTP timestamp increments with each audio packet the latency is measured for every packet with the results averaged over 1 second.

To see more detail about the media latency, you can zoom in on a specific area of interest by clicking anywhere on a timing meter of interest, which changes the scale to match the values of the specific flow. For example, when zooming into a video flow, the scale changes from milliseconds (ms) to microseconds (μs). Click the meter again to zoom out and return to the overview. You can also switch

between overview and zoom for individual flow meters by selecting the specific meter from the instrument submenu. See the Instrument options table below.

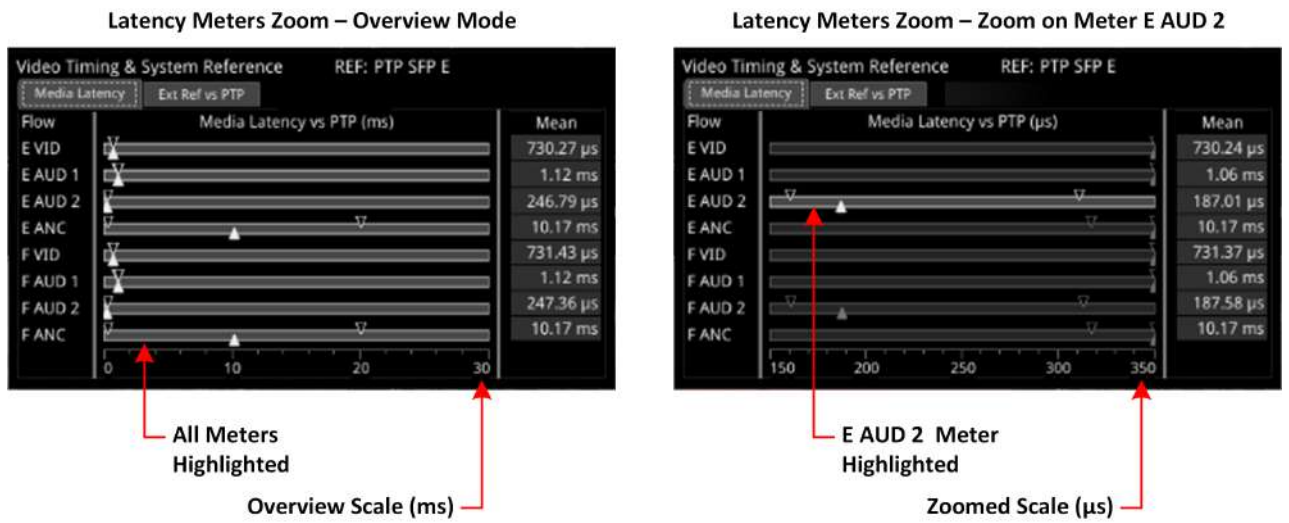

Figure 4-33: Media Latency Tab of the Video Timing & System Reference Instrument (ST 2110 IP Input)

Instrument Menu Options

The following table lists the configurable parameters, available with a standard core license, in the **Video Timing & System Reference** instrument options menu for IP input to the Analyzer:

Table 4-17 : Video Timing & System Reference Menu Options (ST 2110 IP Input)

Item	Options	Description
Ext Ref vs PTP Tab Options		
System Reference	Free Run (Default) Ext Ref SDI (SDI Input Only) PTP SFP E PTP SFP F	<p>System reference locking controls define the reference to which the unit and any signal it generates is locked.</p> <p>By selecting the default option Free Run, the system locks to the internal oscillator as the timing reference signal. If the system loses the external reference signal for some reason, the system will automatically switch to use the Free Run reference signal.</p> <p>System reference lock status information is displayed in the title bar of the instrument, and any error in the health state of the reference is displayed in red.</p> <p>For ST 2110 IP input, make sure that the system reference is stably locked to the same PTP source as the sending device.</p> <p>System reference lock status information is displayed in the upper-right corner of the instrument, and any error in the health state of the reference is displayed in red.</p>
Ext Ref Termination	Enabled Disabled (Default)	When enabled, adds an internal 75 ohm termination to the reference input to stabilize the system

Item	Options	Description
		reference signal. Note: This termination may be temporarily disrupted during power cycles, Analyzer input changes and upgrades.
Ext Ref Meter Range	+/- 0.1 line +/- 0.5 line (Default) +/- 0.5 frame	Adjusts the displayed range of the external reference timing meter in the upper section of the Instrument to display readings at frame scale, or to zoom in to a fraction of a line.
Input Offset Type	Lines And Pixels Time	Defines whether to apply an offset using spatial (lines/pixels) or temporal (μ s, ns) values.
Input Time Offset	0.00, +/- 0.01, etc...	For Time as the offset type, set the timing offset in microseconds (μ s).
Input Line Offset	0 to +/- (Total number of Lines in the current standard minus one.)	For Lines And Pixels as the offset type, set the course timing offset as a number of lines.
Input Pixel Offset	0 to +/- (Total number of Pixels per Line in the current standard minus one.)	For Lines And Pixels as the offset type, set the fine timing offset as a number of pixels.
Set Input Offset to current	N/A	Sets the input offset to the same position as the current Decapsulated signal.
Clear Input Offset	N/A	Removes any input offset.
Media Latency Tab Options		
Latency Meters Zoom	Overview (Default), E VID, E AUD 1, E AUD 2, E ANC, F VID, F AUD 1, F AUD 2, F ANC	Select a specific timing meter to switch between overview and zoomed-in view.
Anchor Overview Scale	Zero (0) or less, Any value	Anchor time scale start in Overview mode. Set the start point of the timescale when in Overview.
Clear Min, Max values	System Control	Set the historical minimum and maximum values back to zero.

Note: Monitoring of audio flows **AUD 3** and **AUD 4** is not supported in the current software release.



Overview

The **IP Receive - Flows** instrument enables you to instruct the unit to issue an IGMP request manually, categorize the SMPTE protocol type of each received flow, and then select IP flows for analysis. The Multicast Requests table lists the IP flows together with their parameters. The IP flows include those that match multicasts to which the unit has subscribed, together with multicast and unicast flows that have been sent to the unit.

When under AMWA NMOS control, the unit automatically issues an IGMP request, categorizes and selects a flow, all under the control of a Session Description Protocol (SDP) transport file.

For ST 2110 input the unit can simultaneously process the following:

- One 2110-20 video flow
- Any of the following combinations of 2110-30 linear PCM or 2110-31 AES-3 audio flows to the maximum limits below (at 125 μ s packet times):
 - With 2110-30 linear PCM, either:
 - One audio flow of up to 80 channels, or
 - Two audio flows of up to 64 channels each, or
 - Four audio flows of up to 32 channels each.
 - With 2110-31 AES-3, either:
 - One or two audio flows at up to 60 channels, or
 - Four audio flows of up to 32 channels each.
- One ancillary (ANC) flow.

Note: You can configure the number of audio flows in the options menu.

For ST 2022-6 input to **SFP E** or **SFP F**, you can select one flow at a time for processing.

Note: Allocation of a media flow type or protocol is independent of the Payload Type ID number, so it is possible to have several different media flow types with the same Payload Type ID.

Detailed information for each flow is provided in the Multicast Requests table as follows:

- SFP Port (E or F)
- Channel Allocation (Video, Audio 1, Audio 2, Audio 3, Audio 4, ANC)
- SMPTE Media Protocol (2110-20, -30, -40, etc.)
- Payload Type ID Number
- Destination and Source IP Addresses and Port Numbers
- Synchronization Source (SSRC) Identifier
- Mean Flow Bandwidth averaged over 1 second
- Total Packet Counts
- Sequence Error Count.

Both Sequence Payload and CRC errors are displayed in the **Seq errors** count column. You can sort the table by any parameter column, and once configured, left-click a flow for further analysis.

The overall status of the Multicast IGMP requests is displayed above the table, for example: Multicast Requests: 18/18 joins sent. Multicast IGMP join and leave requests can be controlled using the submenu, and the maximum level of IGMP requests can be configured in the **SFP IP Network** Instrument.

Flow protocol configuration management is available from the options menu, and incoming flows with unassigned protocols (Other IP) can also be quickly configured by right-clicking the flow, then assigning the flow type and analysis path in the configuration window.

For both ST 2022-6 and ST 2110 IP input, **IP Receive - Flows** supports the reception of flows on **SFP E** or **SFP F**, as well as ST 2022-7 Seamless IP Protection Switching (SIPS) of pairs of flows on **SFP E + F**.

Note: SIPS protection of a flow pair is available across **SFP E + F**, however, SIPS protection of a flow pair within a single SFP is not supported.

IP Receive - Flows										Analyser Interface: SFP E
Multicast Requests: 12/12 Joins sent										
SFP	Sel	Protocol	Type	Dst IP	Src IP	SSRC	Bandwidth	Packets	Seq errors	
E	VID	2110-20	96	239.9.20.1:5178	192.168.10.20:5178	123456	0 bps	2905187219	30	
E	AUD 1	2110-30	97	239.9.30.1:5178	192.168.10.20:5178	123456	0 bps	1737966	0	
E	AUD 2	2110-30	97	239.9.30.3:5178	192.168.10.20:5178	123456	0 bps	1743209	0	
E	AUD 3	2110-30	97	239.9.30.5:5178	192.168.10.20:5178	123456	0 bps	1745785	0	
E	AUD 4	2110-30	97	239.9.30.7:5178	192.168.10.20:5178	123456	0 bps	1748890	0	
E	ANC	2110-40	100	239.9.40.1:5178	192.168.10.20:5178	123456	0 bps	13010	0	
F	VID	2110-20	96	239.9.20.2:5178	192.168.10.30:5178	123456	0 bps	2904990706	30	
F	AUD 1	2110-30	97	239.9.30.2:5178	192.168.10.30:5178	123456	0 bps	1736802	0	
F	AUD 2	2110-30	97	239.9.30.4:5178	192.168.10.30:5178	123456	0 bps	1741980	0	
F	AUD 3	2110-30	97	239.9.30.6:5178	192.168.10.30:5178	123456	0 bps	1744448	0	
F	AUD 4	2110-30	97	239.9.30.8:5178	192.168.10.30:5178	123456	0 bps	1747579	0	
F	ANC	2110-40	100	239.9.40.2:5178	192.168.10.30:5178	123456	0 bps	13001	0	

Figure 4-34: IP Receive - Flows Instrument Displaying Overview of Multicast Requests Sent

Media flows may have already been presented to the unit either by a unicast sender, a network orchestrator or by the unit being attached to a switch or router mirror port or passive optical tap. In these situations, the details of the media flow are automatically displayed in the Flows window.

If the unit is required to initiate a multicast session by way of an IGMP request then this can be achieved either automatically, using either the JSON API or NMOS; or manually, by right-clicking in the **IP Receive - Flows** instrument and selecting **Multicast/Flow Config...** from the options menu. This displays a window with the selectable tabs:

- **Multicast Requests** see [Multicast Setup \(Multicast Requests\)](#)
- **Flow Configuration** see [Flow Protocol Configuration \(Flow Config\)](#)
- **NMOS Flow Config** see [NMOS Flow Configuration \(NMOS Flow Config\)](#).

The unit can access IP flows using either IGMP v1, v2 or v3 multicast requests, with the maximum level of an IGMP request configured in the options menu of the **SFP IP Network** instrument. The selected

maximum IGMP multicast level is applied to all media ports. Once a multicast group is successfully joined, all flows within it will appear in the **IP Receive - Flows** window.

The IP flows with assigned SMPTE protocols listed in the window are those currently available for selection on the chosen interfaces. Click to select a flow for analysis; the selected flow is then highlighted.

Note: If you insert a 25G SFP in either the SFP E or F module cages when the 25G IP license (**PHQXO-IP-25G**) is not installed, the Instrument title will change color to red. If you hover the cursor over the title the following error message is displayed:

Error: IP 25G License: Not Present. Inserted 25G SFPs will not function.

Instrument Menu Options

The options menu, accessed by right-clicking the **IP Receive - Flows** window, calls-up a multicast and flow configuration settings dialog, persistence, 2022-7 and audio flow settings, and in addition list and selection clearing controls.

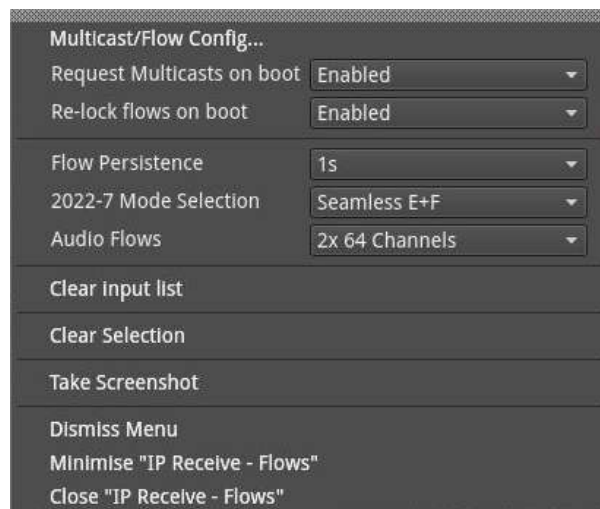

Figure 4-35: IP Receive - Flows Instrument Options Menu

The following table lists the configurable parameters in the **IP Receive - Flows** instrument options menu:

Table 4-18 : IP Receive - Flows Menu Options

Item	Options	Description
Multicast/Flow Config	Dialog selection	Click to open a new dialog box with tabs for Multicast Requests (see Multicast Setup (Multicast Requests)), Flow Config (see Flow Protocol Configuration (Flow Config)) and NMOS Flow Config (see NMOS Flow Configuration (NMOS Flow Config)) as previously described.
Request Multicasts on boot	Enabled (Default) Disabled	When enabled, sets the unit to request to receive Multicast flows automatically on re-boot.
Re-lock flows on boot	Enabled (Default) Disabled	When enabled, sets the unit to re-lock to the selected flows automatically on re-boot.
Flow Persistence	1 s 10 s 30 s 1 min 5 min	Sets the amount of time that old, inactive flows remain displayed in the Flows window

Item	Options	Description
	10 min Infinite	
2022-7 Mode Selection	SFP E SFP F Seamless E+F	<p>Choose whether you want to analyze flows available on one or both SFP receiver interfaces for ST 2022-6 or ST 2110 IP input. The current interface mode is displayed in the top right-hand corner of the instrument window (Analyzer Interface).</p> <p>For ST 2022-6 IP input, you can select a single video flow for analysis at a time. For ST 2110 IP input, you can select up to six flows per interface (one video, four audio and one ANC) at the same time.</p> <p>When ST 2022-7 seamless IP protection switching (SIPS) is enabled (Seamless E+F), the SIPS functionality provides seamless reconstruction by using packets from either flow to compensate for possible packet loss or corruption.</p>
Audio Flows	1 x 80 Channels 2 x 64 Channels 4 x 32 Channels (Default)	<p>Note: This applies to ST 2110 flows only.</p> <p>Set the maximum number of received audio flows and audio channels for each interface. The default setting is four flows per interface at up to 32 channels per flow.</p>
Clear input list	System control	Click to clear the displayed list of available flows and the Packet and Sequence Error counters.
Clear Selection	System control	Click to deselect the currently selected flow(s).

Manual Multicast Setup

To access the **Multicast Setup** dialog, select the **Multicast/Flow Config...** option from the instrument options menu and click the **Multicast Requests** tab if not already selected.

Enter the details of the multicast to join and the desired SFP interface, using the controls in the bottom-right corner of the **Multicast Requests** tab.

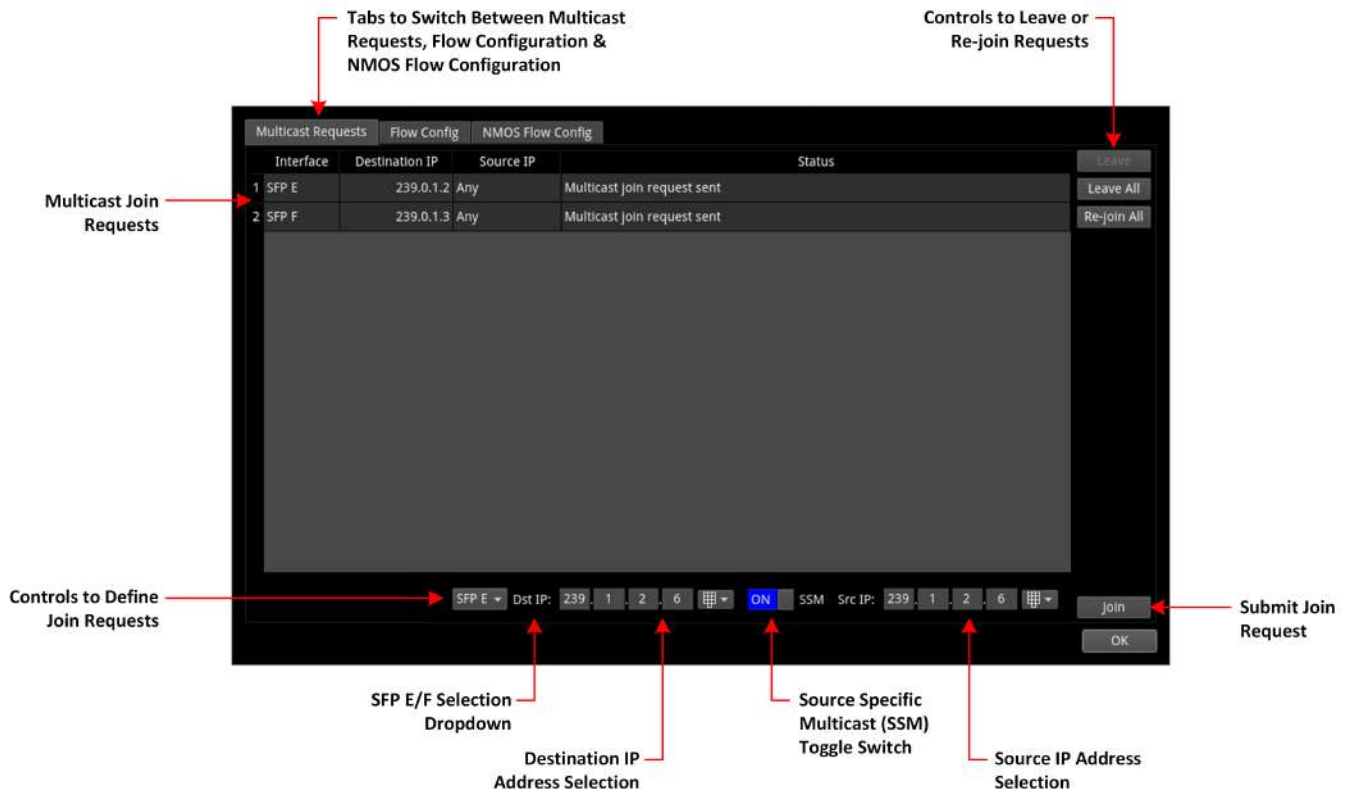

Figure 4-36: IP Receive - Flows: Multicast Requests Tab

Using the Instrument Controls

Select interface **SFP E** or **SFP F** from the dropdown list.

Enter the destination IP address of the multicast group to join in the **Dst IP** fields using either a USB keyboard or the soft keypad. Alternatively, hover over the number to adjust and use the mouse scroll wheel to increase or decrease the number within the following range:

- Dst IP: > [224.0.0.1 to 239.255.255.255]

You can choose to use **Source Specific Multicast (SSM)**, in conjunction with IGMPv3, to ensure that the unit receives packets originating from the source IP address that you select. To use SSM, select the **SSM** checkbox.

Note: IGMPv1 and IGMPv2 do not support SSM.

To send the multicast join request, click: **Join**.

This join request is added to the table of multicast requests in the tab dialog window, together with the status of the join request.

To join a multicast already listed in the table, but not joined, or to resend a join request for a multicast that has already been joined, select it and then click **Join**.

To exit a multicast, select it from the table in the dialog box, then click:

- **Leave**

To exit all multicasts, select:

- **Leave All**

A prompt window is displayed, asking you to confirm that you want to leave all multicasts.

To request to re-join all multicasts currently listed in the dialog box table, select:

- **Re-join All**

To close the **Multicast Requests** dialog window, click:

- **OK**

To set the unit to request to re-join all multicasts currently listed in the dialog box table, automatically on reboot, return to the instrument options menu and set the parameter **Request Multicasts on boot** to **Enabled**.

Flow Protocol Configuration(Flow Config)

Having successfully joined a multicast, or if media traffic has already been routed to the unit, then all the associated flows will be visible in the **Flows** table.

The multi-flow nature of SMPTE ST 2110 means that a fairly complex labeling procedure is required to identify the various flows and their specific parameters. Before using an incoming ST 2110 IP flow, it is important first to identify the type of SMPTE protocol flow you are dealing with, in order to analyze it correctly.

Note: If an IGMP join has been initiated under NMOS control, then all flow parameters will be automatically configured using the information in the Session Description Protocol (SDP) transport file.

If a media flow type is not recognized by the unit, then the protocol type is identified as **Other IP**, and automatically appears in the **Unconfigured Flows** table in the **Flow Config** dialog, which maintains the list of flow protocol configurations. Use this dialog to assign the protocol to an unconfigured flow or change the protocol of a flow.

Configure the Flow protocol either by left-clicking the **Other IP** label of a flow in the **Flows** window, or by using the **Flow Config** tool, which maintains the list of flow protocol configurations.

The unit automatically stores all flow configurations and this list builds up over a period of time. Media flows can also be preconfigured, before being requested.

Using the Flow Config Controls

Select **Multicast/Flow Config...** in the instrument options menu, then click the **Flow Config** tab.

The dialog box displays the following window:

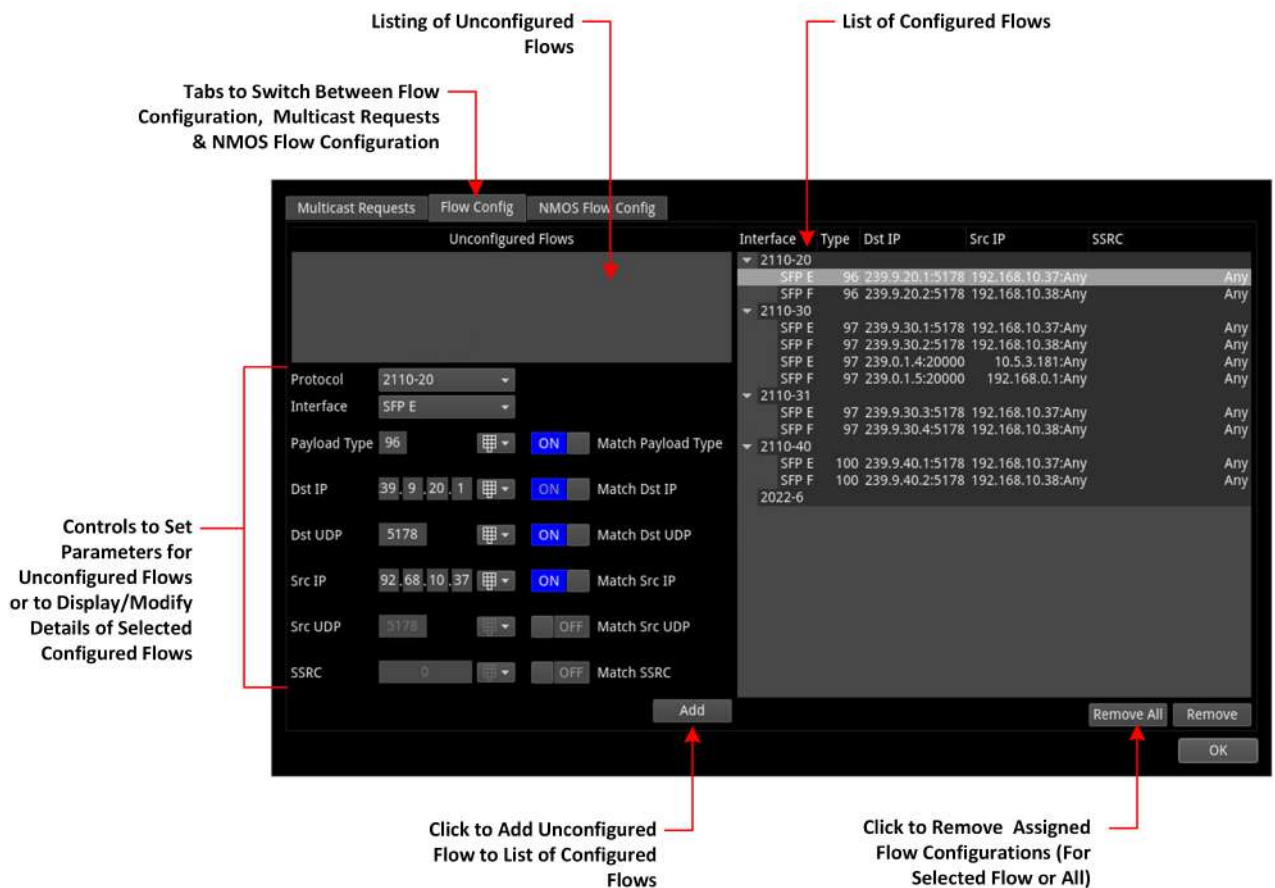

Figure 4-37: IP Receive - Flows: Flow Config Tab

- The left-hand pane displays any unconfigured flows together with controls to set any user-controlled parameters that you can apply
- The right-hand pane displays all configured flows, organized by protocol type. If you select a single flow in this pane, the unit populates the flow details in the fields and checkboxes below the Unconfigured Flows pane. In manual operation, only the **Match Destination (Dst) IP** checkbox is checked by default. You can select other checkboxes as required. When a checkbox is unchecked, **Any** is displayed in the corresponding field in the Configured Flows pane.
- When under automatic NMOS control, the following checkboxes are selected by default:
 - Payload Type
 - Destination IP Address
 - Destination UDP Port Number
 - Source IP Address.

To configure a flow, select one in the **Unconfigured Flows** window. Its current parameters populate the flow parameter controls below the panel.

Using the controls, select options as required:

- **Protocol** options for ST 2110 IP input:
 - 2110-20 (video)
 - 2110-30 (PCM audio)
 - 2110-31 (AES 3 audio)
 - 2110-40 (ancillary).
- **Protocol** option in ST 2022-6 IP input:
 - 2022-6.

Where an SSRC ID is included in an available flow, decide whether you want to analyze the flow only when this SSRC is matched.

Once you have configured a flow, click **Add** to move it into the right-hand pane of configured flows.

To remove the current configuration assigned to a flow, click **Remove** or click **Remove All** to clear all flow configurations. If you choose **Remove All**, you are prompted to confirm that you want to remove all configured flows. Click **Remove All** to proceed.

If the flow is still present on one of the SFP interfaces, it will appear back in the **Unconfigured Flows** window, where it can be modified, if required.

On completion, click **Ok** to close the **Flow Config** window.

NMOS Flow Configuration (NMOS Flow Config)

When the unit generates an NMOS IS-05 join, the configured flows match against the following iGMP and NMOS parameters by default:

- Payload Type
- Destination IPv4 Address (Dst IP)
- Destination UDP Port Number (Dst UDP)
- Source IPv4 Address (Src IP)

There may be occasions in a typical network environment when these parameters do not match perfectly so the unit provides the ability to adjust the precision of flow matching by manually de-selecting one or more of these parameters. For example, if you deselect **Payload Type**, the flows will match on the remaining three parameters: **Dst IP**, **Dst UDP** and **Src IP**.

If you de-select the Source IPv4 address, the unit will not issue an IGMP source-specific multicast join request as the source IP address can no longer be used.

If you deselect any of the matching parameters, be sure to click **OK** to apply your changes.



Figure 4-38: IP Receive - Flows: NMOS Flow Config Tab

Analyzer - 2110 Format Setup (ST 2110 IP Input)



Overview

The **Analyzer - 2110 Format Setup** instrument automatically evaluates the received and selected ST 2110-20 video flow and estimates the appropriate video standard for that flow.

Two tabs provide access to the separate Video and Audio parameters, enabling you to define manual override parameters for one video flow and up to four audio flows.

Features include:

- Automatic estimation of video format parameters for ST 2110-20 flows
- Extraction of video format parameters from an SDP record by way of NMOS for ST 2110-20 flows
- User-configurable video format parameters for ST 2110-20 flows.

Video Tab Setup

In the **Video** tab, the video parameters are displayed in three columns to show their source as follows:

- **Auto:** Lists the video parameters automatically detected from the received flow
- **SDP:** Lists the video parameters extracted from the Session Description Protocol (SDP) record, provided by NMOS, if available. If you use an SDP record to select a flow, then the format parameters are populated automatically from the SDP transport file.
- **Override:** Lists any manually entered video parameters, which you can use to override the auto-detected or SDP parameters and apply them to the flows selected for analysis, if necessary.

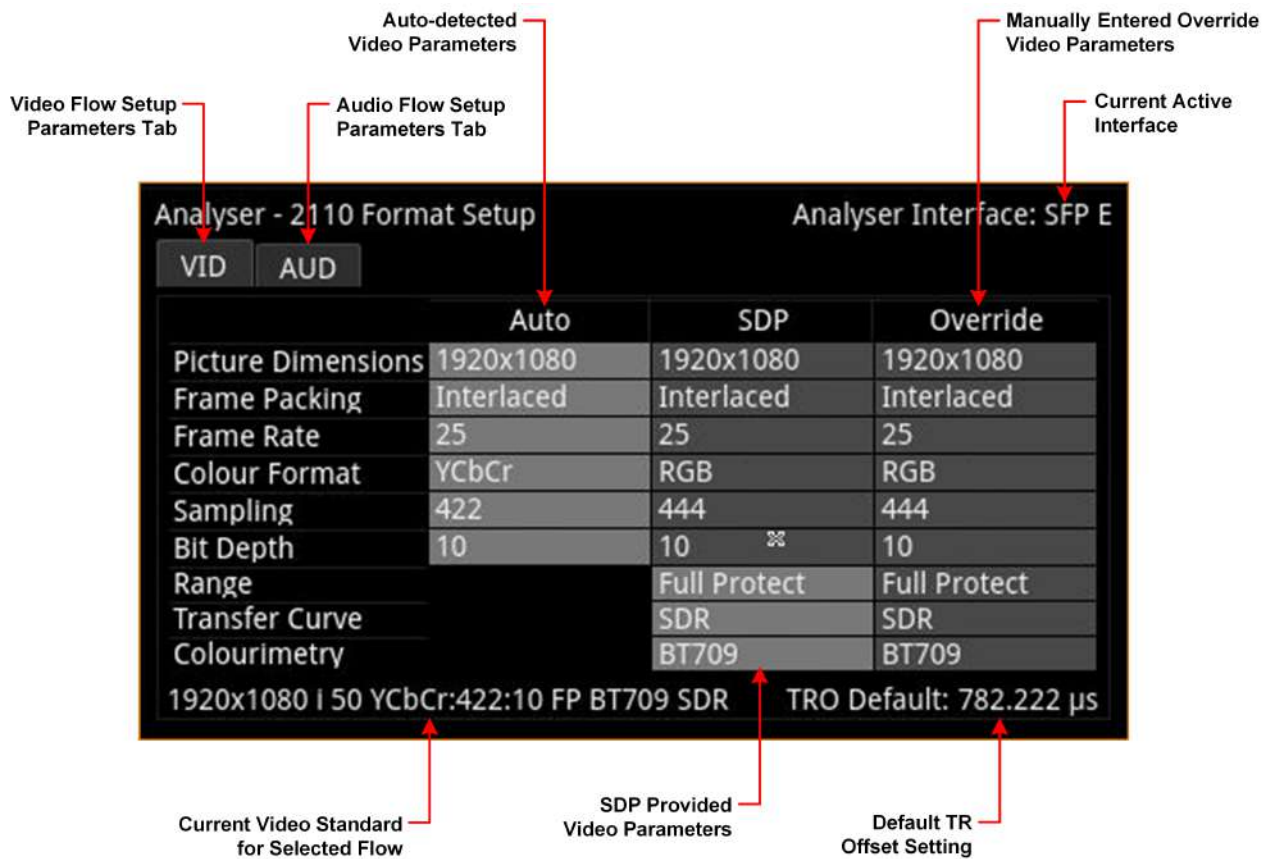

Figure 4-39: Analyzer - 2110 Format Setup Instrument - Video Tab

Note: If the 2110 Format Setup instrument is active but the unit is configured to analyze either an ST 2022-6 IP or optional SDI input, you will see the following warning message displayed in the window: **Invalid Input**.

To resolve, make sure that the analyzer input is set to **IP** and that the input source is **ST 2110**.

The Analyzer - 2110 Format Setup Instrument automatically estimates the following parameters for a selected 2110-20 video flow:

- Picture dimensions (height and width)
- Frame packing type (interlaced, progressive, or segmented)
- Frame rate
- Color format
- Sample format
- Bit depth.

All parameters currently in use by the video standard are displayed in a bold white font, with unused parameters grayed-out. If the flow is selected using an SDP, the unit extracts the video parameters from the SDP record and displays them in the SDP column. If an SDP record is not available, the SDP column is grayed-out and no parameters are listed. SDP parameters are currently provided only if you select the flow using an SDP available through NMOS. If you later manually deselect the flow, and then reselect it, the SDP parameters will be lost.

If necessary, you have an option to use the manual override parameters instead of the automatically estimated or SDP parameters. If you do so, the auto-estimated and SDP parameters remain available and displayed but are not used. The default manual override is the same as the current default video standard, for example: **1920x1080 i 50 YCbCr:422 10 FP SDR 709**.

When using Auto-estimation, where a video parameter can be estimated correctly, the auto-estimated parameters take priority over the supplied SDP parameters (if available). When it is not technically possible to auto-estimate a parameter, then either the SDP values (if available) or the manual override settings are adopted instead.

It is not technically possible to auto-estimate the Range, Transfer Curve or Colorimetry parameters so these are taken either from the SDP file (if available) or the manual override settings (if defined). Furthermore, it is not possible to distinguish automatically between either YCbCr:444 and RGB:444, or YCbCr:422 12 bit and RGB:444 8 bit formats. In these situations the Auto Detector will report **Undetermined** in red font in the corresponding field of the **Auto** column.

Analyser - 2110 Format Setup		Analyser Interface: SFP E	
VID	AUD		
	Auto	SDP	Override
Picture Dimensions	1920x1080		1920x1080
Frame Packing	Interlaced		Interlaced
Frame Rate	25		25
Colour Format	Undetermined		YCbCr
Sampling	444		422
Bit Depth	10		10
Range			Narrow
Transfer Curve			SDR
Colourimetry			BT709
1920x1080 I 50 YCbCr:444:10 BT709 SDR		TRO Default: 782.222 µs	

Figure 4-40: Analyzer - 2110 Format Setup Instrument Showing Undetermined Parameter

In the event that a parameter does not match the parameter currently in use, that parameter is displayed in a yellow font to highlight the mismatch. For example, the following screen shows that the color format and sampling parameters in the SDP file do not match those in the Auto column currently in use.

Analyser - 2110 Format Setup		Analyser Interface: SFP E	
VID	AUD		
	Auto	SDP	Override
Picture Dimensions	1920x1080	1920x1080	1920x1080
Frame Packing	Interlaced	Interlaced	Interlaced
Frame Rate	25	25	25
Colour Format	YCbCr	RGB	YCbCr
Sampling	422	444	422
Bit Depth	10	10	10
Range		Full Protect	Narrow
Transfer Curve		SDR	SDR
Colourimetry		BT709	BT709
1920x1080 I 50 YCbCr:422:10 FP BT709 SDR		TRO Default: 782.222 µs	

Figure 4-41: Analyzer - 2110 Format Setup Instrument Showing Unmatched SDP Parameters

The 2110 Format Setup Instrument estimates the standard for the 2110-20 video flow on both interfaces **SFP E/F**, with the video standard used depending on the setting of the current analyzer interface. If the unit is in **Seamless E+F** mode, then the parameters from **SFP E** are used unless no flow is present or a fault is identified, in which case, the parameters from **SFP F** are used.

Colorimetry Range and Bit Depth Support

From software version 5.4, the unit supports the detection and analysis of SMPTE Full Range video standards, in addition to SMPTE Narrow Range, when the Range parameter is specified in the SDP Record. The Qx Series of PHABRIX instruments uses the definitions for Narrow, Protected (Full Protect) and Full Range as defined in SMPTE RP 2077 *Full-Range Image Mapping*.

Full, Protected and Narrow ranges for 10- and 12-bit depths, as implemented in the QxL, are summarized in the following table for IP 2110 boot mode:

Range Type	IP 2110-20 Code Value Digital Representations		
	8-Bit Range	10-Bit Range	12-Bit Range
Full Range (FR)	255	1023	4095
Full Protected Range (FP)	254	1019	4079
Narrow Range (NR)	235	940	3760
↑	.	.	.
↓	.	.	.
Narrow Range (NR)	16	64	256
Full Protected Range (FP)	1	4	16
Full Range (FR)	0	0	0

Figure 4-42: QxL Colorimetry Ranges (ST 2110 IP Input)

Note: When analyzing a video input standard, the unit does not scale up from Protected Range to Full Range or scale down from Full Range to Protected Range.

If using NMOS and the optional Range parameter in the SDP record is set to **Full** or **Full Protect**, you will see this displayed in the SDP column of the 2110 Format Setup overview. If this parameter is not set, then the incoming video is assumed to be SMPTE Narrow range, by default.

When defining manual video override parameters, you can select either Full Range (**FR**), Full Protected Range (**FP**), or Narrow Range (**NR**) colorimetry for any of the available 8-, 10-, or 12-bit depths.

The active colorimetry range is displayed in the definition of the current standard for the selected flow at the bottom of the display, for example:

1920 x 1080 i50 YCbCr:422:10 FR BT709 SDR

For more information on video signal range definitions as implemented in the Qx Series, see the section [Video Range Definitions for the Qx Series](#).

Audio Tab Setup

The 2110 Format Setup Instrument automatically estimates the following parameters for the selected audio flows (AUD1 through AUD4):

- Packet time (ms)
- Channel count.

When using Auto-estimation, where an audio parameter can be estimated correctly, the auto-estimated parameters take priority over the supplied SDP parameters (if available). When it is not technically possible to auto-estimate a parameter, then either the SDP values (if available) or the manual settings are adopted instead.

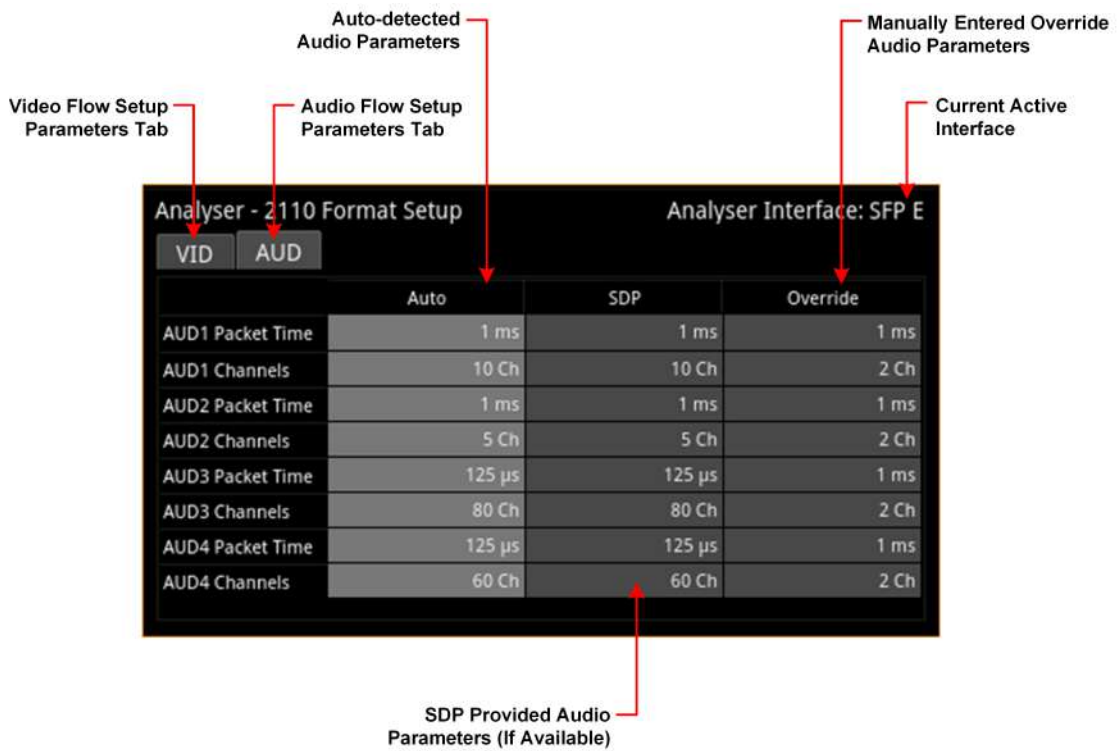

Figure 4-43: Analyzer - 2110 Format Setup Instrument - Audio Tab with Four Audio Flows

Features include:

- User-configurable audio format parameters for ST 2110-30 flows includes packet time and channel count
- Automatic detection of audio format, channel count and packet time.

Instrument Menu Options

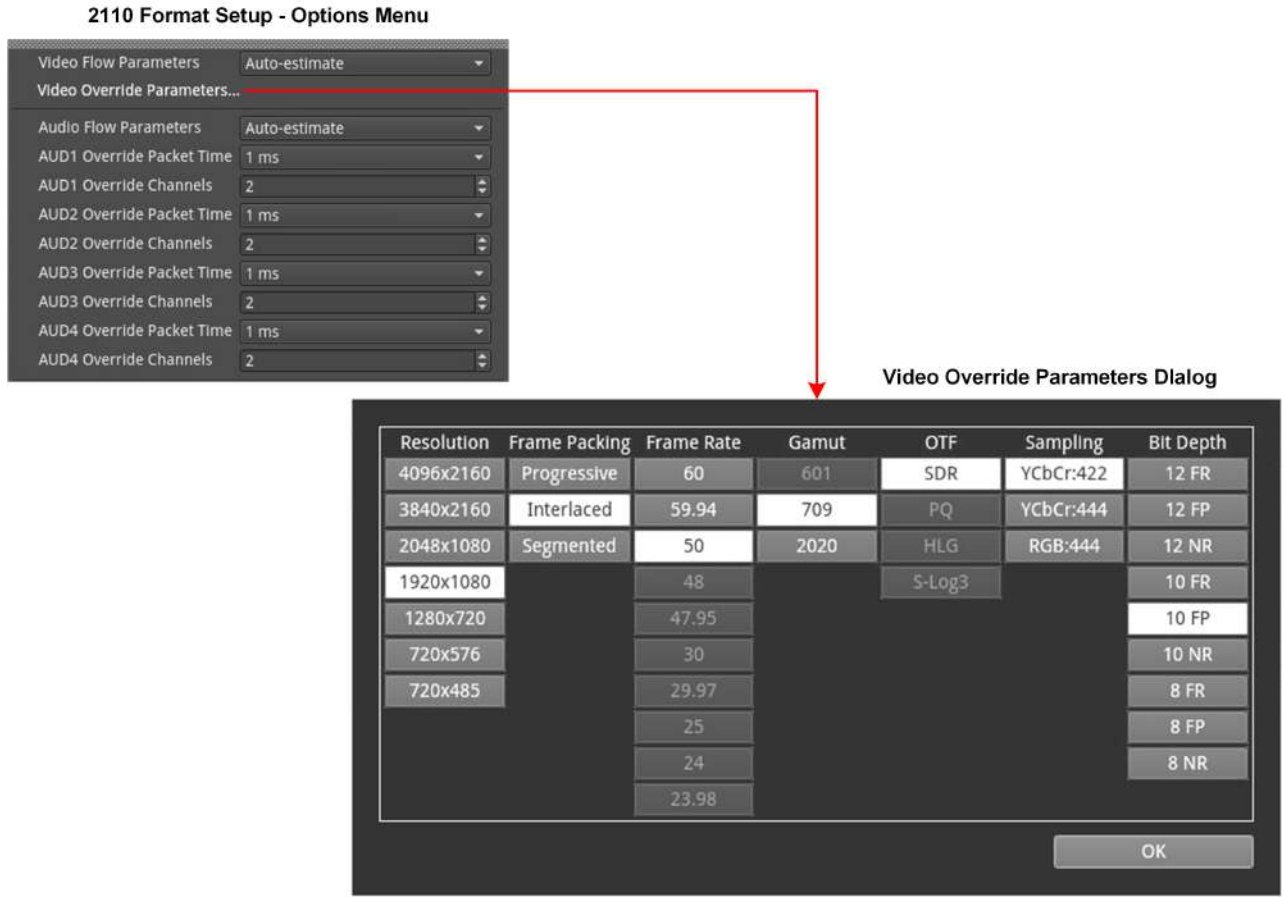

Figure 4-44: Analyzer - 2110 Format Setup Instrument - Options Menu and Video Override Parameters Dialog

The following table lists the video and audio format parameter options, available to select for the Override column, in the Analyzer - 2110 Format Setup instrument options menu:

Table 4-19 : Analyzer - 2110 Format Setup Menu Options

Item	Options	Description
Override Video Flow Parameters		
Video Flow Parameters	Auto-estimate (Default) Override	<p>When set to Auto-estimate the unit attempts to determine the incoming IP video standard automatically. When successful, the unit uses these parameters to set up the video.</p> <p>In the event that the unit cannot estimate a video parameter, then it uses the video standard from an SDP file if one is available (currently only by way of NMOS); otherwise it uses the Override parameters.</p> <p>Note: The unit cannot currently estimate the parameters OTF (transfer curve) and Gammut(colorimetry) so always uses the SDP (if available) or Override parameters.</p> <p>When set to Override the unit uses the parameters defined in the video override parameters dialog to set-up the video together with the audio override parameters defined in the options menu.</p>

Item	Options	Description
Video Override Parameters...	System Control	Opens the Video Override Parameters configuration dialog.
Override Video Flow Parameters		
Resolution	1280 x 720 1920 x 1080 2048 x 1080 3840 x 2160 4096 x 2160	Select the appropriate picture dimensions for the flow.
Frame Packing	Interlaced Segmented Progressive	Select the appropriate frame packing method for the flow.
Frame Rate	23.98, 24, 25, 29.97, 30, 47.95, 48, 50, 59.94, 60	Select the appropriate frame rate for the flow.
Gamut	601 709 2020	Select the appropriate colorimetry standard for the flow.
OTF (Optical Transfer Function)	SDR PQ HLG Unspecified	Select the appropriate override transfer curve for the flow. Note: The option Unspecified forces the OTF setting to S-Log3.
Sampling	YCbCr:444 YCbCr:422 RGB:444	Select the appropriate sampling method for the flow.
Bit Depth	8 bit (FR, FP, or NR) 10 bit (FR, FP, or NR) 12 bit (FR, FP, or NR)	Defines the colorimetry bit-depth and range (Full (FR), Full Protected (FP), or Narrow (NR)) of the incoming video standard when using manual override parameters.
Override Audio Flow Parameters		
Audio Flow Parameters	Auto-estimate (Default) Override	If you select the option Override , you can manually set the following fields (the maximum number of Channels depends on the Packet Time set):
AUD1 Packet Time	1 ms 125 μ s	Enabled only when Audio flow parameters option is set to Override.
AUD1 Channels	1 to 10 at 1 ms 1 to 80 at 125 μ s (2110-30) 1 to 60 at 125 μ s (2110-31)	Enabled only when Audio flow parameters option is set to Override.
AUD2 Packet Time	1 ms 125 μ s	Enabled only when Audio flow parameters option is set to Override.
AUD2 Channels	1 to 10 at 1 ms 1 to 80 at 125 μ s (2110-30) 1 to 60 at 125 μ s (2110-31)	Enabled only when Audio flow parameters option is set to Override.
AUD3 Packet Time	1 ms 125 μ s	Enabled only when Audio flow parameters option is set to Override.
AUD3 Channels	1 to 10 at 1 ms 1 to 80 at 125 μ s (2110-30) 1 to 60 at 125 μ s (2110-31)	Enabled only when Audio flow parameters option is set to Override.

Item	Options	Description
AUD4 Packet Time	1 ms 125 μ s	Enabled only when Audio flow parameters option is set to Override.
AUD4 Channels	1 to 10 at 1 ms 1 to 80 at 125 μ s (2110-30) 1 to 60 at 125 μ s (2110-31)	Enabled only when Audio flow parameters option is set to Override.

AES IO Config (ST 2110 IP Input)



Overview

The unit provides powerful and flexible functionality for handling AES (Audio Engineering Society) input and output signals when present on pins 1 - 4 of the rear panel 26-way D-type connector. See the section [Technical Specifications](#) for more information on the connector pinouts. You can use a D-type to BNC converter to access the AES I/Os.

The **AES IO Config** Instrument provides a configurable gateway to the AES IO signals for ST 2110 IP inputs. You can configure the AES IO so that an audio pair from the 2110-30 / -31 input is routed to the four AES3 output interfaces. Encoded audio, such as AC-3, or E-AC3, can be decoded by an external third-party decoder for monitoring purposes. Encoded Dolby E™ can be decoded directly by the unit.

The **AES IO Config** Instrument provides an interface to configure the AES I/Os as follows :

- Up to four AES signals (a combination of inputs and/or outputs) can be handled at the same time
- SDI Input to AES Output audio conversion is available for both PCM and Dolby® encoded audio (using the **Transmit - Analyzer**)
- Decoded Dolby E™ input from any of the four decoded Dolby pairs, together with the down-mixed pair, can be routed out (using the **Transmit - Dolby Decoder**)
- Route AES Input signals to other AES outputs to provide a single loop output or up to three copy outputs (using **Transmit - Passthrough**).

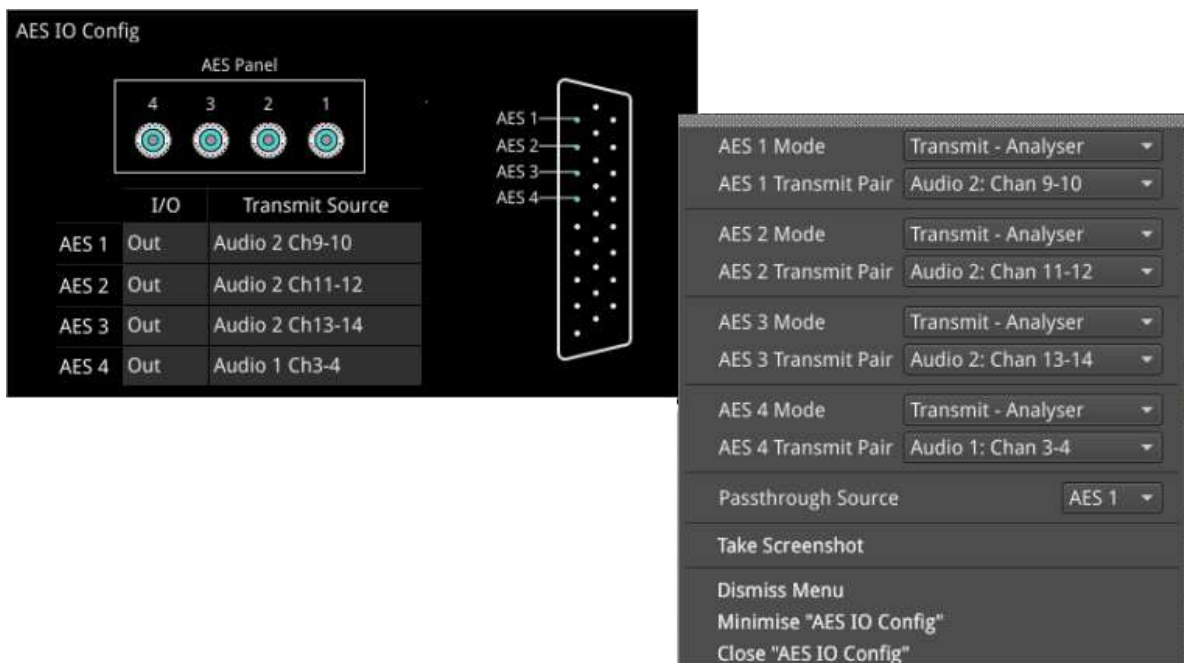

Figure 4-45: AES IO Config Instrument and Options Menu (ST 2110 IP Input)

The instrument provides a graphical display of the 26-way D-type rear panel connector of the unit, and labels the AES pins (pins 1 - 4). The AES Panel graphic shows the AES I/O BNCs in any AES breakout board connected to the rear panel D-type connector.

In both graphics, an active AES I/O is displayed in the Analyzer color when configured as an AES Input (in Receive mode) or in the Generator color when configured as an AES Output (in Transmit mode).

Below the AES Panel graphic, a table lists the status of each AES I/O. For AES Outputs the table also shows the transmit mode source. Any issues in the audio transmit source are highlighted in the table text as follows:

- Red: Configuration error
- Yellow: Audio source not present

Hover the mouse over the error text to display a tooltip describing how to resolve the issue.

Instrument Menu Options

The following table lists the configurable parameters for the AES IO instrument:

Table 4-20 : AES IO Menu Options (ST 2110 IP Input)

Item	Options	Description
AES 1 Mode	Off	AES I/O is switched off
AES 2 Mode	Receive	Set the corresponding AES pin as an output (Transmit). The output audio signal source is the selected channel pair in the Generator Audio tab (e.g. Generator Ch 11 & 12). (See the Audio tab of the Generator – Configuration instrument.)
AES 3 Mode	I/O is set to AES Input	
AES 4 Mode	Transmit - Generator	
	I/O is set to AES Output	
	Transmit - Analyzer	
	I/O is set to AES Output	Set the corresponding AES pin as an output (Transmit). The output audio signal source is the selected channel pair (e.g., Chan 9-10) of the selected Audio Metering flow (Aud 1 to Aud 4). See the section: Analyzer - Audio Meters .
	Transmit - Dolby Decoder	Set the corresponding AES pin as an output (Transmit). The output Dolby E signal source is any of the four decoded Dolby pairs, together with the downmixed pair from the Dolby Decoder. See the section: Analyzer - Audio Meters .
	I/O is set to AES Output	
	Transmit - Passthrough	Set the corresponding AES pin as an output (Transmit) The output audio signal is routed from the chosen AES Passthrough Source.
	I/O is set to AES Output	
AES 1 Transmit Analyzer Pair	With Audio Flows set to 1x 80 Channel: AUD 1: Ch 1 & 2 to 79 & 80	Select the required Audio Meter flow and Audio Pair.
AES 2 Transmit Analyzer Pair		Note: Select the number of received audio flows in the IP Receive - Flows instrument.
AES 3 Transmit Analyzer Pair		
AES 4 Transmit Analyzer Pair		
	With Audio Flows set to 2x 64 Channels: AUD 1: Ch 1 & 2 to 63 & 64 AUD 2: Ch 1 & 2 to 63 & 64	
	With Audio Flows set to 4x 32 Channels: AUD 1: Ch 1 & 2 to 31 & 32 AUD 2: Ch 1 & 2 to 31 & 32 AUD 3: Ch 1 & 2 to	

Item	Options	Description
	31 & 32 AUD 4: Ch 1 & 2 to 31 & 32	
Passthrough Source	AES 1, AES 2, AES 3, AES 4	Set the AES pin corresponding to the passthrough source.

SDI Setup and Configuration

Note: SDI requires one of the factory-fitted hardware options: **PHQXL01-3G** or **PHQXL01E-3G**.

This chapter describes the System Instruments used to set-up and configure the unit for SDI input to the Analyzer and includes the following sections:

- [SDI Connections to the Unit](#)
 - [SDI Input and Output Schematic](#)
 - [SDI Input / Output Configurations \(Optional SDI Output\)](#)
 - [SDI Inputs Using BNC Connectors](#)
 - [SDI Outputs Using BNC Connectors](#)
 - [Overview of SDI SFP Connections](#)
 - [SDI Inputs Using SFP Connectors](#)
 - [SDI Outputs Using SFP Connectors](#)
 - [Video Range Definitions](#)
- [System IO](#)
- [AES IO Config](#)
- [Video Timing & System Reference \(SDI Input\)](#)
- [SFP \(A, B\) - Info](#)

SDI Connections to the Unit (Factory Fitted Option)

Overview

A choice of two SDI connector types – BNC and SFP+ – is available for the transmission of SDI signals in to and out of the unit as shown below.



BNC Connector (Male) on SDI Cable



BNC Connector (Female) on Rear Panel

Figure 5-1: BNC SDI Input / Output Connectors

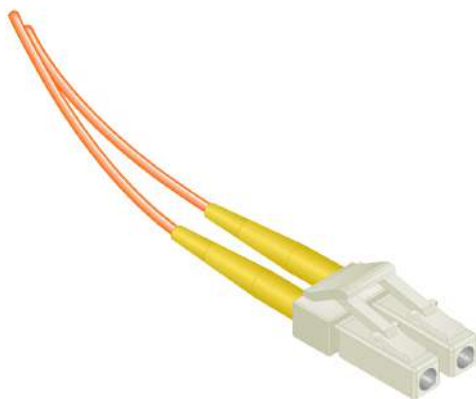

LC-LC Type Optical Fiber (Multimode) Connector



270 Mbit/s – 3 Gbit/s MSA SFP+ Optical Transceiver Module in Rear Panel

Figure 5-2: Optical Fiber Connector and 270M to 3G SFP+ Optical Transceiver Module

SDI Input and Output Schematic (SDI Input/Output)

The following graphic shows a schematic view of SDI inputs and outputs, to and from the Analyzer and Generator circuitry respectively, using either BNC or SFP connectors.

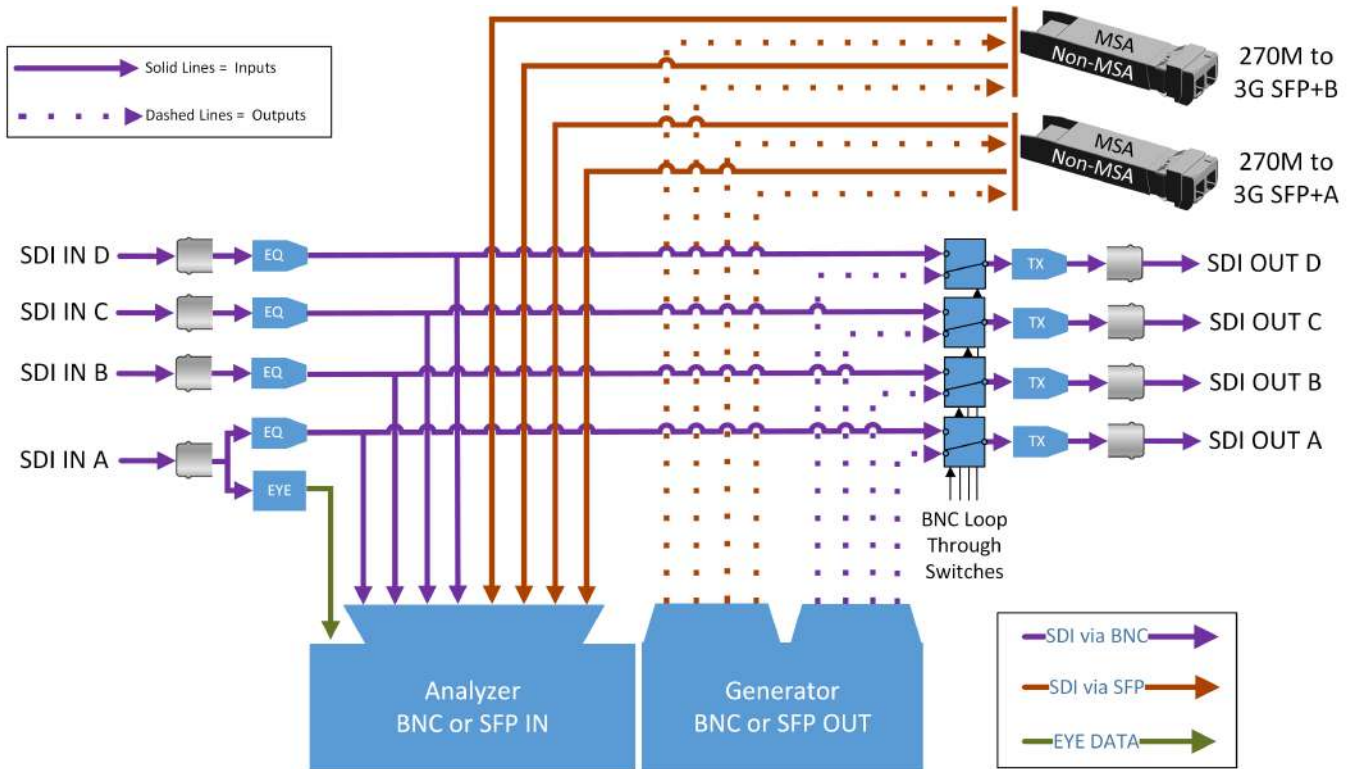

Figure 5-3: SDI Input / Output Connectors to Analyzer / Generator Circuitry

Where:

- **EQ** = SDI Cable Equalizer
- **Tx** = Signal Transmitter
- **EYE** = RTE™ Real-time Eye Processing Circuitry
- **MSA** = Multi-source Agreement Standard.

For SDI Inputs:

- **BNCs:** Lead with **SDI In A**. Note that BNC input connectors **SDI In B**, **SDI In C**, and **SDI In D** are not supported for SD-SDI input.
- **SFPs:** For SD-SDI input, use input **SFP+ Port A** only. Use any input for HD-SDI.

Note: The SDI BNC Loop feature for HD-SDI inputs is available with SDI connector configuration: BNC In / BNC Out only. BNC input connectors **SDI In B**, **C** and **D** are not supported for SD-SDI input. The SDI Loop feature is not supported for SDI SFPs.

Note: It takes marginally longer for the unit to lock-on to SDI Input signals received over SFP connectors than signals received over BNC connectors.

For SDI Outputs:

- **BNCs:** The Generator Output Copy function for HD-SDI outputs is optional in combination with SDI BNC Loop configuration. The generation of SD-SDI video is not currently supported so the Generator Output Copy function is not applicable for SD-SDI signals.
- **SFPs:** Generator Output Copy functionality is always on. The SDI Loop feature is not supported for either SD-SDI or HD-SDI inputs signals.

SDI Input / Output Configurations

You can choose different combinations of BNC and SFP+ connector types for input / output, to and from the unit, from the following:

- BNC In / BNC Out (Default)
- SFP In / SFP Out
- BNC In / SFP Out
- SFP In / BNC Out

Select the SDI connector configuration you require in the **System IO** instrument options menu by configuring the **SDI Input Source** and **SDI Out** parameters. For more information, see: [System IO for SDI Modes \(Factory Fitted Option\)](#).

Note:

Use only SDI SFPs recommended by PHABRIX. The unit displays an error message if you insert an incompatible SFP. For more information, please contact PHABRIX Support at: <https://www.phabrix.com/support>

SDI Inputs Using BNC Connectors (Factory-fitted Option)

Note: You need to set the Analyzer input to **Analyzer Input SDI (BNC)** using the Toolbar softkeys or the **Switch Analyzer** dialog in the Settings tab of the Setup Menus.

The Physical Layer input connection for eye and jitter is the right-most BNC connector (when viewed from the rear) fitted with a black- or red-colored nut. This provides the multirate eye and jitter connection from 270M SD-SDI to 12G HD-SDI.

The input connectors to the Analyzer have the following capabilities:

- Four 12G HD-SDI capable input BNC connectors: **SDI In A, B, C, and D.**
- One 270M SD-SDI capable input BNC connector: **SDI In A.**

Note: SDI BNC input connectors **SDI In B, C, and D** are not supported for SD-SDI input.

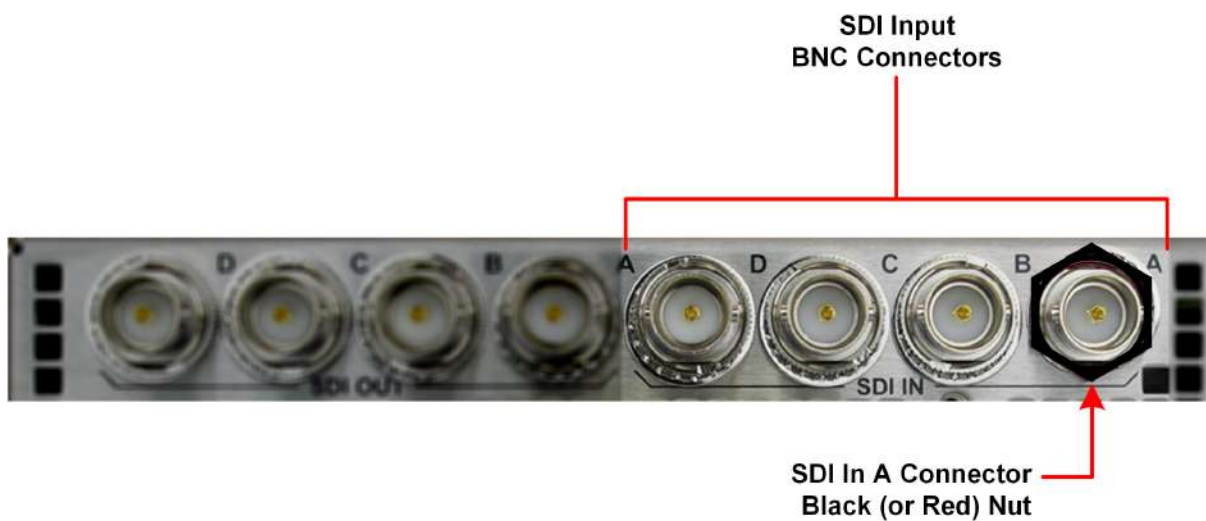

Figure 5-4: Rear Panel SDI Input BNC Connectors

Up to four HD-SDI inputs, or one SD-SDI input can be connected at any one time, however, the system will automatically determine the signal-set to analyze, whether single-, dual-, or quad-link, based on the SMPTE ST 352 packets present. The algorithm first looks to **SDI In A** and then determines the overall standard.

If the SMPTE ST 352 packets are known to be incorrect then you can select **Ignore** for the parameter **Payload Identifiers** in the **Analyzer - Video Standard (SDI & 2022-6)** instrument options menu.

SDI BNC In-to-SDI BNC Out signal pass-through is provided by selecting the **Loop SDI In A, B, C, or D** parameter in the **System IO** instrument options menu, making the SDI input signal(s) available on the corresponding SDI BNC output connector(s).

Note: For SD-SDI inputs, you can loop **SDI In A** through to **SDI Out A** only. If you attempt to loop SD-SDI through to the **SDI Out B, C, or D** connectors, the System IO instrument will display the message **No Signal** next to the corresponding BNC output connector.

For a summary of the input and output capabilities with SD-SDI and HD-SDI, see [Table 5-1](#).

SDI Outputs Using BNC Connectors (Factory Fitted Option)

You can control the output signal independently, on each of the four SDI BNC output connectors **SDI Out A, B, C, or D**, using either the **System IO** or the **Generator** instruments.

Note: You need to set the Output to **SDI** in the **Video Generator Config...** dialog.

The Generator can provide up to four SDI output signals which must form part of the same video signal-set. When you enable the **Generator Copy** mode in the **Generator** options menu it can provide any of the following, depending on the selected video standard:

- Four Single links
- Two Dual links
- One Quad link.

SDI Out A is always present and carries the first HD-SDI signal in the group, **SDI Out B** is active for dual- and quad-link HD-SDI standards, and **SDI Out C** and **SDI Out D** are active for quad-link HD-SDI standards. **SDI Out A** may also be used to loop input SD-SDI on **SDI In A** through to **SDI Out A**.

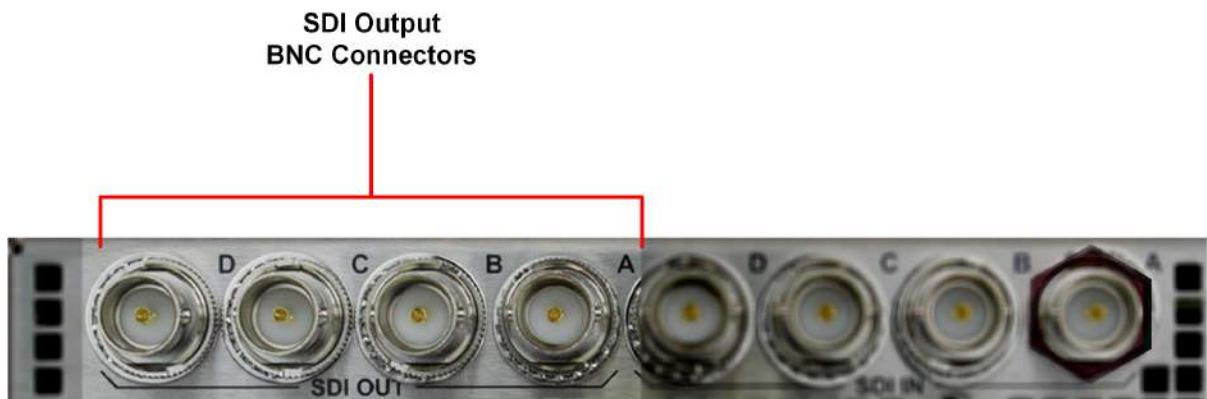

Figure 5-5: Rear Panel SDI Output BNC Connectors

For each of the four output BNC connectors, you can select from the following optional modes in the **SDI Output Assignment** submenu of the Generator instrument or from the options menu of the System IO instrument:

- **Off:** Mutes the selected SDI Out connector.
- **Generator:** If the **Generator Copy** function is also enabled, allows you to copy the HD-SDI Generator output to any unused SDI Out BNCs (A, B, C or D). The number of copies depends on the number of signals from the Generator. For example, with a single link you can have up to three copies, with a dual-link, one copy and with a quad-link, no copies as all connectors are used by the primary Generator signal.

Note: The generation of SD-SDI video standards is not currently supported.

- **Loop SDI in A, B, C, or D:** Enables you to repeat the signal presented to the SDI BNC inputs as an output from the SDI BNC Outputs. When selected, there is a direct mapping between the **SDI In** BNC connector and its corresponding **SDI Out** BNC connector, for example, **SDI In A** loops to **SDI Out A**, **SDI In B** loops to **SDI Out B**, and so on.

Note: The Loop feature is available when both the **SDI Input Source** and **SDI Out** options in the System IO instrument are both set to **BNC**.

Note: For SD-SDI inputs, you can loop **SDI In A** through to **SDI Out A** only. If you attempt to loop SD-SDI through to the **SDI Out B, C, or D** BNC connectors, the System IO instrument will display the message **No Signal** next to the corresponding BNC output connector.

If the **Generator Copy** mode is disabled in the Generator options menu, the unit generates a single instance of a link standard as follows:

- One Single-link
- One Dual-link
- One Quad-link.

Table 5-1 : Summary of SD- and HD-SDI Capabilities on BNC Input and Output Connectors

BNC Connector	SD-SDI			HD-SDI		
	SD-SDI Input	Generator Copy	Loop Through	HD-SDI Input	Generator Copy	Loop Through
Input Connectors						
SDI In A	Yes	N/A	Yes	Yes	N/A	Yes
SDI In B	No	N/A	No	Yes	N/A	Yes
SDI In C	No	N/A	No	Yes	N/A	Yes
SDI In D	No	N/A	No	Yes	N/A	Yes
Output Connectors						
SDI Out A	N/A	N/A	Yes	N/A	Yes	Yes
SDI Out B	N/A	N/A	No	N/A	Yes	Yes
SDI Out C	N/A	N/A	No	N/A	Yes	Yes
SDI Out D	N/A	N/A	No	N/A	Yes	Yes

Where: N/A = Not Applicable

Overview of SDI SFP Connections (Factory Fitted Option)

The unit has two available SFP+ cages that can be used for SDI SFPs labeled **SFP+A** and **SFP+B**. Each cage can house an SFP+ interface module that itself has one or two signal lanes. The signal lane can be either **Rx** (receiver/input) or **Tx** (transmitter/output).

Note: You need to set the Output to **SDI** in the **Video Generator Config...** dialog.

With two SDI SFPs inserted, between one to four HD-SDI input/outputs (IOs) are available. The number of IOs that are inputs (Rx) or outputs (Tx) depends on the inserted SFP types.

Note: For an SD-SDI source, the input must always be applied to **SFP+A port A**.



The unit can accept the following SFP types in both SFP+A and SFP+B slots:



- RxRx (Dual Receiver – Two Inputs)
- TxTx (Dual Transmitter – Two Outputs)
- RxTx (Transceiver – One Input, One Output)

An RxRx RxRx combination would provide up to four inputs; TxTx TxTx provides up to four outputs and so on.

The unit maps the SDI signal lane positions (A, B, C, or D) of the installed SFP to internal SDI paths as outlined in the following table. Whether a lane is an input or output depends on the type of SFP installed. The SDI SFP recommended configurations for single-, dual and quad-link use-cases with Transceivers, Dual Transmitters and Dual Receivers are as follows:

Table 5-2 : Recommended SFP / SFP Connections

SDI SFP Interface(s)	Link Type	SFP+B		SFP+A	
		 Link Rates		 Link Rates	
		Port C	Port D	Port A	Port B
Transceivers Only					
One SDI Transceiver in Cage A	SFP Interface	N/A	N/A	Rx Ch1	Tx Ch 1
	Single Link: Rx/Tx	N/A	N/A	BNC A Rx 0.27/1.5/3/6/12	BNC A Tx 1.5/3/6/12
	Dual Link: N/A	N/A	N/A	N/A	N/A
	Quad Link: N/A	N/A	N/A	N/A	N/A
Two SDI Transceivers in Cages A & B	SFP Interface	Rx Ch1	Tx Ch1	Rx Ch1	Tx Ch1
	Single Link: Rx/Tx	N/A	BNC C Tx (Tx Copy) 1.5/3/6/12	BNC A Rx 0.27/1.5/3/6/12	BNC A Tx 1.5/3/6/12
	Dual Link: Rx/Tx	BNC C Rx 1.5/3/6	BNC C Tx 1.5/3/6	BNC A Rx 1.5/3/6	BNC A Tx 1.5/3/6
	Quad Link: N/A	N/A	N/A	N/A	N/A
Dual SDI Receivers Only					
One SDI Dual Receiver in Cage	SFP Interface	N/A	N/A	Rx Ch1	Rx Ch2

SDI SFP Interface(s)	Link Type	SFP+B		SFP+A	
					
		Link Rates		Link Rates	
		Port C	Port D	Port A	Port B
A					
	Single Link: Rx	N/A	N/A	BNC A Rx 0.27/1.5/3/6/12	N/A
	Dual Link: Rx	N/A	N/A	BNC A Rx 1.5/3/6	BNC B Rx 1.5/3/6
	Quad Link: N/A	N/A	N/A	N/A	N/A
Two SDI Dual Receivers in Cages A & B	SFP Interface	Rx Ch1	Rx Ch2	Rx Ch1	Rx Ch2
	Single Link: Rx	N/A	N/A	BNC A Rx 0.27/1.5/3/6/12	N/A
	Dual Link: Rx	N/A	N/A	BNC A Rx 1.5/3/6	BNC B Rx 1.5/3/6
	Quad Link: Rx ^{(1), (2)}	BNC C Rx 1.5/3	BNC D Rx 1.5/3	BNC A Rx 1.5/3	BNC B Rx 1.5/3
Dual SDI Transmitters Only					
One SDI Dual Transmitter in Cage A	SFP Interface	N/A	N/A	Tx Ch2	Tx Ch1
	Single Link: Tx	N/A	N/A	BNC B Tx (Tx Copy) 1.5/3/6	BNC A Tx 1.5/3/6/12
	Dual Link: Tx	N/A	N/A	BNC B Tx 1.5/3/6	BNC A Tx 1.5/3/6
	Quad Link: N/A	N/A	N/A	N/A	N/A
Two SDI Dual Transmitters in Cages A & B	SFP Interface	Tx Ch2	Tx Ch1	Tx Ch2	Tx Ch1
	Single Link: Tx	BNC D Tx (Tx Copy) 1.5/3/6	BNC C Tx (Tx Copy) 1.5/3/6/12	BNC B Tx (Tx Copy) 1.5/3/6	BNC A Tx 1.5/3/6/12
	Dual Link: Tx	BNC D Tx (Tx Copy) 1.5/3/6	BNC C Tx (Tx Copy) 1.5/3/6	BNC B Tx 1.5/3/6	BNC A Tx 1.5/3/6
	Quad Link: Tx ^{(3), (4)}	BNC D Tx 1.5/3	BNC C Tx 1.5/3	BNC B Tx 1.5/3	BNC A Tx 1.5/3
Mixed Dual Transmitters and Receivers					
One SDI Dual Transmitter (Cage A) and One Dual SDI Receiver (Cage B)	SFP Interface	Rx Ch1	Rx Ch2	Tx Ch2	Tx Ch1
	Single Link: Rx/Tx	BNC C Rx 1.5/3/6/12 ⁽⁵⁾	N/A	BNC B Tx (Tx Copy) 1.5/3/6	BNC A Tx 1.5/3/6/12
	Dual Link: Rx/Tx	BNC C Rx 1.5/3/6	BNC D Rx 1.5/3/6	BNC B Tx 1.5/3/6	BNC A Tx 1.5/3/6
	Quad Link: N/A	N/A	N/A	N/A	N/A

Notes to Table:

- **(1):** In quad link 2SI the Receivers will auto-adapt to any order of sub-image to BNC mapping.
- **(2):** In quad link square division the sub-image order must be strictly followed: BNC A:TL (top left), BNC B:TR (top right), BNC C:BL (bottom left), BNC D:BR (bottom right).
- **(3):** In quad link 2SI the sub-image order is: BNC A:Sub 1, BNC B:Sub 2, BNC C:Sub 3, BNC D:Sub 4.
- **(4):** In quad link square division the sub-image order is: BNC A:TL, BNC B:TR, BNC C:BL, BNC D:BR.
- **(5):** SD-SDI (270M (0.27G)) video is not supported for Mixed Dual Transmitters and Receivers.

Note: Use only SDI SFPs approved by PHABRIX. The unit displays an error message if you insert an incompatible SFP. For more information, please contact PHABRIX Support at: www.phabrix.com/support

SDI Inputs Using SFP Connectors (Factory Fitted Option)

Note: You need to set the Analyzer input to **Analyzer Input SDI (SFP)** using the Toolbar softkeys or the **Switch Analyzer** dialog in the Settings tab of the Setup Menu.

You can use SFP+A port A as the receive (**Rx**) connection for SD-SDI or both SFP+A and SFP+B connectors as receive (**Rx**) connections for HD-SDI. Depending on the type of SDI SFP+ used, up to four HD-SDI Input connections from 1.5G HD-SDI to 12G HD-SDI are available, with the analyzer providing up to four 12G HD-SDI capable inputs.

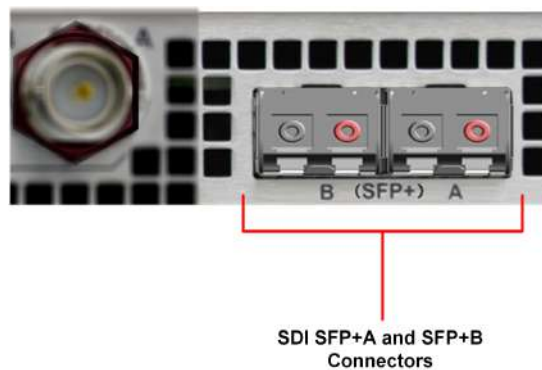

Figure 5-6: Rear Panel SDI Input SFP Connectors

Either one SD-SDI input, or up to four HD-SDI inputs, may be connected at any one time, however, the system will automatically determine the signal-set to analyze (either single-, dual-, or quad-link) based on the SMPTE ST 352 payload identifier packets present. The algorithm looks to the first available SDI input from SFP+A port A (in alphabetical order) and then determines the overall standard.

If the SMPTE ST 352 packets are known to be incorrect then you can set the parameter **Payload Identifiers to Ignored** in the options menu of the **Analyzer - Video Standard (SDI & 2022-6)** instrument.

Note: The use of SDI SFPs for Eye and Jitter analysis and the Loop signal passthrough feature is not currently supported.

SDI Outputs Using SFP Connectors (Factory-fitted Option)

Note: You need to set the Output to **SDI** in the **Video Generator Config...** dialog.

Both SFP+A and SFP+B can be used as transmit (**Tx**) connections for HD-SDI. Dependent on the SDI SFP types used, up to four SDI output connections from 1.5G HD-SDI to 12G HD-SDI are available.

Note: The transmission of SD-SDI is not currently supported.

By default, the generator internally provides four HD-SDI output signals which must form part of the same video signal-set. Even when you generate a single link standard, Generator Output Copy behavior is automatically implemented for SDI SFPs. The generator will provide either:

- Four single-links,
- Two dual-links, or
- One quad-link.

On the internal SDI output signal paths of the unit:

- A single-link HD-SDI standard is always carried on **SDI Out A**, and then repeated on **SDI Out B**, **SDI Out C**, and **SDI Out D**.
- A dual-link HD-SDI standard is always carried on **SDI Out A** and **SDI Out B**, and is then repeated on **SDI Out C** and **SDI Out D**.
- A quad-link HD-SDI standard is delivered using all four outputs: **SDI Out A**, **SDI Out B**, **SDI Out C**, and **SDI Out D**.

Whichever of these internal HD-SDI output signal paths are used as externally available HD-SDI outputs depends on the SFP types installed. For more information, contact PHABRIX Support, see the website: www.phabrix.com/support

Video Range Definitions

For information about the video signal color range as defined in the Qx Series, see the section [Video Range Definitions for the Qx Series](#).

System IO for SDI Input (Factory Fitted Option)



Overview

Due to the complexity of the UHD TV standards, PHABRIX has introduced innovative ways to display status information. The **System IO** Instrument provides a quick overview of the signal inputs and outputs connected to the unit. In addition, System IO displays the status of signal interfaces, external reference, cable length and attenuation, and connector details.

You can use this instrument to switch inputs to the analyzer between SDI (BNCs or SFPs) and IP by tapping or clicking the appropriate connector icon. You will see the active connector group highlighted with an orange border. This enables you to switch input to the Analyzer without using the Toolbar softkeys or switching to the Settings tab of the Setup Menus, see the section [Switching Between Analyzer Inputs](#).

System IO also enables you to select either BNC or SFP+ connectors for your SDI input source and outputs using the options menu. In addition, for HD-SDI BNC outputs, System IO provides a **Generator** copy output option, which is automatically enabled for SDI SFPs. Furthermore, a **Loop** function enables you to pass-through the SDI BNC input signal (SD-SDI) (**SDI In A** only) or signal(s) (HD-SDI) making them available on the **SDI BNC** output connector(s).

System IO for SDI Input

The top half of the instrument window shows a graphical view of the rear panel connectors, displaying from left to right: SDI BNC outputs, SDI BNC inputs, external reference, SFP+ (B and A) and SFP 28 (F and E). In addition, the connector icons show the active I/Os to any of the connectors) see [Figure 5-9](#) and [Figure 5-10](#).

You can click the groups of connector icons (SDI In, SFP+, and SFP 28) to switch input to the Analyzer between IP and SDI sources.

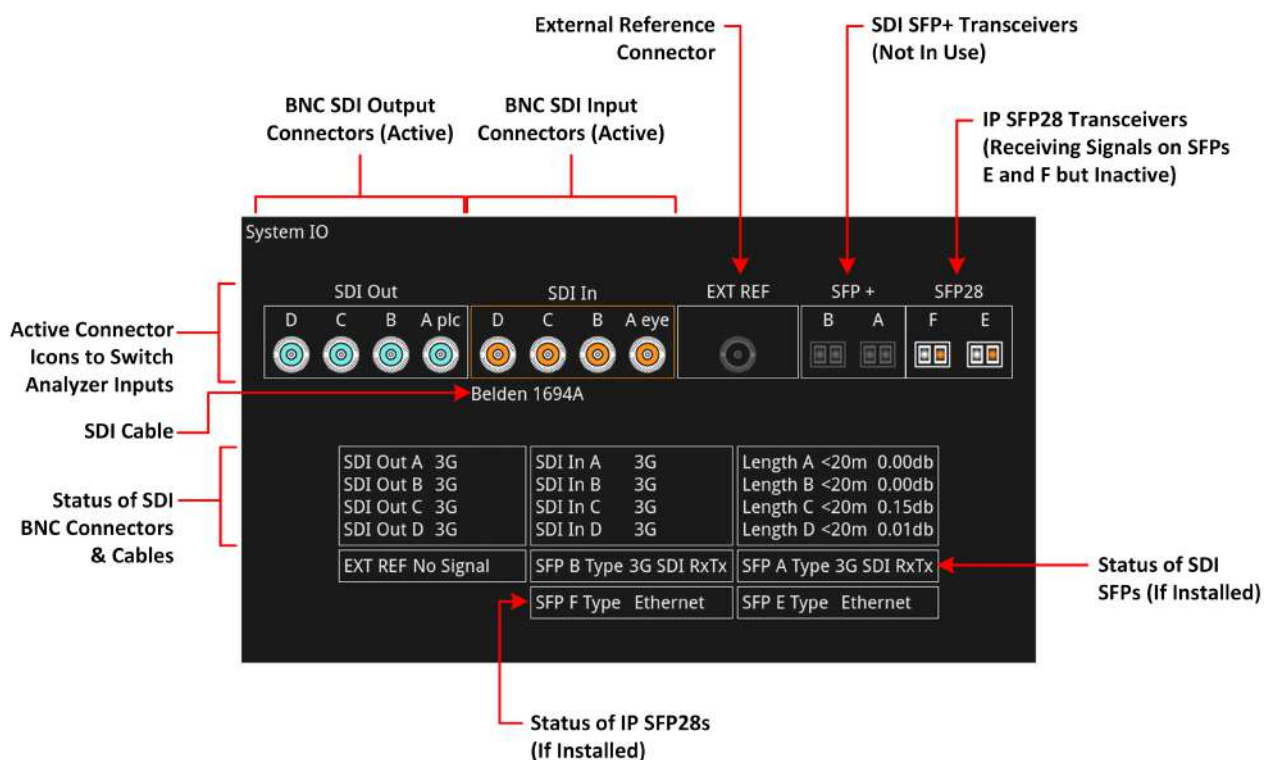

Figure 5-7: System IO Instrument Showing Analyzer Input as SDI Source

All active SDI inputs and outputs are indicated by color-coded connectors; their colors assigned by the Analyzer/Generator color scheme set in the Display Options, see the section [Instrument Launch Menu](#) for more details. An entirely grayed-out connector indicates that a signal is not present, and the previously colored ring is shown in black.

If an SDI SFP is unseated or not present, this is displayed graphically with a black void - indicating a missing SFP. IP SFPs are also displayed, if installed, and any signals to them shown as a colored icon in either of the channels. The SFPs only become active when selected, as shown by an orange border.

Note: It is only possible to loop from BNC In to BNC Out, it is *not* possible to loop from BNC to SFP, SFP to BNC, or SFP to SFP.

Instrument Menu Options

You can configure the SDI signal IO mechanism using the instrument options menu, with a choice of two SDI connector types for both input and output.

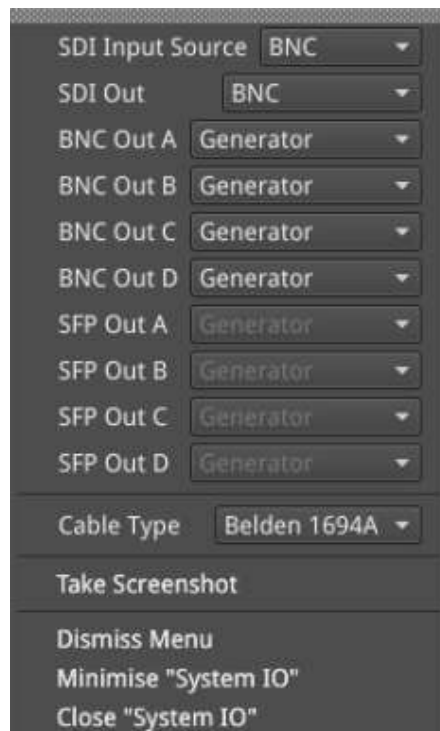

Figure 5-8: System IO Instrument - Menu Options

The following table lists the configurable parameters of the System IO instrument:

Table 5-3 : System IO Menu Options

Item	Options	Description
SDI Input Source	BNC (Default), SFP	Select the Input SDI source connector configuration you require.
SDI Out	BNC (Default), SFP	Select the Output SDI connector configuration you require.
BNC Out A BNC Out B BNC Out C BNC Out D	Off Generator (Default) Loop SDI In A (SD-SDI) Loop SDI In A (B, C, or D) (HD-SDI)	Choose whether to configure each SDI BNC Out connector (A, B, C or D) individually, to use either the Loop SDI In A (B, C, or D) signal, the Generator signal or to

Item	Options	Description
		switch off the output.
SFP Out A SFP Out B SFP Out C SFP Out D	Off Generator (Default)	Choose whether to configure each SDI SFP Out channel (A, B, C or D) individually, to use the Generator signal or to switch off the output. Note that the number of Generator Copies that you can have on an SFP depends on the number and type of SFPs that are fitted and the link format.
Cable Type	Belden 8281 Belden 1505 Belden 1694A (Default) Belden 1855A Canare L5CFB Image 1000	The selected cable type is shown below the SDI In BNC connector view

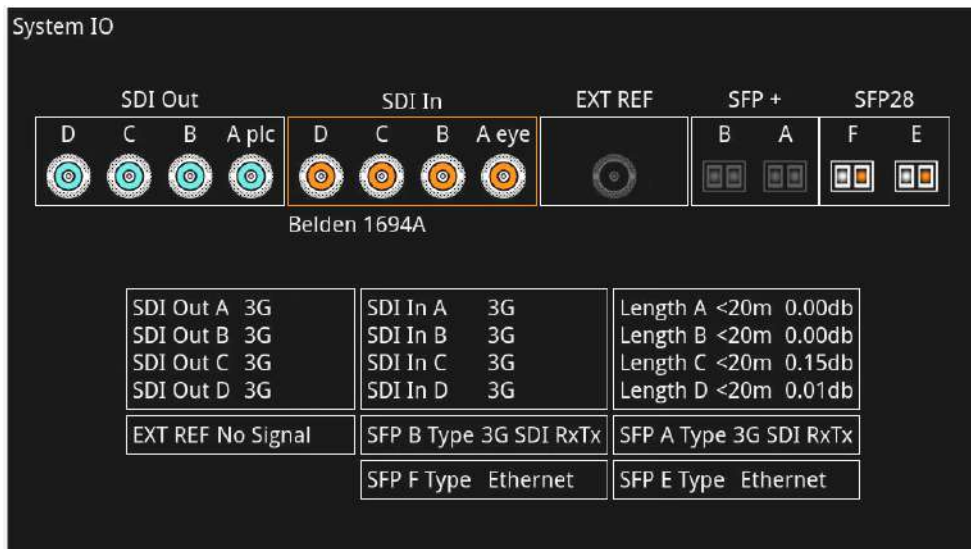

Figure 5-9: System IO Instrument Showing All 3G HD-SDI Out and HD-SDI In BNC Connectors In Use

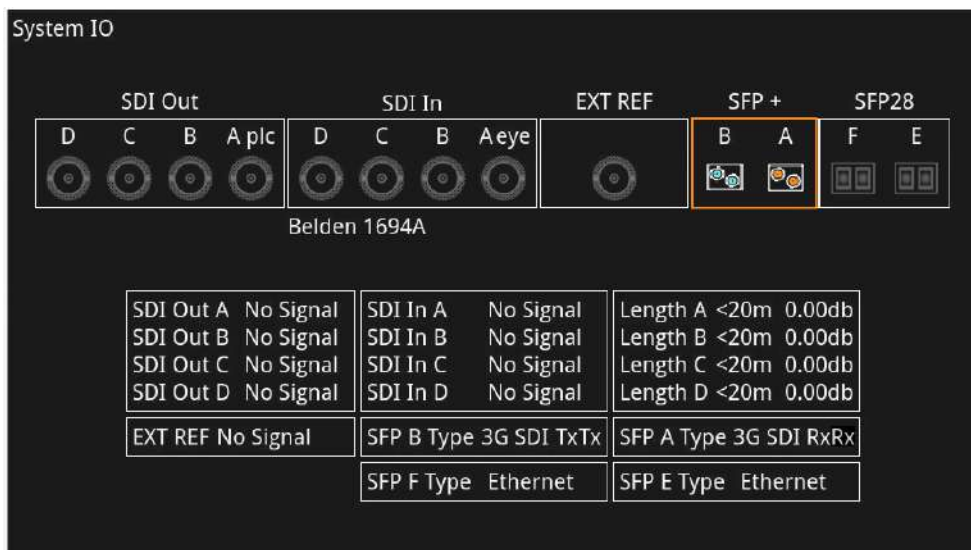

Figure 5-10: System IO Instrument Showing SFP+ Out and SFP+ In SDI Connectors In Use

Note:

BNC in / SFP out and SFP in / BNC out combinations are also supported.

For further details on SDI SFP input and output positioning, see the section [SDI SFP Connections Overview](#).

Additional SDI BNC or SFP output control is provided in the instrument options menu. The options available depend on the selected video standard and whether you are using a single-, dual- or quad-link standard.

Signals presented to the unit's SDI BNC Inputs can be repeated out on the SDI BNC or SFP outputs of the unit, by enabling the **Loop SDI In A** (SD-SDI / HD-SDI), **B**, **C**, or **D** (HD-SDI only) options for the appropriate interface connector(s).

When this Loop feature is activated, there is a one-to-one mapping between the A, B, C, and D, inputs and outputs respectively. The Loop feature disables the generator activity on the SDI BNC and overrides Output Copy.

Note: To use the Loop SDI feature, you must have either a valid SD-SDI input connected to the **SDI In A** BNC interface connector or a valid HD-SDI input connected to any of the input BNCs (for a single-link input signal.)

The Loop feature is available for BNC In / BNC Out configurations only.

To duplicate output of the generated single-link or dual-link video standard on all unused SDI Out BNCs, enable the option **Generator Copy** in the **Generator** options menu, see the following section [Generator Copy and SDI Out Configuration](#) for more information.

Note: Copying of the Generator output is not applicable to quad link standards as all outputs are used.

Note: Generator output copy functionality is automatically applied when using SDI SFP outputs.

The presence of an external reference and its standard is also displayed graphically with a colored connector. If you set the system to lock to an external reference and achieve a stable lock, then the inner ring of the EXT REF BNC ([Figure 5-10](#)) is highlighted in gray. The following EXT REF BNC colors relate to various external reference status:

- Gray (reference connected)
- Red (reference in error)
- Black (no reference connected)

Note: The EXT REF BNC shows the status of an external reference only, which is not necessarily the system reference. Overall system reference is selected in the **Video Timing & System Reference** instrument.

Below the graphical connector display, tables display input and output status, cable length and attenuation, external reference standard and status, and SFP type and presence information. You can hover the mouse over the external reference and SFP status information to display tooltips containing additional status information.

The external reference table displays the following states:

- EXT REF: [No Signal, Unstable, 525/59.94, 625/50, etc...]

If an external reference is not currently being used as system reference, its field text will display in yellow. When an external reference is the system reference, this table field text is colored white. Measurements for cable length (in meters) and attenuation (in decibels) are displayed for each SDI BNC input. The System IO instrument displays the maximum cable lengths as follows:

- SD-SDI input on BNC In A: Displays the maximum cable length as **<50m**
- HD-SDI input on BNC In A, B, C or D: Displays the maximum cable length as **<20m**.

To measure the length of a connected cable, be sure first to select the correct cable type from the instrument options menu.

Generator Copy and SDI Out Configuration

The **Generator Copy** parameter in the options menu of the **Generator** instrument allows you to enable copying of the Generator HD-SDI signal between the SDI outputs on either BNC connectors A, B, C and D, or SFP module channels A, B, C and D, depending on whether the input is single-, dual- or quad-link.

Note: The generation of SD-SDI video standards is not currently supported.

For example, you can configure the following:

- **Single input:** Three copies on **SDI Out B, C, and D**
- **Dual input:** Two copies on **SDI Out C and D**
- **Quad input:** No copies possible, all outputs used for one quad-link signal.

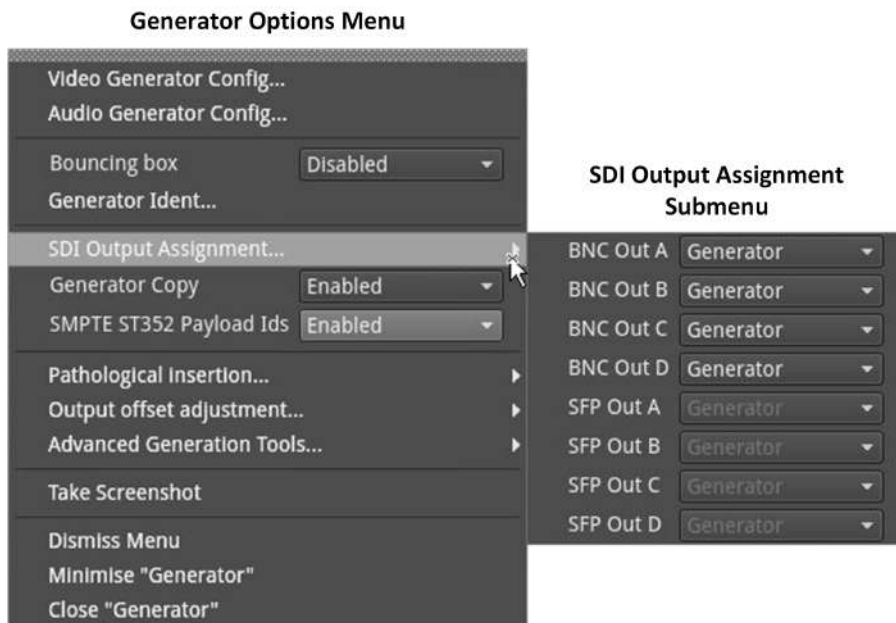

Figure 5-11: Generator Options Menu with Generator Copy Enabled

The following table lists the SDI Output Assignment options when the **Generator Copy** option is enabled in the Generator instrument options menu:

Table 5-4 : Generator Copy Menu Options

Item	Options	Description
Generator Copy Options		

Item	Options	Description
Generator Copy	Disabled (Default) Enabled	Select whether to enable or disable copying of the Generator signal to the other HD-SDI outputs.
SDI Output Assignment Options		
BNC Out A BNC Out B BNC Out C BNC Out D	Off Generator (Default) Loop SDI In A (SD-SDI) Loop SDI In A (B, C, or D) (HD-SDI)	See Table 5-3
SFP Out A SFP Out B SFP Out C SFP Out D	Off Generator (Default)	See Table 5-3

You can hover the cursor over the unselected dropdown menu to display a tooltip informing you of the current configuration of the connector. The tooltips identify both the Primary Generator and the Generator Copy or Copies as shown below:

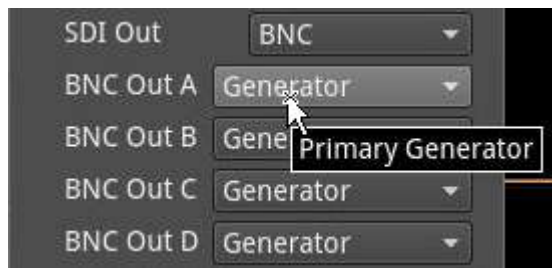

Figure 5-12: Tooltip Showing Current Configuration of Connector

When enabled in the **Generator**, you will also see the displayed status of the BNC connectors change in the **System IO** window to reflect the activity on the selected connectors.

AES IO Config (SDI (Factory Fitted Option) & ST 2022-6 IP Input/Output)



Overview

The unit provides powerful and flexible functionality for handling AES (Audio Engineering Society) input and output audio signals when present on pins 1 - 4 of the rear panel 26-way D-type connector. See the section [Technical Specifications](#) for more information on the connector pinouts. You can use a D-type to BNC converter to access the AES I/Os.

The **AES IO Config** Instrument provides a configurable gateway to the AES IO signals for SDI and ST 2022-6. You can configure the AES IO so that an audio pair from the SDI or IP 2022-6 input is routed to the four AES3 output interfaces. Encoded audio, such as AC-3, or E-AC3, can be decoded by an external third-party decoder for monitoring purposes. Encoded Dolby E™ can be decoded directly by the QxL.

The **AES IO Config** Instrument provides an interface to configure the AES I/Os as follows:

- Up to four AES signals (a combination of inputs and/or outputs) can be handled at the same time
- SDI Input to AES Output audio conversion is available for both PCM and Dolby® encoded audio (using the **Transmit - Analyser**)
- Decoded Dolby E™ input from any of the four decoded Dolby pairs, together with the down-mixed pair, can be routed out (using the **Transmit - Dolby Decoder**)
- Route AES Input signals to other AES outputs to provide a single loop output or up to three copy outputs (using **Transmit - Passthrough**).

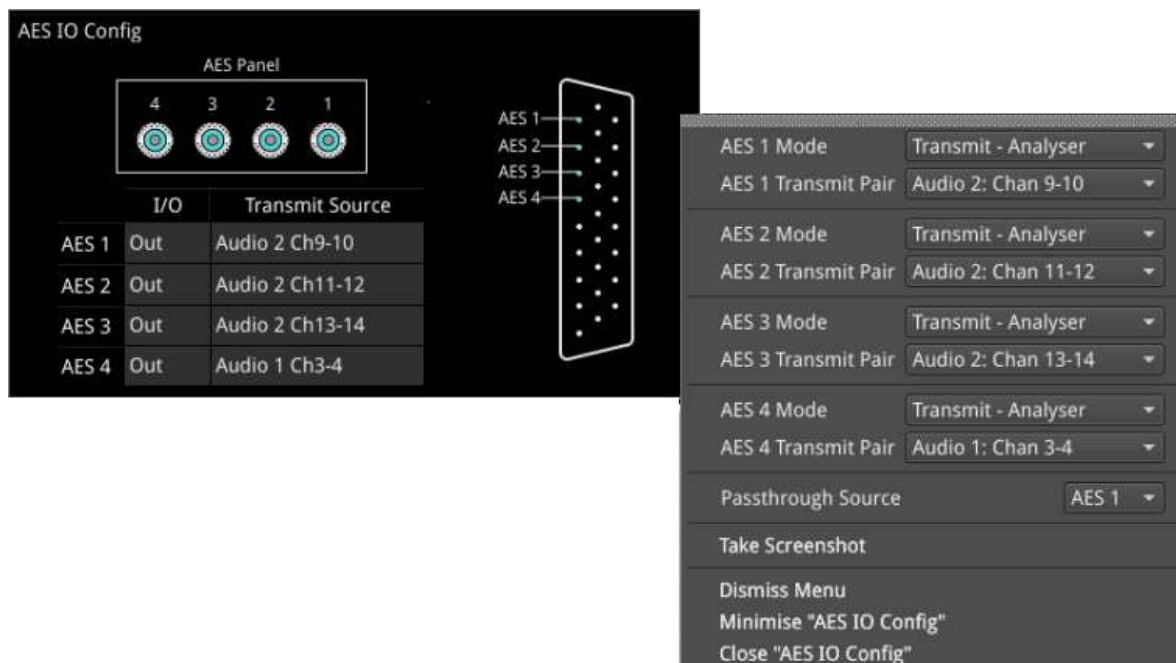

Figure 5-13: AES IO Config Instrument and Options Menu

The window provides a graphical display of the 26-way D-type rear panel connector, and labels the AES pins (pins 1 - 4). The AES Panel graphic shows the AES I/O BNCs in any AES breakout board connected to the rear panel D-type connector. In both graphics, an active AES I/O is displayed in the

Analyzer color when configured as an AES Input (in Receive mode) or in the Generator color when configured as an AES Output (in Transmit mode).

Below the AES Panel graphic, a table lists the status of each AES I/O. For AES Outputs the table also shows the transmit mode source. Any issues in the audio transmit source are highlighted in the table text as follows:

- Red: Configuration error
- Yellow: Audio source not present.

Hover the mouse over the error text to display a tooltip describing how to resolve the issue.

Instrument Menu Options

The following table lists the configurable parameters of the AES IO instrument:

Table 5-5 : AES IO Menu Options (SDI (Factory Fitted Option) and ST 2022-6 IP Input/Output)

Item	Options	Description	
SDI (Factory Fitted Option) and ST 2022-6 IP Input/Output			
AES 1 Mode	Off	AES I/O is switched off	
AES 2 Mode	Receive	Set the corresponding AES pin as an output (Transmit). The output audio signal source is the selected Group and Pair of the unit's Audio Generator, set in the Audio Generator Config... dialog of the Generator instrument. See the section: Generator (Audio) .	
AES 3 Mode	I/O is set to AES Input		
AES 4 Mode	Transmit - Generator		
	I/O is set to AES Output		
	Transmit - Analyzer		Set the corresponding AES pin as an output (Transmit). The output audio signal source is the selected Group and Pair of the selected Audio Meter. See the section: Analyzer - Audio Meters .
	I/O is set to AES Output		
	Transmit - Dolby Decoder	Set the corresponding AES pin as an output (Transmit). The output Dolby E signal source is any of the four decoded Dolby pairs, together with the downmixed pair from the Dolby Decoder. See the section: Analyzer - Audio Meters .	
	I/O is set to AES Output		
	Transmit - Passthrough	Set the corresponding AES pin as an output (Transmit)	
	I/O is set to AES Output	The output audio signal is routed from the chosen AES Passthrough Source.	
AES 1 Transmit Pair	Group 1: Pair 1, Group 1: Pair 2, Group 2: Pair 1, Group 2: Pair 2, Group 3: Pair 1, Group 3: Pair 2, Group 4: Pair 1, Group 4: Pair 2, Group 5: Pair 1, Group 5: Pair 2, Group 6: Pair 1, Group 6: Pair 2, Group 7: Pair 1, Group 7: Pair 2, Group 8: Pair 1, Group 8: Pair 2	Select the required Audio Group and Pair.	
AES 2 Transmit Pair			
AES 3 Transmit Pair			
AES 4 Transmit Pair			
Passthrough Source	AES 1, AES 2, AES 3, AES 4	Set the AES pin corresponding to the passthrough source.	

Video Timing & System Reference (SDI Input) (Factory Fitted Option)



Overview

The **Video Timing & System Reference** instrument provides measurements that enable you to assess the timing quality of the SD- or HD-SDI video input relative to a selected reference. If necessary, you can then set timing offsets against which to measure. This section covers the measurement and adjustment tools available for optional SDI input to the Analyzer.

Video Timing for SDI Input

SDI A vs System Reference

For SDI input to the Analyzer, the upper section of the **Video Timing & System Reference** instrument window compares the timing of the SD- or HD-SDI input, applied to the BNC connector **SDI IN A**, against a selected System Reference to which the unit is locked. You can select the System Reference from External, SDI, Free Run, PTP SFP E, or PTP SFP F. The upper section of the instrument displays the following resulting measurements in both spatial units (lines and pixels) and time units (μs or ns):

- Measured Timing
- Offset to Apply (with External Reference and SDI only)
- Offset Timing (with External Reference and SDI only)

You can choose to apply an Offset to the System Reference against which to measure using the options menu. When configured, the position of the Offset (Offset Position) is shown on the timing meter as a black triangle.

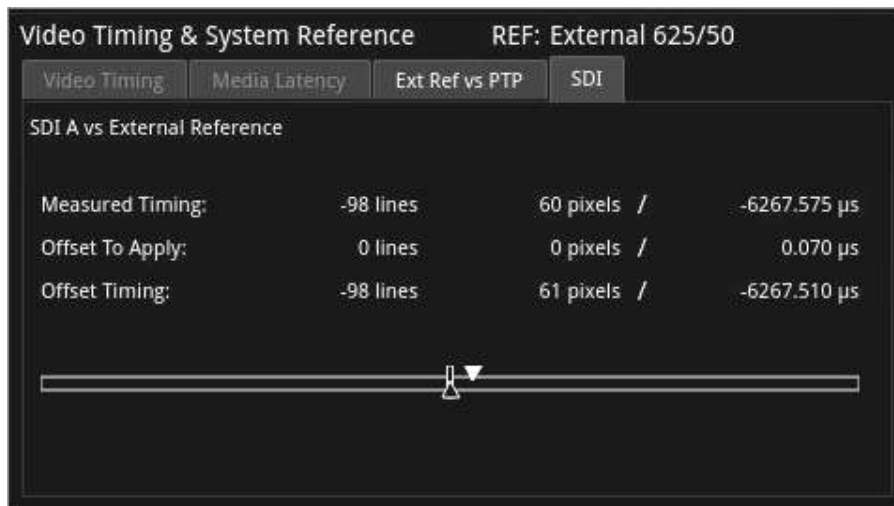

Figure 5-14: Video Timing & System Reference Instrument with SD-SDI Reference Input (SDI Input)

Note: If the license **PHQXL-IP-MEAS** is not available, the **Video Timing** tab is not displayed.

SDI Co-Timing (HD-SDI Inputs)

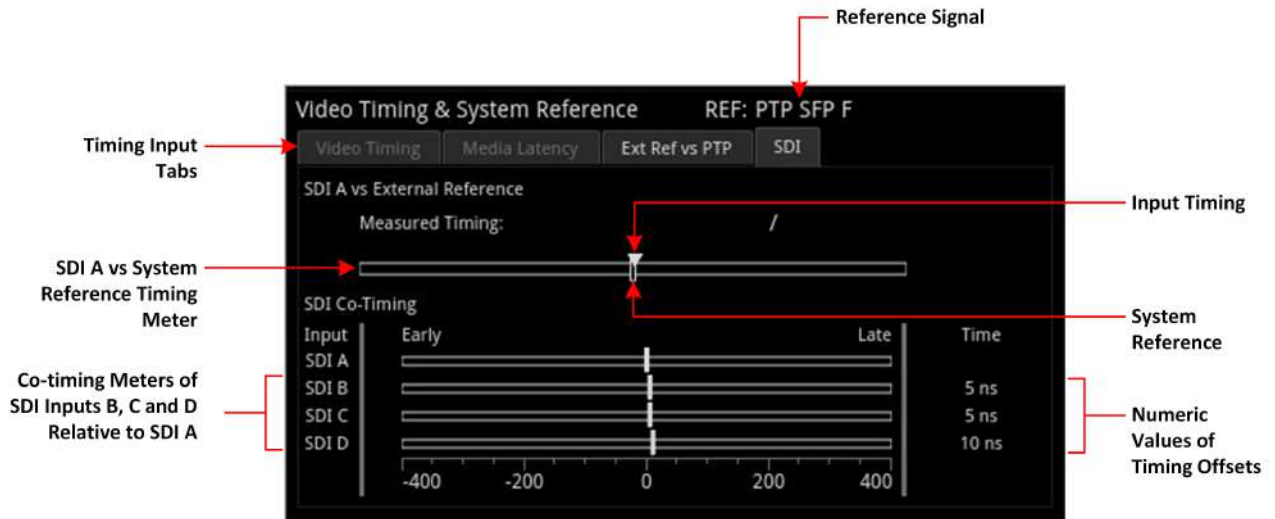

Figure 5-15: Video Timing & System Reference Instrument (SDI Input)

The lower SDI Co-Timing section of the window displays timing information for each input of a single (SDI IN A), dual (SDI IN A and B) or quad link (SDI IN A, B, C and D) HD signal. Many of the standards associated with UHDTV are a combination of signals to form the image plane. Relative timing tools indicate that the dual or quad elements creating the single picture are correctly aligned and compared with the reference. The instrument presents both graphic and numeric values for this critical measurement.

The horizontal Early / Late timing meters show whether the timing offset on each subsequent input is earlier or later than the input signal on SDI IN A. The Instrument displays the actual timing offset values in the Time column to the right of the timing meters. Early timings are show as negative values and late timings are positive. Any red text indicates a measurement outside the specification.

Note: The Timing instrument in this software release is locked to SDI Input A (SDI IN A).

Instrument Menu Options

The following table lists the configurable parameters of the Video Timing & System Reference instrument submenu:

Table 5-6 : Video Timing & System Reference Menu Options (SDI Input)

Item	Options	Description
System Reference	Free Run (Default) External Reference SDI PTP SFP E PTP SFP F	System reference locking controls define the reference to which the unit and any signal it generates is locked. By selecting the default option Free Run, the system locks to the internal oscillator as the timing reference signal. If the system loses the external or SDI reference signal for some reason, the system will automatically switch to use the Free Run reference signal. You can view system reference lock status information by hovering the cursor over the system reference in the upper-right corner of the instrument. Any error or warning conditions concerning the status of the reference are dis-

Item	Options	Description
		played in red or yellow respectively.
Ext Ref Termination	Enabled (Default) Disabled	When enabled, adds an internal 75 ohm termination to the reference input to stabilize the system reference signal.
Ext Ref Meter Range	+/- 0.1 line +/- 0.5 line (Default) +/- 0.5 frame	Adjusts the displayed range of the external reference timing meter in the upper section of the Instrument to display readings at frame scale, or to zoom in to a fraction of a line.
Input Offset Type	Lines And Pixels Time	Defines whether to apply an offset using spatial (lines / pixels) or temporal (μ s, ns) values.
Input Time Offset	0.00, +/- 0.01, etc...	For Time as the offset type, set the timing offset in microseconds (μ s).
Input Line Offset	0 to +/- (Total number of Lines in the current standard minus one.)	For Lines And Pixels as the offset type, set the coarse timing offset as a number of lines.
Input Pixel Offset	0 to +/- (Total number of Pixels per Line in the current standard minus one.)	For Lines And Pixels as the offset type, set the fine timing offset as a number of pixels.
Set Input Offset to current	System Control	Sets the input measurement offset to the same position as the current SDI In A signal.
Clear Input Offset	System Control	Removes any input measurement offset.

SFP (A, B) - Info (SDI Modes) (Factory Fitted Option)



Overview

The **SFP - Info** windows provide at-a-glance physical status information on each SFP+ module, including Identifier, Connector, line code (Encoding), Vendor details and approval status for use with the unit. More detailed status information for the SFP, such as temperature and voltage are also displayed.

SFP A - Info		Temperature: 35.3 °C Voltage: 3.25 V Rx Power: 0.58 mW Tx Power: 0.43 mW	
Vendor	Gigalight	Bit Rate (MBd)	10300
Part No	GPP-85192-SRC	Optical Wavelength (nm)	850
Vendor OUI	00-00-00	SFF 8472 Compliance	SFF 8472 Rev 9.3
Revision	1.0	Temp High Warning (°C):	80.0
Serial No	M1812270699	Temp Low Warning (°C):	-5.0
Identifier	SFP/SFP+/SFP28 and later	Temp High Alarm (°C):	85.0
Ext Identifier	GBIC/SFP function via two-wire only	Temp Low Alarm (°C):	-10.0
Connector Type	LC	Voltage High Warning(V)	3.60
Encoding	64B/66B	Voltage Low Warning (V)	3.00
10G Ethernet	10G Base-SR	Voltage High Alarm (V)	3.70
Fibre Channel Link Length	Short Distance (S)	Voltage Low Alarm (V)	2.90
Fibre Channel Technology	Shortwave Laser w/o OFC (SN)	Tx Power High Warning (mW):	1.26
Fibre Channel Transmission Media	Multimode 62.5µm (M6), Multimode ...	Tx Power Low Warning (mW):	0.13
Rate Identifier	Unspecified	Tx Power High Alarm (mW):	1.58
Supported Link Length Smf (km)	0	Tx Power Low Alarm (mW):	0.10
Supported Link Length Smf (m)	0	Rx Power High Warning (mW):	0.79
Supported Link Length OM1 (m)	300	Rx Power Low Warning (mW):	0.05
Supported Link Length OM2 (m)	300	Rx Power High Alarm (mW):	1.00
Supported Link Length OM3 (m)	0	Rx Power Low Alarm (mW):	0.04
Supported Link Length OM4 / Copper (10m / m)	0		

Figure 5-16: SFP (A, B) - Info Instrument

Instrument Menu Options

The following table lists the configurable parameters in the SFP (A, B) - Info instrument submenu:

Table 5-7 : Video Timing & System Reference Menu Options

Item	Options	Description
Power Units	mW (Default) dBm	Units displayed for SFP Rx/Tx optical power.

Signal Generation Instruments

Note: Requires the **PHQXLO-GEN** License.

This chapter describes the unit's signal generator Instruments and includes the following sections:

- [Generator Video](#)
- [Generator Audio \(ST 2022-6 IP or Optional SDI Output\)](#)
- [Generator Audio \(ST 2110 IP Output\)](#)
- [2022-6 Transmit \(SFP F\) \(ST 2022-6 IP Output\)](#)
- [2110 Transmit \(ST 2110 IP Output\)](#)

Generator (Video)



Requires Option(s):	PHQXLO-GEN
---------------------	------------

Overview

The **Generator** instrument enables you to generate the following standards, depending on the configuration of your unit:

- ST 2110 IP output
- ST 2022-6 output
- HD-SDI (Factory-fitted Option).

Note: To generate UHD and EUHD standards, you require software options **PHQXLO-UHD** and **PHQXLO-EUHD** respectively.

The generation of SD-SDI video standards is not currently supported.

The options menu of the Generator provides access to further dialogs to:

- Configure the video standard generated
- Select a test pattern for the generated output
- Configure the audio signals generated.

Each configuration method is different depending on the desired output.

Generating ST 2110 IP Output

When configured to generate **ST 2110 IP** output, the Generator displays a status overview of the current standard being generated, the selected test pattern (name and thumbnail), and information about the reference signal. The selected output type (**IP 2110**) is displayed in the title bar.



Figure 6-1: Generator Instrument (ST 2110 IP Output)

Configuring the Video Standard

To select a video standard to generate, open the options menu (see [Figure 6-13](#)) and select **Video Generator Config...** This displays a configuration dialog from which you can select the desired parameters for the standard from the following columns:

- Resolution
- Frame Packing
- Frame Rate
- Gamut
- OTF
- Sampling
- Bit Depth and Range.

Selectable parameters are displayed in a bold white font and those that do not apply are grayed-out. If you select an incompatible parameter, the column head is displayed in a **yellow** font indicating that a correction is required. Simply click the desired parameter in each of the columns to define the standard, then click **OK** to activate and close the dialog.

To change the output from the Generator, select the desired standard (SDI, 2022-6, or 2110) from the **Output** box.

Right-click anywhere in the **Generator** window to display the options menu.

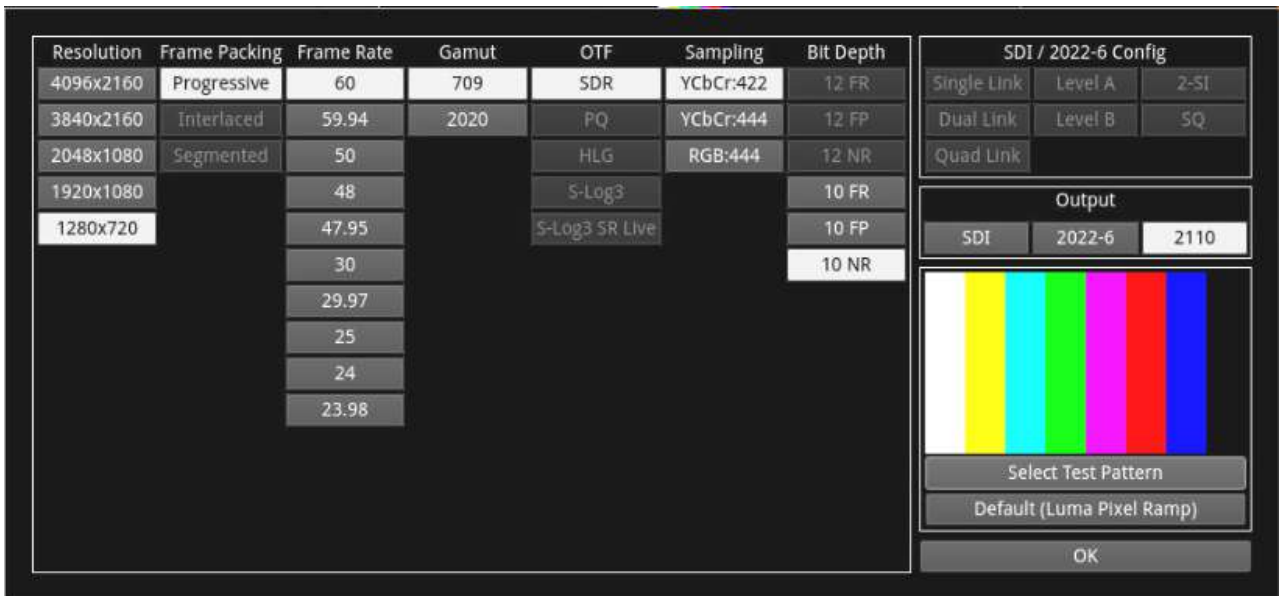

Figure 6-2: Generator Video Configuration (ST 2110 IP Output)

You can also select the default test pattern for the standard or open the Test Pattern dialog as described in the section [Generator Test Patterns](#).

Video Configuration Parameters (ST 2110 IP Output)

The unit generates video standards for a wide range of resolutions, frame rates, image mappings color gamuts, and transfer curves, depending on the available licenses. You can configure the standard to generate by selecting parameters from the following:

Table 6-1 : Generator Video Configuration Parameters (ST 2110 IP Output)

Standard Configuration	Available Parameters			
Video Standard Configuration Parameters				
Resolution	1280x720 1920x1080	2048x1080 3840x2160	4096x2160	
Frame Packing	Progressive	Interlaced	Segmented	
Frame Rate	23.98 24 25	29.97 30 47.95	48 50 59.94	60
Gamut	709	2020		
OTF	SDR PQ	HLG S-Log3	S-Log3 SR Live	
Sampling	YCbCr:422	YCbCr:444	RGB:444	
Bit Depth (and Range)	10 NR 12 FP	10 FP 12 FR	10 FR	12 NR

See the [PHABRIX](#) website for the licensing requirements to generate different video standards.

Note: The test pattern may take a few seconds to generate.

Range and Bit Depth Support for Generated Video Standards (ST 2110 IP Output)

From software version 5.4, the unit can generate video standards with either a full range (**FR**), full protected (**FP**) range, or narrow range (**NR**) bit depth for ST 2110 IP output. The Qx Series uses the definitions for Narrow, Full Protected and Full Range as defined in EBU R 103 *Video Signal Tolerance in Digital Television Systems* and SMPTE RP 2077 *Full-Range Image Mapping*.

Note: If you choose to generate a full protected range (FP) standard at 10-or 12-bit depth, pixel data is clipped from the full range standard, rather than scaled, as defined in SMPTE RP 2077.

When you choose to generate a full- or full-protected-range video standard, the Generator window displays either **FR** or **FP** respectively, alongside the bit depth label in the Video standard definition, see [Figure 6-3](#). If either FR or FP are not displayed, then the generated standard is narrow range.

12 Bit, Full Range:

Video standard 4096x2160 p 50 YCbCr:422 12 FR BT709 SDR

12 Bit, Full Protected Range:

Video standard 4096x2160 p 50 YCbCr:422 12 FP BT709 SDR

12 Bit, Narrow Range

Video standard 4096x2160 p 50 YCbCr:422 12 BT709 SDR

Figure 6-3: Generator Bit Depth Labels (ST 2110 IP Output)

For more information on video signal range definitions as implemented in the Qx Series, see the section [Video Range Definitions for the Qx Series](#).

Generating ST 2022-6 IP Output

When configured to generate **ST 2022-6** IP output, the Generator displays a status overview of the following:

- Details of the current video standard being generated
- Test pattern and description
- Whether pathological insertion is enabled and if so details of the pairs to insert
- Output type and image mapping on **SFP F**
- Audio signal presence and sub-images
- Reference status.

The selected output type (**IP 2022-6**) is displayed in the title bar.

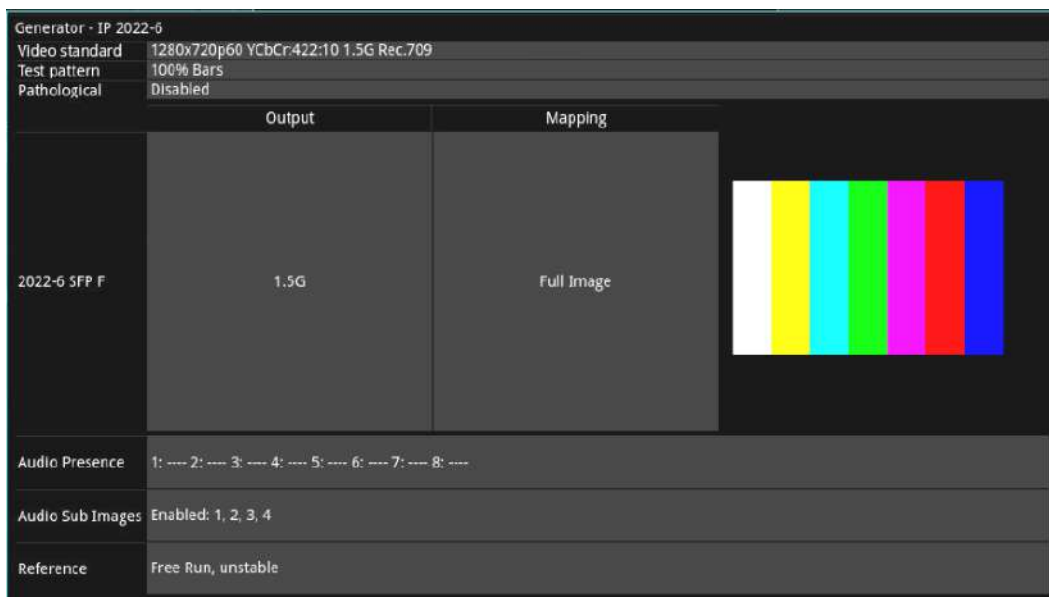

Figure 6-4: Generate - Video Instrument (ST 2022-6 IP Output)

When you generate a pathological overlay in the **Generator**, the unit detects this and displays the number of pathological events generated per second in the **Pathological** field. As one pathological event is created per line, this also indicates the number of lines per second on which pathological conditions occur on the interface. The detection of a pathological condition is available as a GPI output from the unit for use in triggering an external analyzer device.

Configuring the Video Standard

To select a video standard to generate, open the options menu (see [Figure 6-13](#)) and select **Video Generator Config...** This displays a configuration dialog from which you can select the desired parameters for the standard from the following columns:

- Resolution
- Frame Packing
- Frame Rate
- Gamut
- OTF
- Sampling
- Bit Depth and Range.

In addition the **SDI / 2022-6 Config** box in the top-right of the screen enables you to set the SDI output to Level A (single link) or Level B (dual link) as required.

Note: The parameters selected in the Video Configuration dialog must be within the supported range of the standard (ST 2022-6 in this case) before the **2022-6** Output switch becomes active for selection. Otherwise it is grayed-out or inactive.

Selectable parameters are displayed in a bold white font and those that do not apply are grayed-out. If you select an incompatible parameter, the column head is displayed in a **yellow** font indicating that a correction is required. Simply click the desired parameter in each of the columns to define the standard, then click **OK** to activate and close the dialog.

To change the output from the Generator, select the desired standard (SDI, 2022-6, or 2110) from the **Output** box.

Right-click anywhere in the **Generator** window to display the options menu.

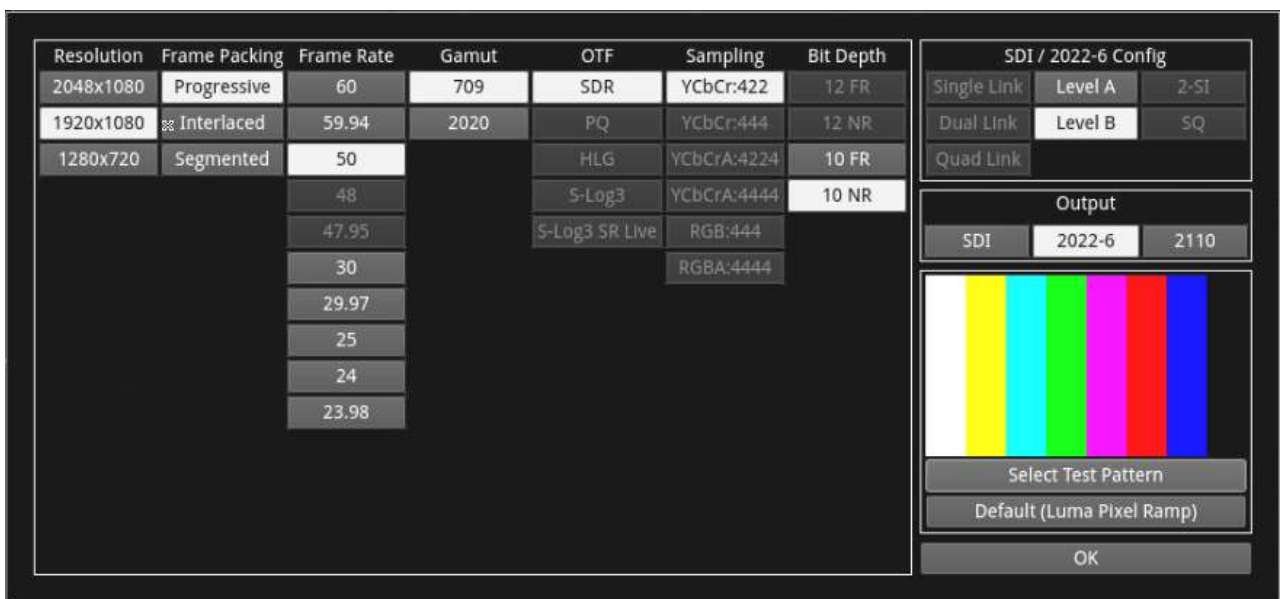

Figure 6-5: Generator Video Configuration (ST 2022-6 IP Output)

You can also select the default test pattern for the standard or open the Test Pattern dialog as described in the section [Generator Test Patterns](#).

Video Configuration Parameters (ST 2022-6 IP Output)

The unit generates video standards for a wide range of resolutions, frame rates, image mappings color gamuts, and transfer curves, depending on the available licenses. You can configure the standard to generate by selecting parameters from the following:

Table 6-2 : Generator Video Configuration Parameters (ST 2022-6 IP Output)

Standard Configuration	Available Parameters			
Video Standard Configuration Parameters				
Resolution	1280x720 1920x1080	2048x1080		
Frame Packing	Progressive	Interlaced	Segmented	
Frame Rate	23.98 24 25	29.97 30 47.95	48 50 59.94	60

Standard Configuration	Available Parameters			
Gamut	709	2020		
OTF	SDR PQ	HLG S-Log3	S-Log3 SR Live	
Sampling	YCbCr:422 YCbCr:444	YCbCrA:4224 YCbCrA:4444	RGB:444 RGBA:4444	
Bit Depth (and Range)	10 NR	10 FR	12 NR	12 FR
SDI Output Options				
SDI Output Level	Level A	Level B		

Refer to the [PHABRIX](#) website for the licensing requirements to generate different video standards.

Note: The test pattern may take a few seconds to generate.

Range and Bit Depth Support for Generated Video Standards (ST 2022-6 IP Output)

From software version 5.4, the unit can generate video standards with either a full range (**FR**) or narrow range (**NR**) bit depth for ST 2022-6 IP output. The Qx Series uses the definitions for Narrow, Full Protected and Full Range as defined in EBU R 103 *Video Signal Tolerance in Digital Television Systems* and SMPTE RP 2077 *Full-Range Image Mapping*.

Note: When you choose to generate a full range standard (either **10 FR** or **12 FR**) for ST 2022-6 IP output, the generated video is always *clipped* to protected range, rather than scaled, as defined in SMPTE RP 2077.

For a full-range video standard, the Generator window displays **FR** alongside the bit depth label in the Video standard definition, see [Figure 6-3](#): If FR is not displayed, then the generated standard is narrow range.



Figure 6-6: Generator Bit Depth Labels (ST 2022-6 IP Output)

For more information on video signal range definitions as implemented in the Qx Series, see the section [Video Range Definitions for the Qx Series](#).

Generating SDI Output (Factory Fitted Option)

Note: The generation of SD-SDI video is not currently supported in this software version.

When your unit is configured to generate **SDI** output, the Generator displays a status overview of the following:

- Details of the current video standard being generated
- Test pattern and description
- Status of pathological insertion and, if enabled, details of the pairs to insert
- HD-SDI output and mappings on **SDI Out A, B, C** and **D**
- Audio signal presence and sub-images
- Reference status
- Output Offset adjustment
- Status of Jitter insertion mode (requires Advanced Generation Tools in option **PHQXLO-SDI-STRESS**).

The selected output type (**SDI**) is displayed in the title bar.

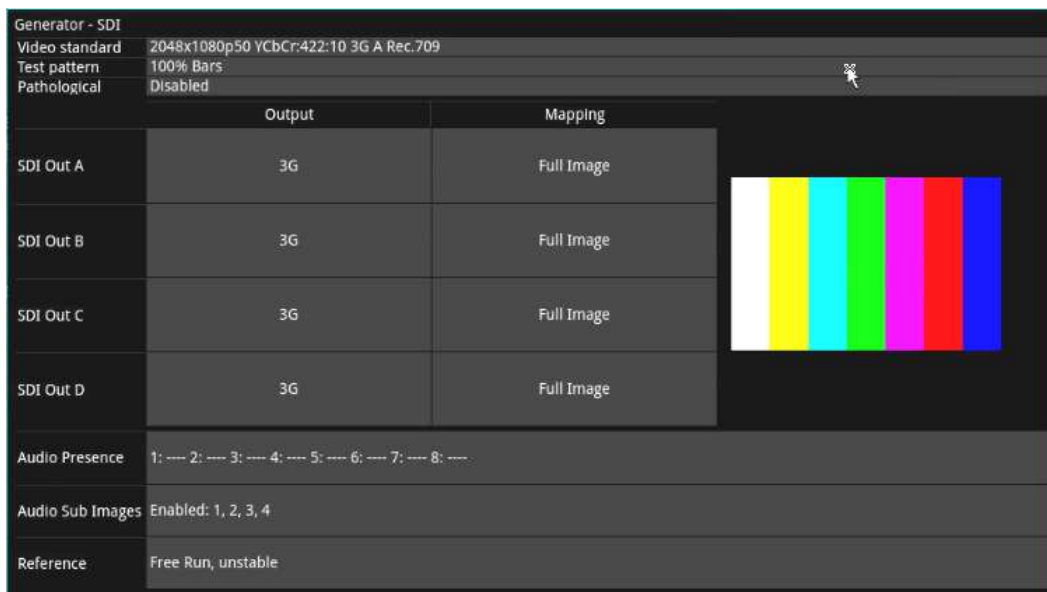

Figure 6-7: Generator Instrument (SDI Output (Factory-fitted Option))

When you generate a pathological overlay in the **Generator**, the unit detects this for all HD-SDI outputs. The unit displays the number of pathological events generated per second in the **Pathological** field. As one pathological event is created per line this also indicates the number of lines per second on which pathological conditions occur on the interface. The detection of a pathological condition is available as a GPI output from the unit for use in triggering an external analyzer device.

Note: Pathological Rate(s) counters are not displayed in PRBS Mode.

Configuring the Video Standard

To select a video standard to generate, open the options menu (see [Figure 6-13](#)) and select **Video Generator Config...** This displays a configuration dialog from which you can select the desired parameters for the standard from the following columns:

- Resolution
- Frame Packing
- Frame Rate
- Gamut
- OTF
- Sampling
- Bit Depth and Range.

In addition, the **SDI / 2022-6 Output** box in the top-right of the screen enables you to set the HD-SDI output to Level A or Level B, set either single, dual or quad link and for UHD 4K select either 2-SI (Two Sample Interleave) or SQ (Square Division).

Selectable parameters are displayed in a bold white font and those that do not apply are grayed-out. If you select an incompatible parameter, the column head is displayed in a **yellow** font indicating that a correction is required. Simply click the desired parameter in each of the columns to define the standard, then click **OK** to activate and close the dialog. You can also select the default test pattern for the standard or open the Test Pattern dialog as described in the section [Generator Test Patterns](#).

To change the output from the Generator, select the desired standard (SDI, 2022-6, or 2110) from the **Output** box.

Right-click anywhere in the **Generator** window to display the options menu.

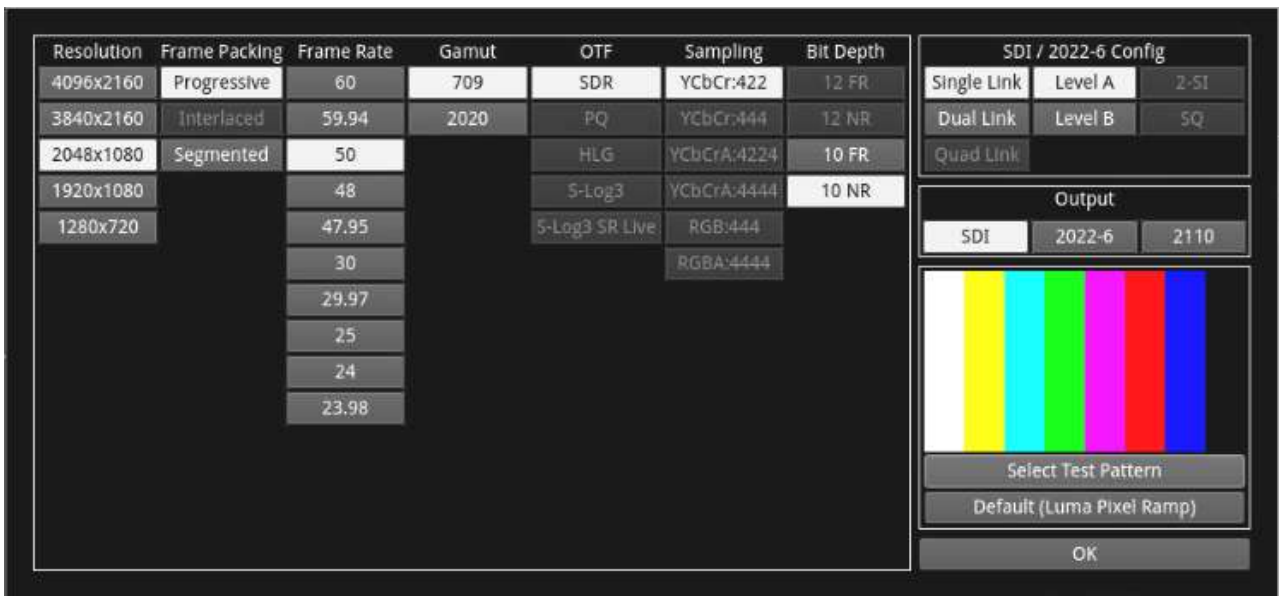

Figure 6-8: Generator Video Configuration (SDI Output (Factory-fitted Option))

For SDI output (Factory Fitted Option) and with the Advanced SDI Stress Toolset option [**PHQXLO-SDI-STRESS**], the Generator options menu includes additional Advanced Generation tools.

Note: The test pattern may take a few seconds to generate.

Video Configuration Parameters (SDI Output (Factory-fitted Option))

The unit generates video standards for a wide range of HD-SDI rates, resolutions, frame rates, image mappings color gamuts, and transfer curves, depending on the available licenses. You can configure the standard to generate by selecting available parameters from the following:

Table 6-3 : Generator Video Configuration Parameters (SDI Output (Factory-fitted Option))

Standard Configuration	Available Parameters			
Video Standard Configuration Parameters				
Resolution	1280x720 1920x1080	2048x1080 3840x2160	4096x2160	
Frame Packing	Progressive	Interlaced	Segmented	
Frame Rate	23.98 24 25	29.97 30 47.95	48 50 59.94	60
Gamut	709	2020		
OTF	SDR PQ	HLG S-Log3	S-Log3 SR Live	
Sampling	YCbCr:422 YCbCr:444	YCbCrA:4224 YCbCrA:4444	RGB:444 RGBA:4444	
Bit Depth (and Range)	10 NR	10 FR	12 NR	12 FR
SDI Output Options				
Link Type	Single Link	Dual Link	Quad Link	
SDI Output Level	Level A	Level B		
Quad Processing Type	2-SI	SQ		

Refer to the [PHABRIX](#) website for the licensing requirements to generate different video standards.

Right-click anywhere in the **Generator** window to display the options menu.

Note: The test pattern may take a few seconds to generate.

Range and Bit Depth Support for Generated Video Standards (Optional SDI Output)

From software version 5.4, the unit can generate video standards with either a full range (**FR**) or narrow range (**NR**) bit depth for optional SDI output. The Qx Series uses the definitions for Narrow, Full Protected and Full Range as defined in EBU R 103 *Video Signal Tolerance in Digital Television Systems* and SMPTE RP 2077 *Full-Range Image Mapping*.

Note: When you choose to generate a full range standard (either **10 FR** or **12 FR**) for optional SDI output, the generated video is always *clipped* to full protected range, rather than scaled, as defined in SMPTE RP 2077.

For a full range video standard, the Generator window displays **FR** alongside the bit depth label in the Video standard definition, see [Figure 6-3](#): If FR is not displayed, then the generated standard is narrow range.

12 Bit, Full Range:

Video standard 4096x2160 p 50 YCbCr:422:12 FR BT709 SDR

12 Bit, Narrow Range

Video standard 4096x2160 p 50 YCbCr:422:12 BT709 SDR

Figure 6-9: Generator Bit Depth Labels (Optional SDI Output)

For more information on video signal range definitions as implemented in the Qx Series, see the section [Video Range Definitions for the Qx Series](#).

Generator Test Patterns

To select a test pattern for the standard from the Test Pattern dialog, open the Generator options menu then select either:

- **Test Pattern Config...** or
- **Video Generator Config...** then **Select Test Pattern**.

The Test Pattern dialog displays all test patterns available for the selected video standard and provides two tabs as follows:

- **System Patterns:** Lists standard test patterns supplied with the unit.
- **User Patterns:** Lists any user-defined test patterns loaded into the folder `/home/transfer/userTestPatterns` of the unit by the user.

Note: The test patterns available can vary depending on the video standard selected in the Generator.

Click the required test pattern to select, then click **OK** to close the dialog.

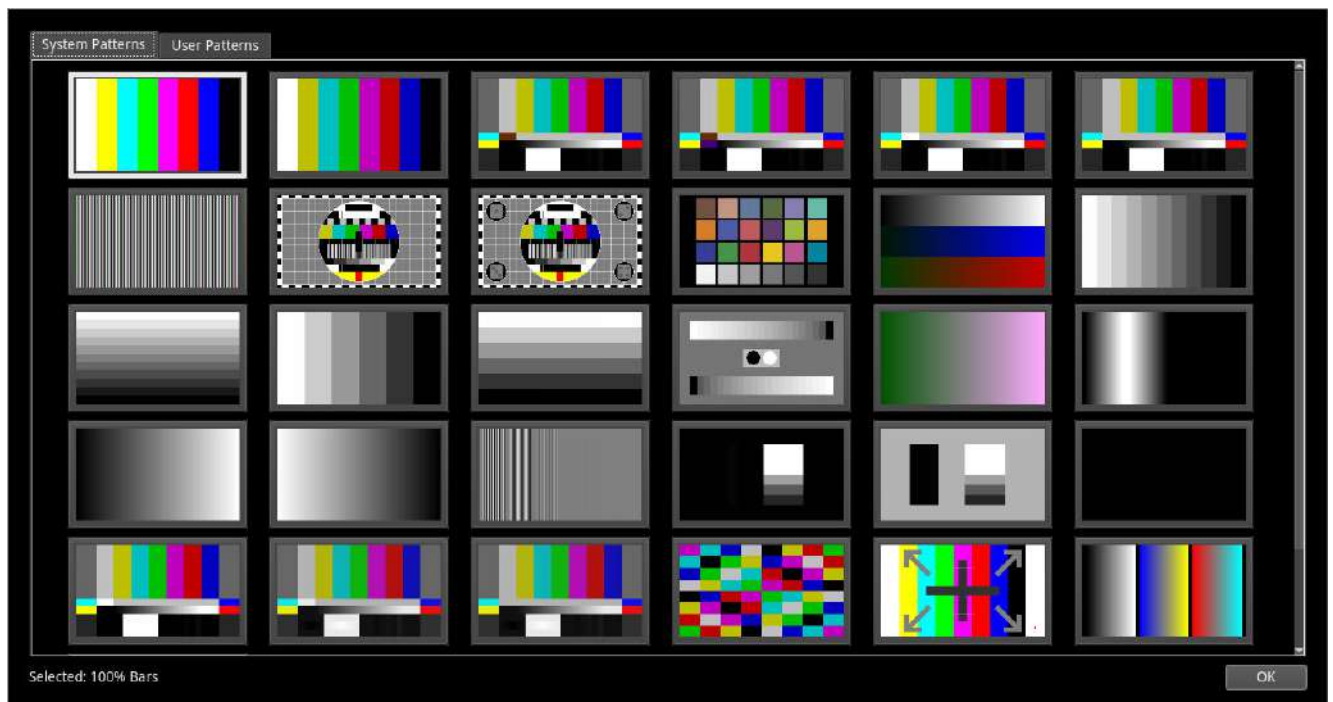

Figure 6-10: Generator - Test Pattern Selection Dialog

The first time you select a test pattern, you may notice a slight delay as the unit generates the test pattern and stores it to: **/home/transfer/testpatterns**. In particular, you may notice a delay with the larger test patterns: Gray Steps, Vertical Luma Ramp, UHD Quad Align, Circle and Circle 2si Numbers. The next time you load that test pattern the unit loads it directly from the cache with no observable delay.

These test patterns include:

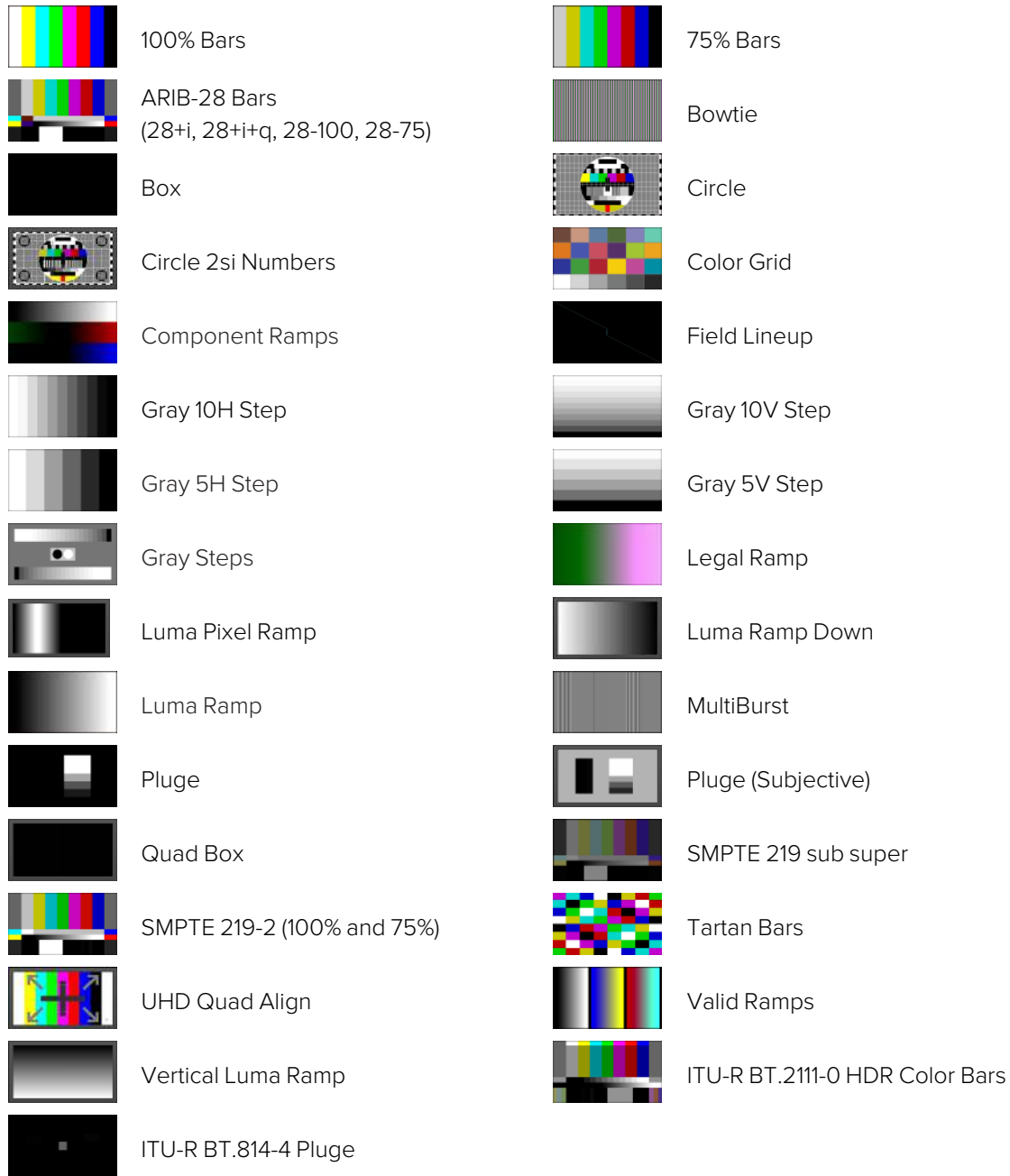

Figure 6-11: Available Generator Test Patterns

HLG, PQ and both S-Log3 and S-Log3 SR Live (HDR Live) test pattern variants are available as part of the **PHQXLO-HDR** license.

To use a moving test pattern, you can choose to overlay a bouncing box on top of any Generator test pattern. To do so, enable the **Bouncing box** parameter in the options menu.

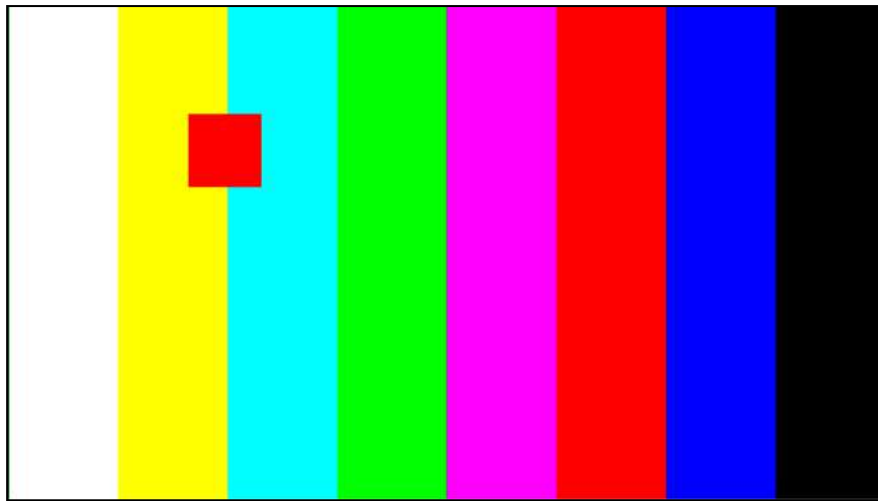

Figure 6-12: Bouncing Box Test Pattern Enabled

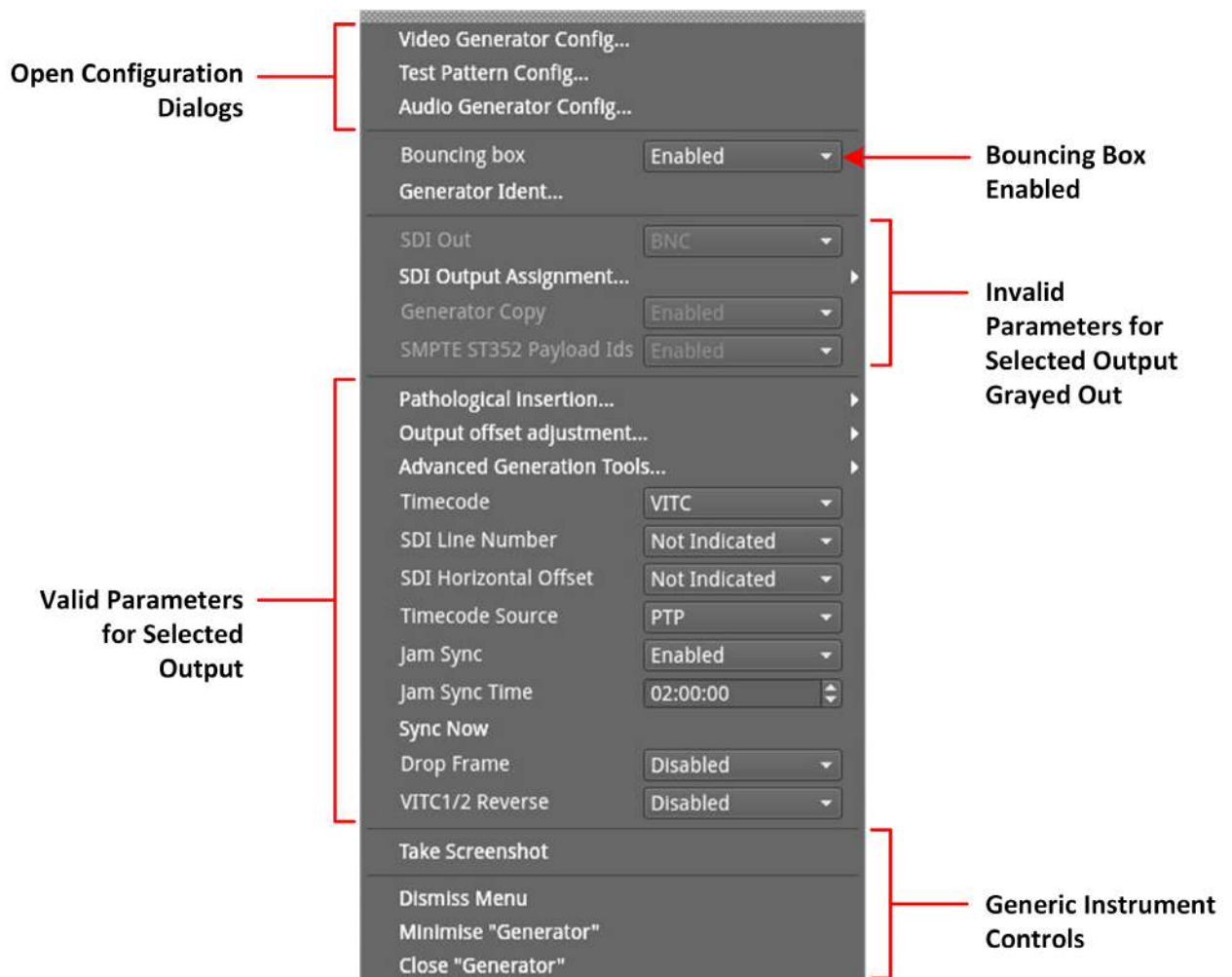

Figure 6-13: Generator - Configuration Options Menu (ST 2110 IP Output)

Including a Generator Text Identifier

You can define a text identifier (or **Ident**) to overlay on the video standard generated by the Generator and displayed in the Picture or Picture - Copy instruments for all output types. An Ident can be useful to identify the source of the generated standard.

You can enter up to four lines of text, with a maximum of 42 characters in each line. In addition, you can select one of nine positions on the Picture instrument window in which to display the Ident panel, from top-left to bottom right.

To include a text Ident, open the Generator options menu then select **Generator Ident...** to display the Generator Ident dialog.

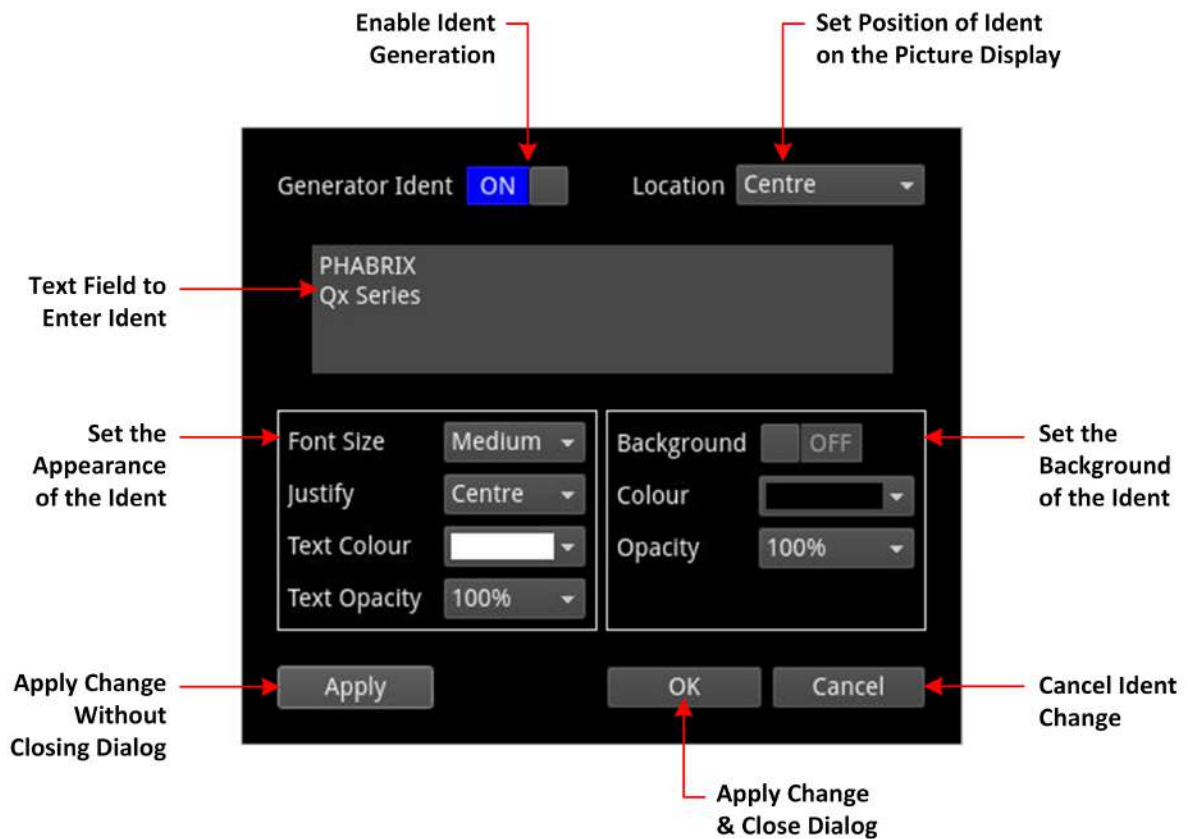

Figure 6-14: Generator - Generator Ident Dialog

Define an Ident as follows:

1. Set the **Generator Ident** toggle switch to **ON** to enable the Ident.
2. Choose where you would like the Ident displayed in the Picture or Picture - Copy window from the **Location** dropdown.

You can choose either:

- Top Left
 - Top
 - Top Right
 - Left
 - Center
 - Right
 - Bottom Left
 - Bottom
 - Bottom Right
3. Click the cursor in the Ident text entry field.

If enabled in the Display Options, the onscreen keyboard is displayed. Alternatively, either use a USB keyboard connected to the unit or the keyboard connected to the PC from which you are running a remote noVNC session.

Note: If using the onscreen keyboard, remember to click **Save** after entering the Ident text to save your changes back to the Generator Ident dialog.

4. Set the appearance attributes of the text - that is, the appearance of the text in the Ident panel.

You can set either:

- **Font Size:** Small, Medium, Large
- **Justify:** Left, Center, Right
- **Text Color:** Select from the color picker by clicking the mouse cursor anywhere in the color panel. If you need to refine your selection, use the mouse scroll wheel for numeric entry in the RGB HSV fields.

Note: The selected text (and background) color may change depending on the gamut and transfer function (OTF) selected for the generated video standard.

- **Text Opacity:** 25%, 50%, 75%, 100%

5. Set the background attributes of the Ident panel:

You can set either:

- **Background:** On, Off
- **Background Color:** Select from the color picker by clicking the mouse cursor anywhere in the color panel. If you need to refine your selection, use the mouse scroll wheel for numeric entry in the RGB HSV fields.

Note: The color lightness value (V) component of the background color is set to zero (black) by default when you select a color in the hue / saturation panel. To change the color of the background from black, select a lightness value in the Value sidebar at the right-hand side of the color picker. You will see the number change from zero in the **Value (V)** field to show the changed background color. For more information see the section [Using the Color Picker](#).

- **Background Opacity:** 25%, 50%, 75%, 100%

6. Click either **Apply** to review your changes while keeping the Generator Ident dialog open, or **OK** to save your changes and close the dialog.

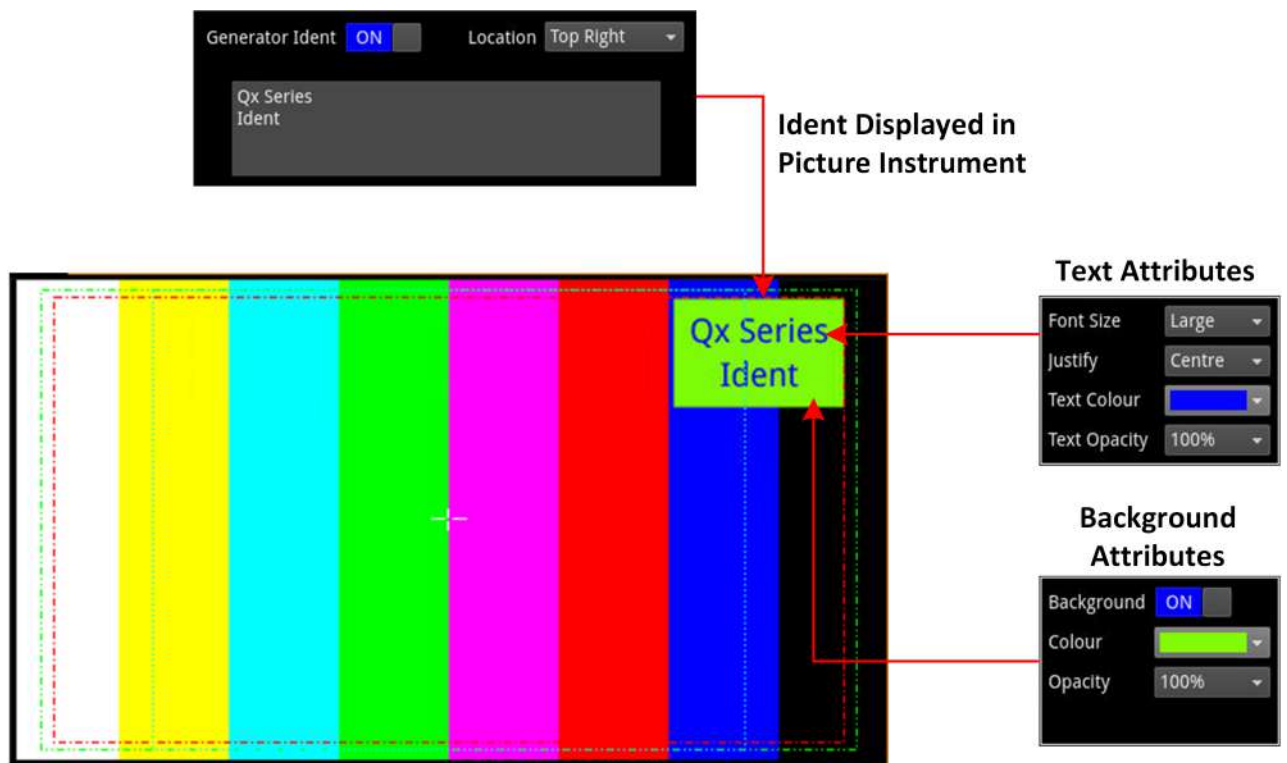

Figure 6-15: Generator Ident Displayed in Picture Instrument

User Test Patterns and Images

You can upload your own, custom test images to the unit if required.

Note: User test files must be in the Tagged Image File Format (**TIFF**) and match the exact parameters (pixel resolution, frame packing, field / frame rate, gamut, sampling, and bit depth) of the video standard you intend to use. If these conditions are not satisfied, the user test pattern will not be displayed in the **User Patterns** tab of the Test pattern selection dialog.

The specifications for user test files are detailed below:

Table 6-4 : Required Format of User Test Pattern Images

Format	Type	Extension	Pixel Resolutions	Bit Depth	Pixel Order
TIFF	Native (Files converted to TIFF from other formats are not supported)	.tif	1280 x 720 1920 x 1080 2048 x 1080 3840 x 2160 4096 x 2160	16 per RGB Component, 48 per Pixel	Interleaved

Note: Full range TIFF image files are clipped to full protect range; no scaling is applied.

If you have direct access to the unit, you can upload user test files using the [USB File Manager](#). If you have only remote access to the unit, use noVNC or SFTP to upload test files as described in the section [Remote Connection to the Unit](#).

Upload user test files to the **transfer/userTestPatterns** directory and then restart the unit.

User test images will then be available in the **User Patterns** tab of the Generator **Test pattern selection** dialog as long as the correct standard is selected in the Generator.

Using the Timecode Generator (ST 2110 IP Output)

The Timecode Generator provides a method to generate ATC Timecode in the ANC data-space according to SMPTE ST 12-2. This can then be inserted into the 2110-40 generator flow using the configuration dialog of the **2110 Transmit** Instrument, see the section [Configuring the Generator ANC Flows](#).

You can choose to generate a timecode locked either to PTP or to the local system time. You can also configure the generated timecode to include associated non-integer frame rate drop-frame, and status signaling.

You can enable or disable the Timecode in the Generator ANC Flow configuration dialog of the **2110 Transmit** instrument.

Configure the Timecode Generator parameters using the **Generator** options menu:

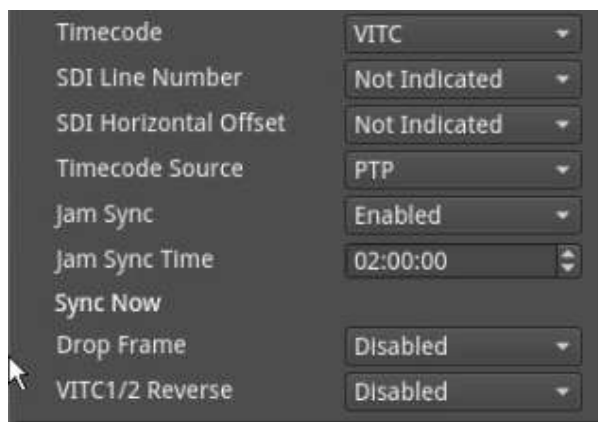

Figure 6-16: ATC Timecode Parameters in the Generator Options Menu (ST 2110 IP Output)

Table 6-5 : Generator - Timecode Generator Menu Options (ST 2110 IP Output)

Item	Options	Description
Timecode Generator Options (ST 2110 IP Output)		
Timecode	LTC VITC	Select either SMPTE Linear timecode (LTC) or SMPTE Vertical Interval Timecode (VITC).
SDI Line Number	SDI Default Not Indicated	Set the SDI line location of the ancillary packet
SDI Horizontal Offset	SDI Default Not Indicated	Set the horizontal offset for the VITC timecode in the ANC data.
Timecode Source	PTP Local Time	When available, select PTP to generate a timecode locked to the PTP signal. Select Local Time to use the local system time with current offsets for local time zone and daylight-saving time.
Jam Sync	Enabled Disabled (Default)	When enabled, automatically forces synchronization of the Timecode Generator at a predefined time.
Jam Sync Time	System Control 00:00:00 to 23:59:59	Time at which the Jam Sync is initiated when the Jam Sync option is enabled.
Sync Now	System Control	Use this control to sync the timecode manually.

Item	Options	Description
Drop Frame	Enabled Disabled (Default)	When enabled, supports drop frame rates of 29.9 and 59.9
VITC 1/2 Reverse	Enabled Disabled (Default)	For progressive frame rates above 30 Hz, enables you to select whether VITC1 is on first field and VITC2 is on the second field or to reverse the setting so that VITC2 is on the first field and VITC1 is on the second field.

The Timecode Generator is synchronized on the following events:

- On frame rate changes
- When PTP is re-synced
- When the **Jam Sync** option is enabled, once a day at the specified **Jam Sync Time**.
- When you select **Sync Now** to synchronize the Timecode Generator manually.

Generator SDI Output Assignment (Optional SDI Output)

To assign SDI outputs to the BNC or SFP Out connectors, you can use the **SDI Output Assignment...** submenu from the Generator options menu:

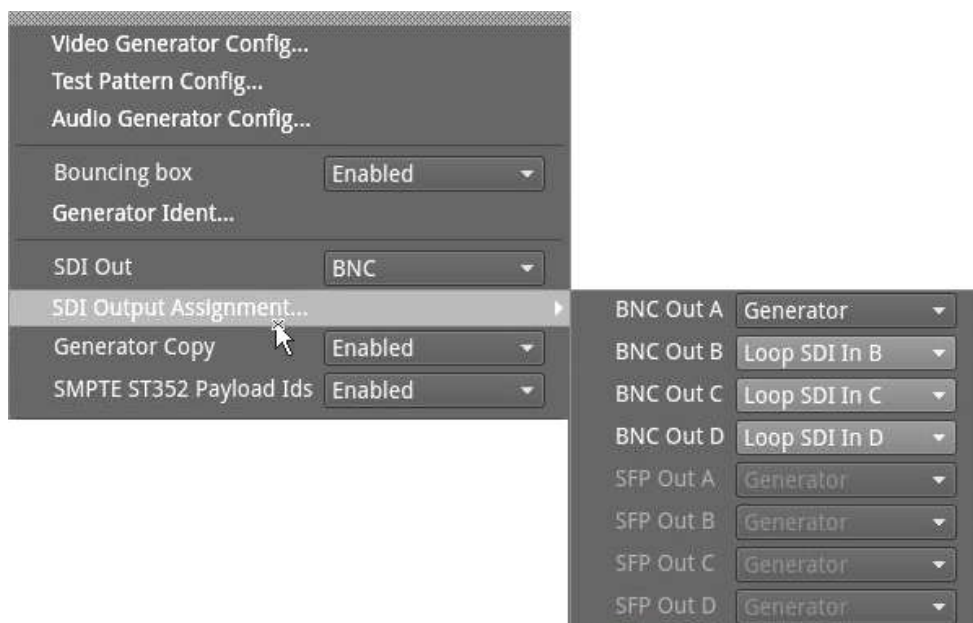

Figure 6-17: Generator - SDI Output Assignment

The following table lists the configurable SDI Output parameters for the Generator instrument:

Table 6-6 : Generator - SDI Output Menu Options

Item	Options	Description
Generator SDI Output Options		
SDI Out	BNC (Default) SFP	Select the Output SDI connector type you require.
BNC Out A BNC Out B BNC Out C	Off Generator (Default) Loop SDI In A (SD-SDI)	Choose whether to configure each SDI BNC Out connector (A, B, C or D) individually, to use either the Loop SDI In A (B, C, or D) signal, the Generator signal or to switch off the output.

Item	Options	Description
BNC Out D	Loop SDI In A (B, C, or D) (HD-SDI)	
SFP Out A SFP Out B SFP Out C SFP Out D	Off Generator (Default)	Choose whether to configure each SDI SFP Out channel (A, B, C or D) individually, to use the Generator signal or to switch off the output. Note that the number of Generator Copies that you can have on an SFP depends on the number and type of SFPs that are fitted and the link format.

For information on configuring the Generator SDI Out and Copy signals, see the section [System IO for SDI Modes \(Factory Fitted Option\)](#).

Insertion of ST352 Video Payload IDs (ST 2022-6 and SDI Modes)

The unit includes SMPTE ST352 Payload IDs in the generated standards by default. You can view the Hex IDs in Line 10 of the **Analyzer - Dataview** instrument. Alternatively select the Identifier **ST352 Payload ID** in the options menu of the **Analyzer - Ancillary Inspector** instrument.

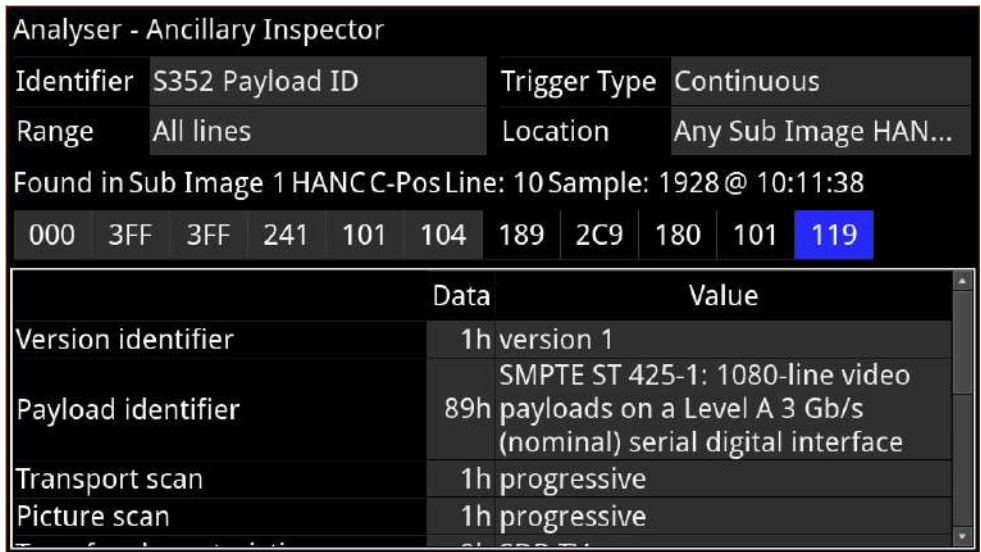

Figure 6-18: Analyzer - Ancillary Inspector Showing SMPTE ST352 Payload IDs

If you need to disable this feature (for example, for test purposes) you can do so by setting the parameter **SMPTE ST352 Payload Ids** in the Generator options menu to **Disabled**. When you select this option, the Generator displays the selected video standard in yellow font and appends the text:

ST 352 DISABLED.

For example:



After re-enabling Payload IDs, always regenerate the standard to ensure that the Payload IDs are included.

Pathological Signal Insertion

Pathological Signal Insertion is a powerful feature used to test signal performance.

In addition to selecting a background test pattern, you can insert a pathological pattern as an overlay to the original test pattern. Enable pathological signal insertion from the Pathological Insertion submenu of the **Generator** options menu:

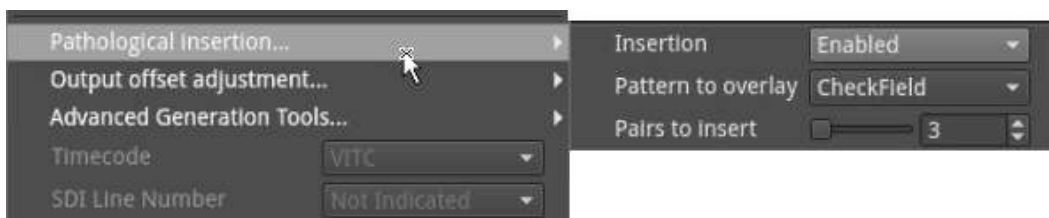

Figure 6-19: Generator - Pathological Signal Insertion Options

Table 6-7 : Generator - Pathological Signal Insertion Menu Options

Item	Options	Description
Pathological Insertion Options		
Insertion	Enabled Disabled (Default)	Enable or disable pathological signal insertion.
Pattern to overlay	Eq PLL Clock (CLK), CheckField (Eq + PLL) CheckField + Clock (Eq + PLL + CLK)	Select the pathological patterns to insert from the displayed options.
Pairs to insert	System Control Range: 0 to 16384	Set the amount of pathological pattern to verify the sensitivity of the SDI link to pathological conditions on the interface. This control limits at the line length of the selected format.

Note: Pathological signals are approved by SMPTE for use with HD and 3G Level A standards only. For 3G Level B, 6G and 12G-SDI interface formats, pathological signals can be used, but are not approved by SMPTE (as of January 2020). It is believed that inserting a full line of pathological signal in these non-approved standards is too stressful a test for the SDI interface. No physical damage will occur, but the interface may exhibit reduced operating performance in the form of bit errors.

Output Offset Adjustment (Optional SDI Output)

You can configure the Generator to generate a signal with a fixed offset, relative to the system reference using the **Output offset adjustment...** submenu available from the **Generator** options menu.



Figure 6-20: Generator - Output Offset Adjustment Submenu

The following table lists the output offset adjustment options available:

Table 6-8 : Generator - Output Offset Adjustment Menu Options

Item	Options	Description
Output Offset Adjustment Options		
Offset Type	Lines And Pixels (Default) Time	Select whether to make offset adjustments using either spatial or temporal values.
Output Line Offset	0 to +/- (Total number of Lines for current standard minus one)	When set to Lines and Pixels, use the combo-box to set the Line offset component as a number of whole lines.
Output Pixel Offset	0 to +/- (Total number of Pixels per Line for current standard minus one)	When set to Lines and Pixels, use the combo-box to set the Pixel offset component as a number of pixels per line.
Output Time Offset	0.00, +/- 0.01, etc...	When set to Time, use the combo-box to set the timing off-

Item	Options	Description
		set in microseconds.
Clear Offsets	System Control	Select to remove the current Generator offset.

Generator (Audio) (ST 2022-6 IP & Optional SDI Output)



Requires Option(s):	PHQXLO-GEN
---------------------	------------

Overview

You can configure the generation of up to 32-channels of audio in the **Audio Generator Config...** dialog of the **Generator** options menu.

Right-click in the Generator instrument to open the options menu. Select **Audio Generator Config...** to display the audio configuration dialog.

Using the Audio Generator Configuration dialog you can:

- Generate a fixed audio frequency (in Herz or musical pitch) for **all** audio channels
- Generate a ramped audio frequency (in Herz or musical pitch), in decreasing steps of 50 Hz (0.05 kHz), for **all** audio channels
- Generate a fixed audio amplitude (in dBFS) for **all** audio channels
- Generate a ramped audio amplitude (in dBFS), in increasing steps of 1 dBFS, for **all** audio channels
- Generate a custom frequency (in Herz or musical pitch) for either both channels, the left channel only, or right channel only of the **selected channel pair**
- Generate a custom amplitude for either both channels, the left channel only, or right channel only of the **selected channel pair**.

The audio generator configuration dialog is roughly subdivided into three functional areas as shown in [Figure 6-21](#). To configure an audio output signal, first select the required audio options in the left-side options panel then select the target groups, channel pairs or single channel using the toggle switch or target channel selector as appropriate. Finally, adjust the frequency and / or amplitude sliders to set the audio output signal as required.

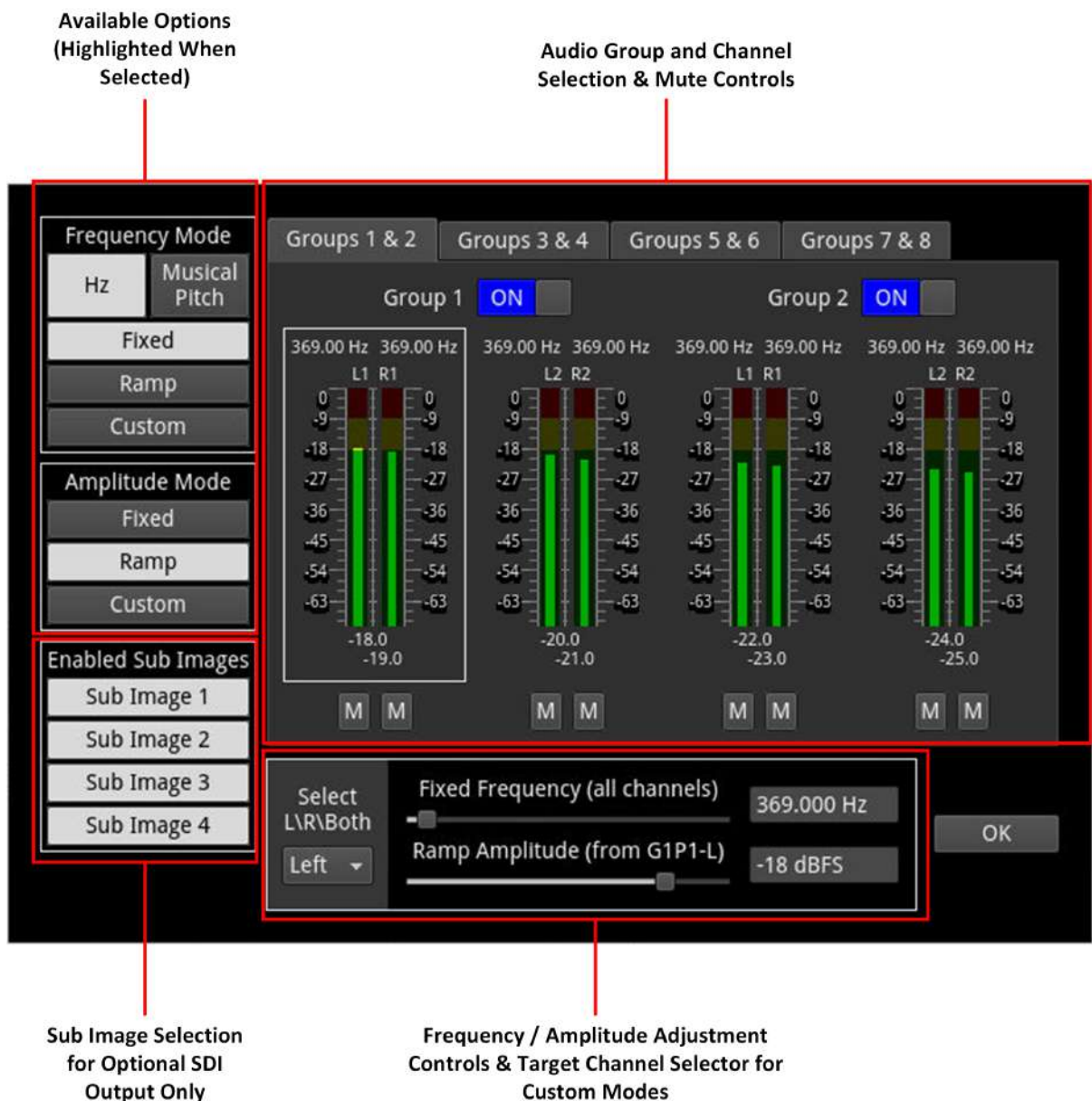

Figure 6-21: Generator Configuration - Audio Tab (ST 2022-6 IP and Optional SDI Output)

Depending on the generated video standard, up to eight audio groups (32 channels) are available. In the Audio Generator Configuration dialog, for ST 2022-6 IP or optional SDI output, you can switch audio groups on or off as required using the **Group n** activation toggle switches. Use the Audio Group tabs to display additional groups.

The options side panel (below) enables you to select the desired frequency and / or amplitude modes and in addition, enable or disable the video sub-image to include the audio signal.

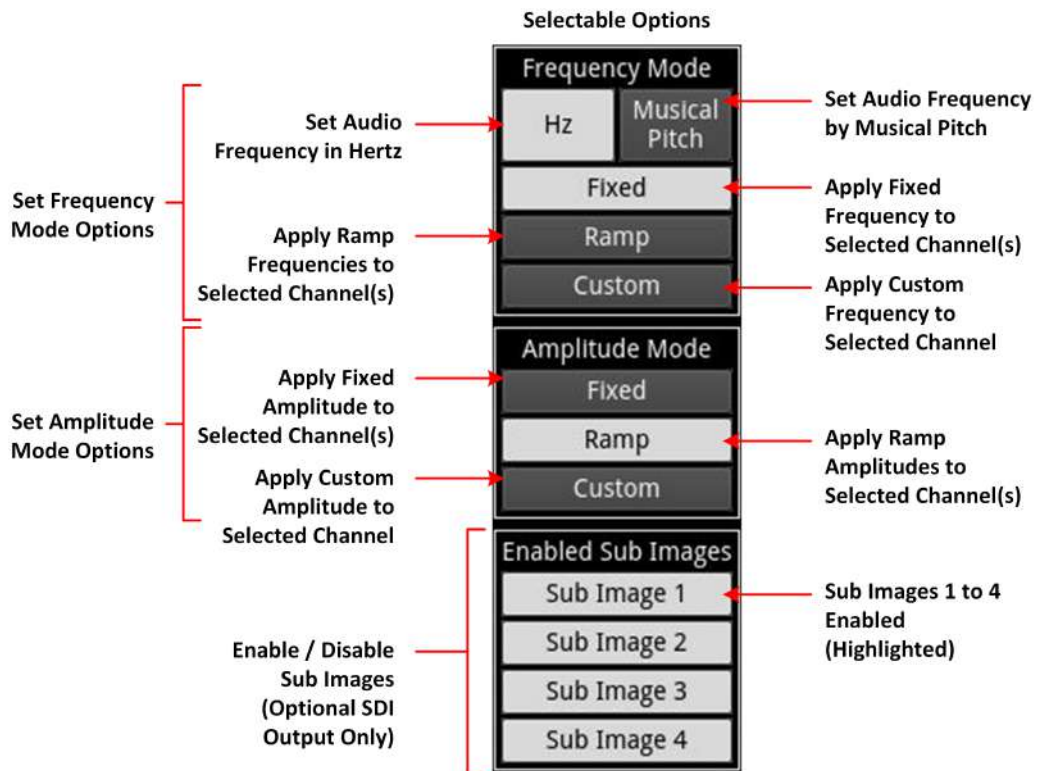

Figure 6-22: Audio Generator Configuration Dialog - Options Panel

After selecting the desired audio options in the side panel, use the audio group and channel selection controls ([Figure 6-23](#)) to activate or deactivate the target audio groups or channels for the output of the generated audio signal. You can click to select a pair of channels within a group of four channels as the target for a custom frequency or amplitude setting. A selected pair is shown with a white border.

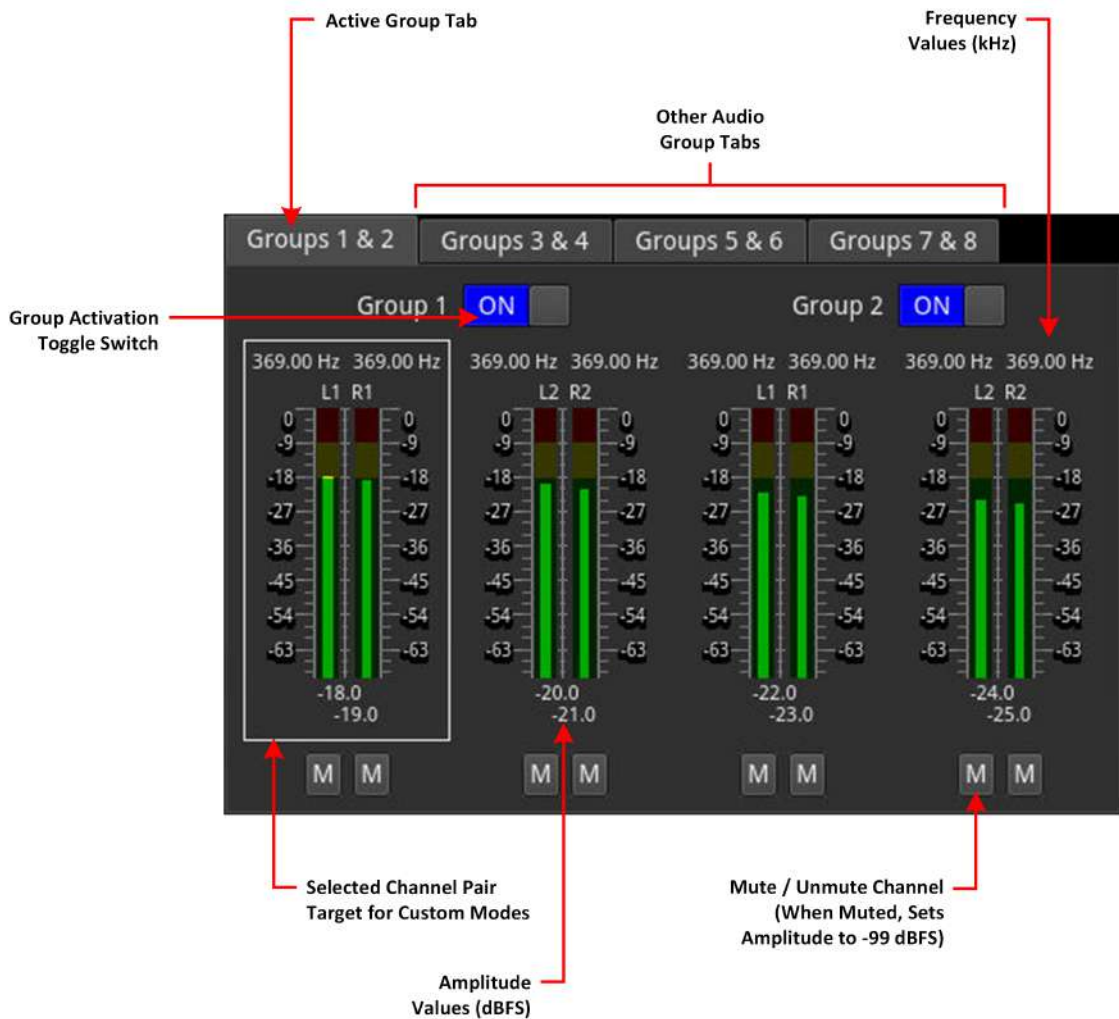

Figure 6-23: Audio Generator Configuration Dialog - Audio Group Selection Panel

You can also use this panel to mute or unmute any of the individual meters.

When setting either a fixed or ramp frequency and / or amplitude for all channels, slide the appropriate control(s) in the adjustment controls panel ([Figure 6-24](#)) to the left or right as required.

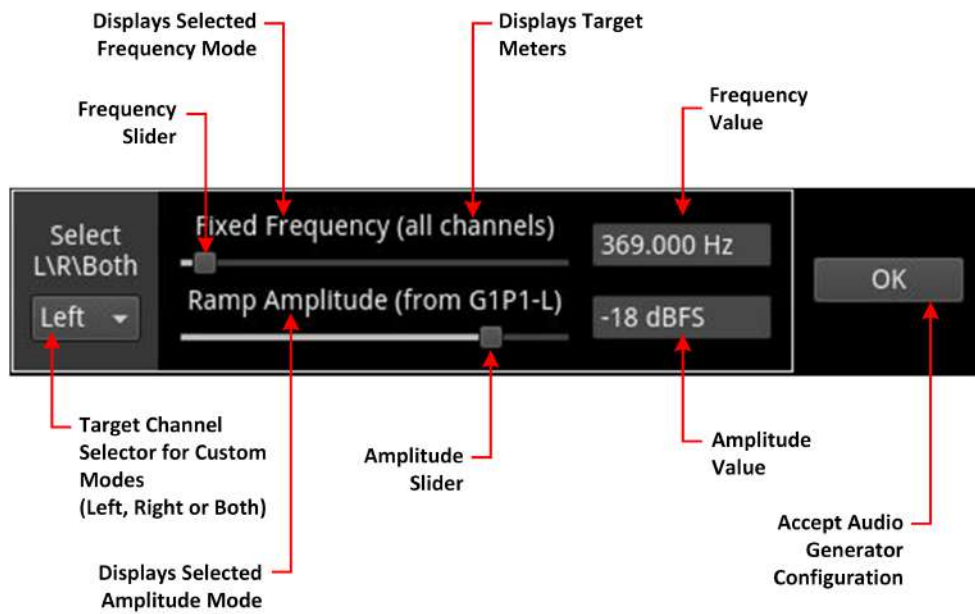

Figure 6-24: Audio Generator Configuration Dialog - Adjustment Controls

When configuring a custom setting for either frequency, and / or amplitude, use the target channel selector to define the channels or individual channels to which the custom setting applies. This could be either both channels of the selected pair, the left channel, or the right channel. You will see the target meter(s) displayed in the label above the appropriate slider control.

Audio Generator Configuration Dialog

Using the Audio Configuration dialog, you can configure each channel by frequency and amplitude. In addition, you can set the Frequency by musical pitch, fixed tone or by specifying a custom tone frequency (Hz):

Table 6-9 : Audio Generator Parameters (ST 2022-6 IP or Optional SDI Output)

Audio Generator Column	Available Filter Parameters																																																				
Channel	Group 1 to 8; then for each Group: <ul style="list-style-type: none"> • Pair 1 Left • Pair 1 Right • Pair 2 Left • Pair 2 Right 																																																				
Type and Frequency	<p>Tone Select Frequency from: 0 to 10,000 Hz (10 kHz)</p> <hr/> <p>Music Pitch Select Frequency from:</p> <table style="width: 100%; border-collapse: collapse;"> <tr> <td>C 3,</td> <td>C#/D\flat 3,</td> <td>D 3,</td> <td>D#/E\flat 3,</td> </tr> <tr> <td>E 3,</td> <td>F 3,</td> <td>F#/G\flat 3,</td> <td>G 3,</td> </tr> <tr> <td>G#/A\flat 3,</td> <td>A 3,</td> <td>A#/B\flat 3,</td> <td>B 3,</td> </tr> <tr> <td>C 4,</td> <td>C#/D\flat 4,</td> <td>D 4,</td> <td>D#/E\flat 4,</td> </tr> <tr> <td>E 4,</td> <td>F 4,</td> <td>F#/G\flat 4,</td> <td>G 4,</td> </tr> <tr> <td>G#/A\flat 4,</td> <td>A 4,</td> <td>A#/B\flat 4,</td> <td>B 4,</td> </tr> <tr> <td>C 5,</td> <td>C#/D\flat 5,</td> <td>D 5,</td> <td>D#/E\flat 5,</td> </tr> <tr> <td>E 5,</td> <td>F 5,</td> <td>F#/G\flat 5,</td> <td>G 5,</td> </tr> <tr> <td>G#/A\flat 5,</td> <td>A 5,</td> <td>A#/B\flat 5,</td> <td>B 5,</td> </tr> <tr> <td>C 6,</td> <td>C#/D\flat 6,</td> <td>D 6,</td> <td>D#/E\flat 6,</td> </tr> <tr> <td>E 6,</td> <td>F 6,</td> <td>F#/G\flat 6,</td> <td>G 6,</td> </tr> <tr> <td>G#/A\flat 6,</td> <td>A 6,</td> <td>A#/B\flat 6,</td> <td>B 6,</td> </tr> <tr> <td>C 7</td> <td></td> <td></td> <td></td> </tr> </table>	C 3,	C#/D \flat 3,	D 3,	D#/E \flat 3,	E 3,	F 3,	F#/G \flat 3,	G 3,	G#/A \flat 3,	A 3,	A#/B \flat 3,	B 3,	C 4,	C#/D \flat 4,	D 4,	D#/E \flat 4,	E 4,	F 4,	F#/G \flat 4,	G 4,	G#/A \flat 4,	A 4,	A#/B \flat 4,	B 4,	C 5,	C#/D \flat 5,	D 5,	D#/E \flat 5,	E 5,	F 5,	F#/G \flat 5,	G 5,	G#/A \flat 5,	A 5,	A#/B \flat 5,	B 5,	C 6,	C#/D \flat 6,	D 6,	D#/E \flat 6,	E 6,	F 6,	F#/G \flat 6,	G 6,	G#/A \flat 6,	A 6,	A#/B \flat 6,	B 6,	C 7			
C 3,	C#/D \flat 3,	D 3,	D#/E \flat 3,																																																		
E 3,	F 3,	F#/G \flat 3,	G 3,																																																		
G#/A \flat 3,	A 3,	A#/B \flat 3,	B 3,																																																		
C 4,	C#/D \flat 4,	D 4,	D#/E \flat 4,																																																		
E 4,	F 4,	F#/G \flat 4,	G 4,																																																		
G#/A \flat 4,	A 4,	A#/B \flat 4,	B 4,																																																		
C 5,	C#/D \flat 5,	D 5,	D#/E \flat 5,																																																		
E 5,	F 5,	F#/G \flat 5,	G 5,																																																		
G#/A \flat 5,	A 5,	A#/B \flat 5,	B 5,																																																		
C 6,	C#/D \flat 6,	D 6,	D#/E \flat 6,																																																		
E 6,	F 6,	F#/G \flat 6,	G 6,																																																		
G#/A \flat 6,	A 6,	A#/B \flat 6,	B 6,																																																		
C 7																																																					
Amplitude	Adjust amplitude levels in decibels relative to full scale (dBFS), select: -99 to 0 dBFS																																																				

Generator (Audio) (ST 2110 IP Output)



Requires Option(s):	PHQXLO-GEN
---------------------	------------

You can configure the generation of audio signals for ST 2110 IP output using the **Audio Generator Config...** dialog from the **Generator** options menu. The Audio Generator Configuration dialog provides Level C audio operation with:

- Up to 80 channels at 125 μ s and ten channels at 1 ms packet time (ST 2110-30) or
- Up to 60 channels at 125 μ s and seven channels at 1 ms packet time (ST 2110-31).

Right-click in the Generator instrument to open the options menu, then select **Audio Generator Config...** to display the audio configuration dialog.

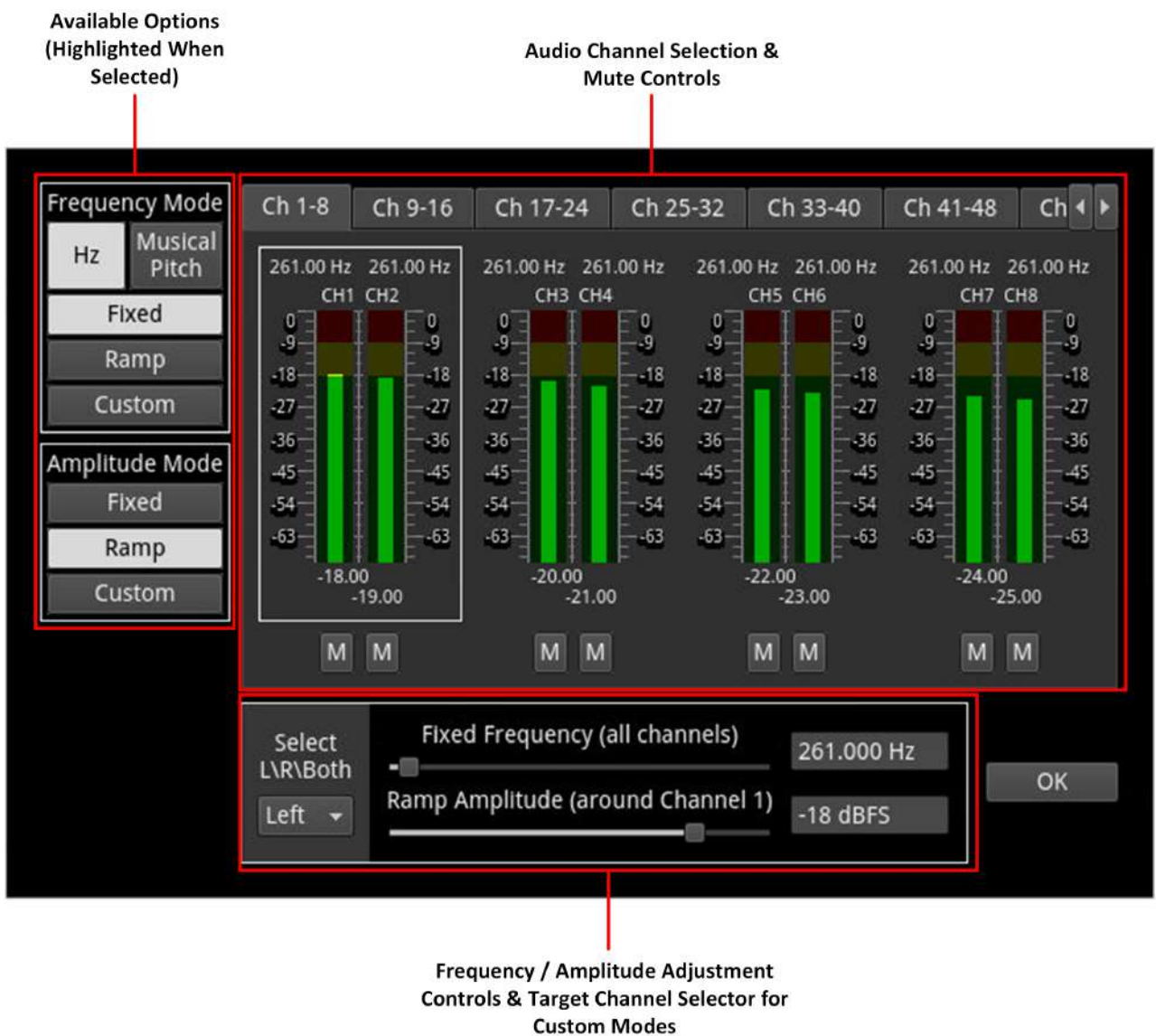

Figure 6-25: Audio Generator Configuration Dialog (ST 2110 IP Output)

Using the Audio Generator Configuration dialog you can:

- Generate a fixed audio frequency (in Herz or musical pitch) for **all** audio channels
- Generate a ramped audio frequency (in Herz or musical pitch), in decreasing steps of 50 Hz (0.05 kHz), for **all** audio channels
- Generate a fixed audio amplitude (in dBFS) for **all** audio channels
- Generate a ramped audio amplitude (in dBFS), in increasing steps of 1 dBFS, for **all** audio channels
- Generate a custom frequency (in Herz or musical pitch) for either both channels, the left channel only, or right channel only of the **selected channel pair**
- Generate a custom amplitude for either both channels, the left channel only, or right channel only of the **selected channel pair**.

The audio generator configuration dialog is roughly subdivided into three functional areas as shown in [Figure 6-25](#). To configure an audio output signal, first select the required audio options in the left-side options panel then select the target channel pairs or single channel using the target channel selector as appropriate. Use the tabs and arrow keys to display additional channels. Finally, adjust the frequency and / or amplitude sliders to set the audio output signal as required.

The options side panel (below) enables you to select the desired frequency and / or amplitude modes and in addition, enable or disable the video sub-image to include the audio signal.

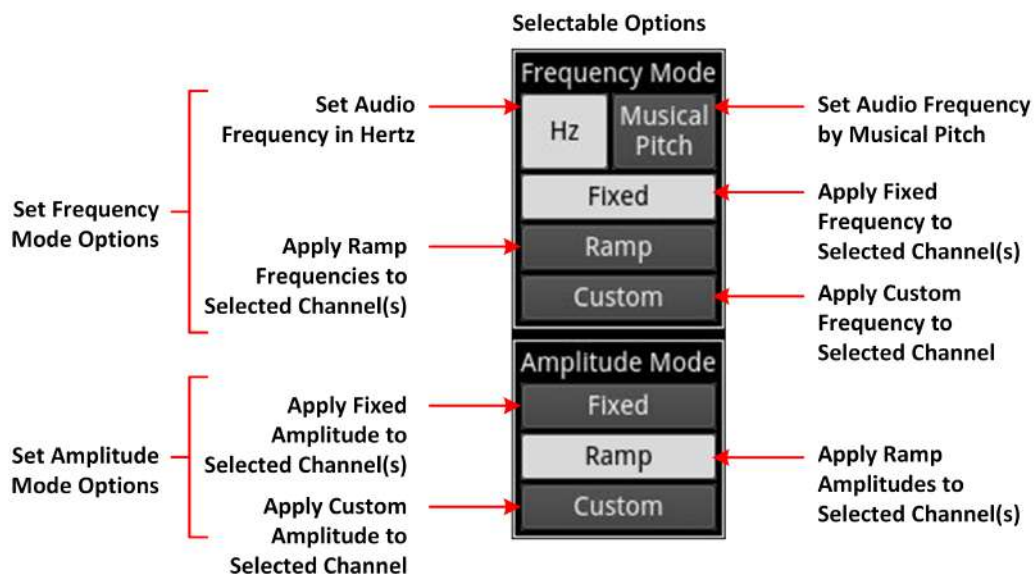

Figure 6-26: Audio Generator Configuration Dialog - Options Panel

After selecting the desired audio options in the side panel, use the audio group and channel selection controls ([Figure 6-27](#)) to activate or deactivate the target audio groups or channels for the output of the generated audio signal. You can click to select a pair of channels within a group of four channels as the target for a custom frequency or amplitude setting. A selected pair is shown with a white border.

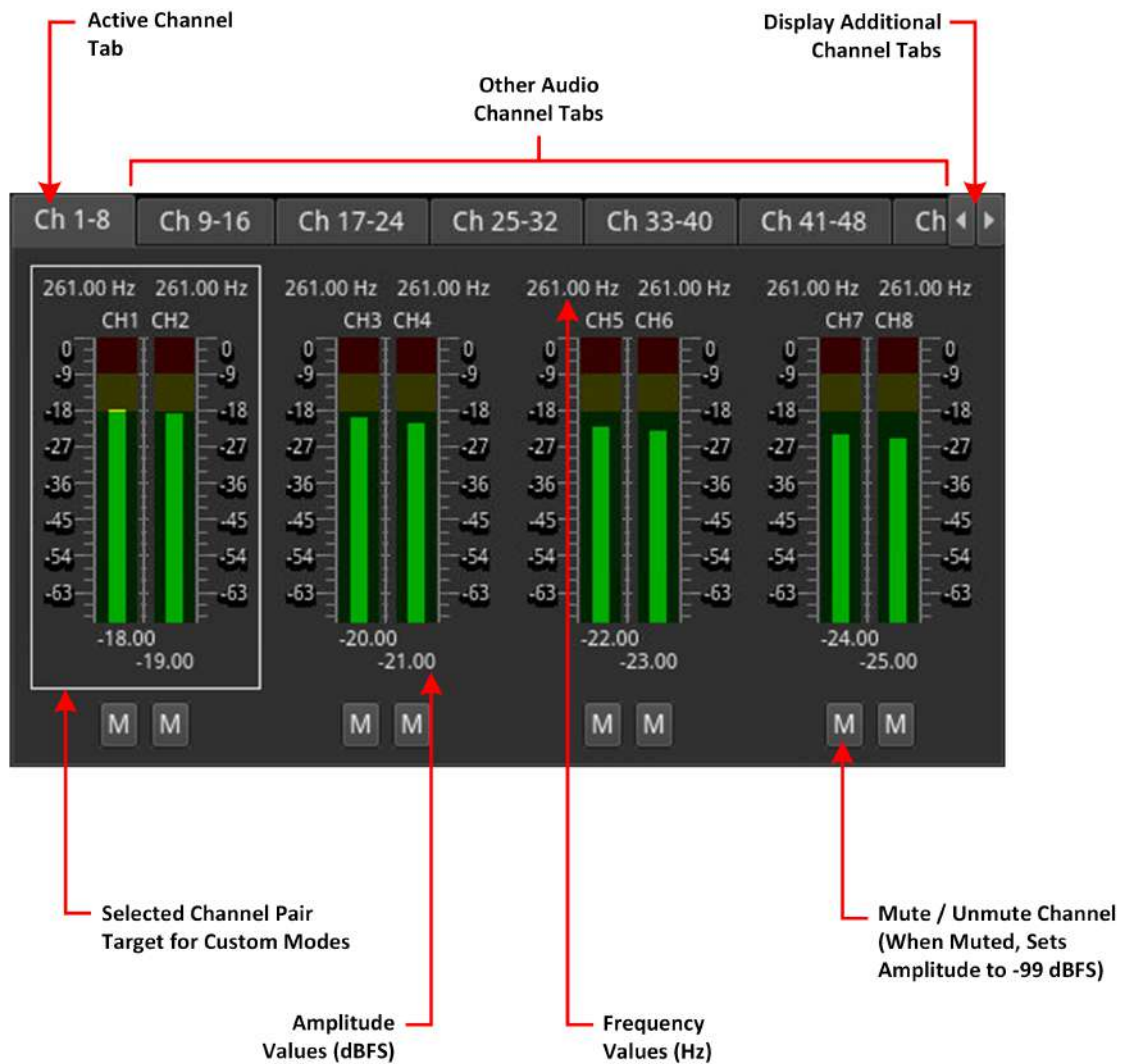

Figure 6-27: Audio Generator Configuration Dialog - Audio Channel Selection Panel

You can also use this panel to mute or unmute any of the individual meters.

When setting either a fixed or ramp frequency and / or amplitude for all channels, slide the appropriate control(s) in the adjustment controls panel ([Figure 6-28](#)) to the left or right as required.

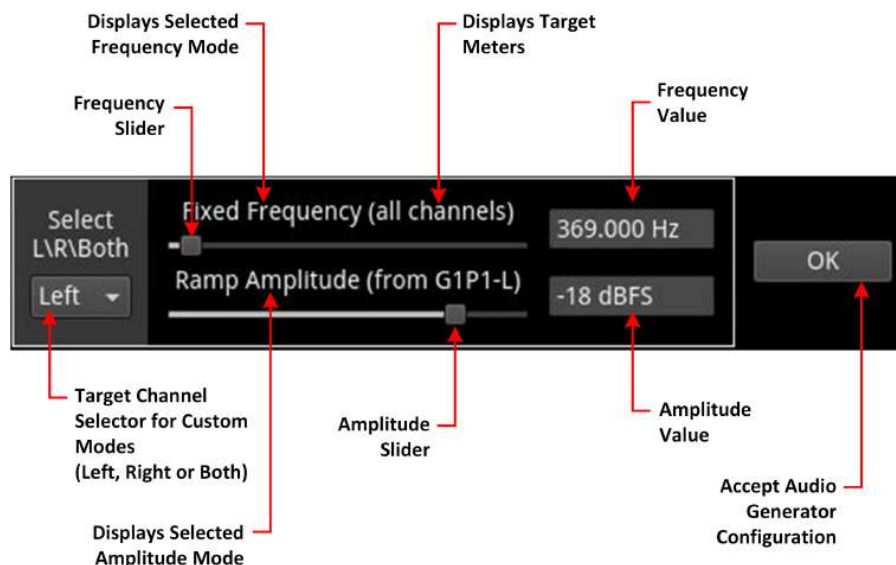

Figure 6-28: Audio Generator Configuration Dialog - Adjustment Controls

When configuring a custom setting for either frequency, and / or amplitude, use the target channel selector to define the channels or individual channels to which the custom setting applies. This could be either both channels of the selected pair, the left channel, or the right channel. You will see the target meter(s) displayed in the label above the appropriate slider control.

Audio Generator Configuration Dialog

Using the configuration dropdown menus, you can configure each channel by frequency and amplitude. In addition, you can set the Frequency by music pitch or by specifying the exact tone frequency (Hz):

Table 6-10 : Audio Generator Parameters (ST 2110 IP Output)

Audio Feature	Available Parameters																																																				
Channel	<ul style="list-style-type: none"> • Ch 1 - 8 • Ch 9 - 16 • Ch 17 - 24 • Ch 25 - 32 • Ch 33 - 40 • Ch 41 - 48 • Ch 49 - 56 • Ch 57 - 64 • Ch 65 - 72 • Ch 73 - 80 																																																				
Type and Frequency	<p>Tone Select Frequency from: 0 to 10000 Hz</p> <hr/> <p>Music Pitch Select Frequency from:</p> <table style="width: 100%; border-collapse: collapse;"> <tr> <td style="width: 25%;">C 3,</td> <td style="width: 25%;">C#/D\flat 3,</td> <td style="width: 25%;">D 3,</td> <td style="width: 25%;">D#/E\flat 3,</td> </tr> <tr> <td>E 3,</td> <td>F 3,</td> <td>F#/G\flat 3,</td> <td>G 3,</td> </tr> <tr> <td>G#/A\flat 3,</td> <td>A 3,</td> <td>A#/B\flat 3,</td> <td>B 3,</td> </tr> <tr> <td>C 4,</td> <td>C#/D\flat 4,</td> <td>D 4,</td> <td>D#/E\flat 4,</td> </tr> <tr> <td>E 4,</td> <td>F 4,</td> <td>F#/G\flat 4,</td> <td>G 4,</td> </tr> <tr> <td>G#/A\flat 4,</td> <td>A 4,</td> <td>A#/B\flat 4,</td> <td>B 4,</td> </tr> <tr> <td>C 5,</td> <td>C#/D\flat 5,</td> <td>D 5,</td> <td>D#/E\flat 5,</td> </tr> <tr> <td>E 5,</td> <td>F 5,</td> <td>F#/G\flat 5,</td> <td>G 5,</td> </tr> <tr> <td>G#/A\flat 5,</td> <td>A 5,</td> <td>A#/B\flat 5,</td> <td>B 5,</td> </tr> <tr> <td>C 6,</td> <td>C#/D\flat 6,</td> <td>D 6,</td> <td>D#/E\flat 6,</td> </tr> <tr> <td>E 6,</td> <td>F 6,</td> <td>F#/G\flat 6,</td> <td>G 6,</td> </tr> <tr> <td>G#/A\flat 6,</td> <td>A 6,</td> <td>A#/B\flat 6,</td> <td>B 6,</td> </tr> <tr> <td>C 7</td> <td></td> <td></td> <td></td> </tr> </table>	C 3,	C#/D \flat 3,	D 3,	D#/E \flat 3,	E 3,	F 3,	F#/G \flat 3,	G 3,	G#/A \flat 3,	A 3,	A#/B \flat 3,	B 3,	C 4,	C#/D \flat 4,	D 4,	D#/E \flat 4,	E 4,	F 4,	F#/G \flat 4,	G 4,	G#/A \flat 4,	A 4,	A#/B \flat 4,	B 4,	C 5,	C#/D \flat 5,	D 5,	D#/E \flat 5,	E 5,	F 5,	F#/G \flat 5,	G 5,	G#/A \flat 5,	A 5,	A#/B \flat 5,	B 5,	C 6,	C#/D \flat 6,	D 6,	D#/E \flat 6,	E 6,	F 6,	F#/G \flat 6,	G 6,	G#/A \flat 6,	A 6,	A#/B \flat 6,	B 6,	C 7			
C 3,	C#/D \flat 3,	D 3,	D#/E \flat 3,																																																		
E 3,	F 3,	F#/G \flat 3,	G 3,																																																		
G#/A \flat 3,	A 3,	A#/B \flat 3,	B 3,																																																		
C 4,	C#/D \flat 4,	D 4,	D#/E \flat 4,																																																		
E 4,	F 4,	F#/G \flat 4,	G 4,																																																		
G#/A \flat 4,	A 4,	A#/B \flat 4,	B 4,																																																		
C 5,	C#/D \flat 5,	D 5,	D#/E \flat 5,																																																		
E 5,	F 5,	F#/G \flat 5,	G 5,																																																		
G#/A \flat 5,	A 5,	A#/B \flat 5,	B 5,																																																		
C 6,	C#/D \flat 6,	D 6,	D#/E \flat 6,																																																		
E 6,	F 6,	F#/G \flat 6,	G 6,																																																		
G#/A \flat 6,	A 6,	A#/B \flat 6,	B 6,																																																		
C 7																																																					
Amplitude	Adjust amplitude levels in decibels relative to full scale (dBFS), select: -99 to 0 dBFS																																																				

2022-6 Transmit (SFP F) (ST 2022-6 IP Output)



Requires Option(s):	PHQXLO-GEN and PHQXLO-IP-NGT
---------------------	------------------------------

Overview

The **2022-6 Transmit (SFP F)** window is used to transmit the currently generated video standard signal as ST 2022-6 standard video packets.

You can use this instrument to simulate IP video network packet jitter introduced under a variety of network conditions by adjusting the transmission distribution profile.

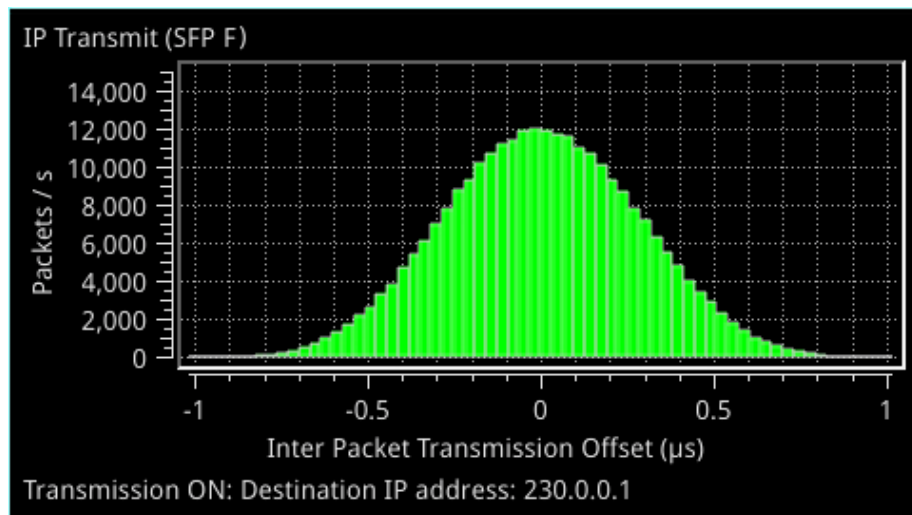

Figure 6-29: 2022-6 Transmit (SFP F)

The histogram shows the interval timing distribution of the packets being generated (each second) - that is: the number of packets being generated each second, against the deviation of each packet interval from the expected interval time. Transmission status information and prompts are also displayed at the bottom of the window. Hover over this status information to display a tooltip detailing the Current Transmit Parameters, see the section [Network Settings](#) for more information.

Instrument Menu Options

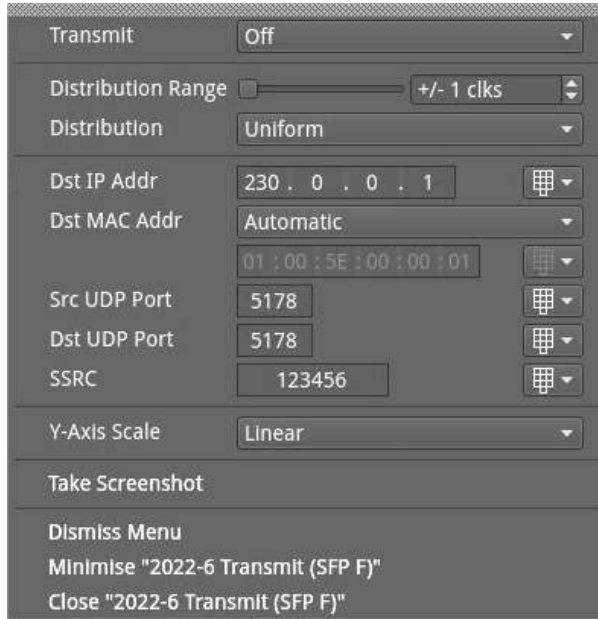

Figure 6-30: 2022-6 Transmit (SFP F) Menu Options

Network Settings

IP, UDP, MAC, and SSRC network settings for packet transmission are set in the submenu, and can be entered using the numeric keypad or a connected USB keyboard when **Transmit** is set to **Off**.

Transmission can be either multicast or unicast. The multicast group destination IP address, or the IP address of the receive device (in the case of unicast) should be set as the destination IP address, as required.

The following table lists the configurable parameters in the 2022-6 Transmit (SFP F) options menu:

Table 6-11 : 2022-6 Transmit (SFP F) Menu Options

Item	Options	Description
Transmit	On Off (Default)	Switch packet transmission for IP 2022-6 output on or off.
Distribution Range	System Control (Slider) +/- 0 (default) to 492 clks for a 1.5G signal or +/- 0 (default) to 204 clks for a 3G signal	Adjust the range of transmission packet intervals. The adjustments are displayed in real-time, in the transmission histogram.
Distribution	Uniform (Default) Gaussian	Select the type of distribution profile plotted in the transmission histogram.
Dst IP Addr	Numeric Entry	Destination IP address for the Tx flow; may be multicast or unicast. The destination MAC address (see below) should be set as required, to Automatic for multicast, or SFP E for unicast transmission to the same unit (using ST 2022-6 IP output to transmit from SFP F and ST 2022-6 input to receive on SFP E). For unicast transmission to another device, set to Manual , and then enter the MAC address of the receive device (in

Item	Options	Description
		<p>the case of a direct connection) or the first switching device in the path of the transmitting unit (for an indirect connection to the receive device).</p> <p>Changes to addressing parameters are applied when you switch the Transmit option On.</p>
Dst MAC Addr	Automatic (Default) Manual SFP E	<p>When set to Automatic, if the IP address is a multicast address the Destination MAC address is automatically calculated from the IP address.</p> <p>If the IP address is a unicast address, the unit uses ARP (Address Resolution Protocol) for that IP address and automatically learns the MAC address.</p> <p>If the MAC address cannot be found then the flow is not enabled and the unit displays a warning message.</p>
Src UDP Port	Numeric Entry	Set the source UDP port number as required.
Dst UDP Port	Numeric Entry	Set the destination UDP port number as required.
SSRC	Numeric Entry	Set a Synchronization source identifier (SSRC) for Real-time Transport Protocol (RTP) stream subscription, if required.
Y-Axis Scale	Linear (Default) Log10	Plot the number of transmitted packets on the vertical axis using either a linear or logarithmic scale.

Once you have entered all required network settings, switch Transmit **On** to start transmission.

Note: Ensure that you are generating a test signal for transmission in the **Generator** Instrument.

2110 Transmit (ST 2110 IP Output)



Requires Option(s):	PHQXLO-GEN
---------------------	------------

Overview

The **2110 Transmit** Instrument enables you to transmit two different types of flow from the unit: either **Generator Flows** or **Monitor Flows**. The **Generator Flows** are the video test patterns from the Video Generator and the audio tones are from the Audio Generator. The **Monitor Flows** are the video and audio signals for the HDMI and SDI monitor outputs or audio being monitored by the Analyzer - Audio Meters instrument, i.e., the screen display and any audio feed to the unit's monitor.

You can configure the currently generated Generator flows and the Monitor flows as IP video flows (2110-20), audio flows (2110-30/-31) or ancillary (ANC) flows (2110-40) for transmission from either SFP E, SFP F or SFPs E+F (2022-7 Seamless Protection Switching mode). The 2110 Transmit instrument supports a full range of PHABRIX test patterns, including: Bars, SMPTE/ARIB Bars, Test Card (Circle), Ramps, Color Grid, Steps PLUGE at all supported frame rates and in SDR or HDR Formats.

The main 2110 Transmit instrument window displays a series of tabs providing access to IP transmission status information for the Generator and Monitor flows as follows:

- **Tx:** Displays a summary of the current status of all selected generator / monitor video, audio and ancillary flows being transmitted.
- **VID:** Displays the current status of the video flow from the Video Generator.
- **AUD1-2:** Displays the current status of the audio flows AUD1 and AUD2 from the Audio Generator.
- **AUD3-4:** Displays the current status of the audio flows AUD3 and AUD4 from the Audio Generator.
- **ANC:** Displays the current status of the ancillary (ANC) flow from the Video Generator.
- **MON:** Displays the current status of the monitor video and audio flows.

You can configure all Generator and Monitor flows to be transmitted by either SFP E, SFP F, or dual-mirrored flows from SFPs E and F. The dual-mirrored flows on SFP E and SFP F are a co-timed, SMPTE ST 2022-7 pair which allows an ST 2022-7 receiver to reconstruct a non-errored flow seamlessly if one of the source flows contains errors. Both Generator and Monitor flows can be transmitted simultaneously providing a maximum of two video flows, five audio flows and one ANC flow from each interface.

Right-click in any of the 2110 Transmit status tabs to display the options menu.

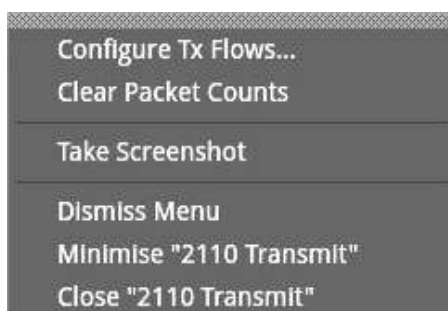

Figure 6-31: 2110 Transmit Options Menu

Table 6-12 : 2110 Transmit Menu Options

Item	Options	Description
Configure Tx Flows...	Instrument Control	Opens the Transmit configuration dialog to select and configure the flows for transmission from the unit.
Clear Packet Counts	Instrument Control	Reset the cumulative packet counts, displayed in the Packets column of the Tx Summary tab, to zero.

Transmitting Generator Video and Audio Flows

The **Generator Video** flows transmit a test pattern from the Video Generator as a 2110-20 flow. The video flow supports the following parameters:

- **Resolution:** 1280x720, 1920 x 1080, 2048x1080. In addition, when connected to a 25G network: 3840x2160, 4096x2160.
- **Color Mapping:** YCbCr:422:10
- **Frame Rates:** 23.98p, 24p, 25p, 29.97p, 30p, 47.95p, 48p, 50p, 59.94p, 60p, 50i, 59.94i, 60i
- **Color Space:** SDR-709, SDR-2020, HDR-HLG, HDR-PQ, HDR-Slog3

The Generator Video flow can be Gapped or Linear, with Packing Mode using either GPM (in single- or multi-line mode) or BPM.

The **Generator Audio** flows transmit generated PCM audio tones as four 2110-30 / -31 flows. Audio can be configured from the Audio Generator. In the 2110 Transmit instrument, you can configure the Generator Audio flows with Packet Times of 1 ms or 125 μ s.

Transmitting the Generator test pattern as a flow provides the following features:

- Video: ST 2110-20 / 2022-7 video flow pair comprising of any 1920 x 1080 Progressive or Interlaced YCbCr 422 10-bit Test Pattern with optional Bouncing Box.
- Choice of Narrow Gapped or Narrow Linear Packet Read Schedule (PRS)
- General Packing Mode (GPM) (single- or multi-line mode) or Block Packing Mode (BPM)
- Full range of PHABRIX Patterns (Bars, SMPTE/ARIB Bars, Test Card (Circle), Ramps, Color Grid, Steps PLUGE)
- Full range of Formats: SDR(709), SDR(2020), HDR: PQ, HLG, Slog-3, SR-Live(2020)
- Full range of Progressive Frame Rates: 23.98, 24, 25, 29.97, 30, 47.95, 48, 50, 59.94, 60 Hz.
- Interlaced Frame Rates: 50, 59.94, 60 Hz
- Phase Control of $T_{R_{Offset}}$ with respect to PTP T_{Frame}
- Generator Audio: Transmits up to four accompanying 48 kHz sampling 24-bit Test Tone/Musical Pitch 2022-7 Audio flow pairs with independent selection of ST 2110-30 or 2110-31 and 1 ms or 125 μ s Packet Time for each flow pair.
- Level C Audio Operation with up to 80 channels at 125 μ s and ten channels at 1 ms packet time (ST 2110-30); up to 60 channels at 125 μ s and seven channels at 1 ms packet time (ST 2110-31).
- Audio Generator Macros including Fixed Tone, Fixed Tone Ramp, Musical Pitch Fixed, Musical Pitch Ramp with independent control of Tone/Pitch and Amplitude for each Channel.

Transmitting Monitor Video and Audio Flows

The **Monitor Video** flows transmit the graphical user interface as a 2110-20 video flow so the video displays the same picture as is output by way of the HDMI port and has a resolution of 1920 x 1080 progressive YCbCr:422:10bit. The frame rate is set to the same as the HDMI and SDI monitor out and is set from the control in the launch menu **Display** settings. The frame rate options are 60 Hz, 59.94 Hz, 50 Hz, with the flow fixed to Gapped and BPM.

The **Monitor Audio** flow transmits the monitored audio pair from the [Audio Meters](#) instrument as a two channel, 2110-30 / -31 flow with either 1 ms or 125 µs packet time. This is the same audio as is output from the HDMI or SDI monitor out. The audio signal comprising this flow is controlled by selecting the Monitor or Solo buttons in the Audio Meters instrument.

Transmitting the Monitor output as a flow provides the following features:

- Video: ST 2110-20 / 2022-7 video flow pair carrying the Instrument Graphical User interface (GUI, HDMI screen) at 1920x1080 at 50, 59.94, or 60 Hz Progressive Frame Rates
- Narrow Gapped Packet Read Schedule (PRS)
- Block Packing Mode (BPM) for widest compatibility
- Audio: single monitor 2.0 stereo Audio 48 kHz sampling 24-bit 2022-7 Flow pair with choice of ST 2110-30 or ST 2110-31 with 1 ms or 125 µs Packet Time
- Audio selection follows the selected, Post Volume Fader, 2.0 Stereo or 1.0 Dual Mono audio meter monitored audio.

Reviewing the Tx tab

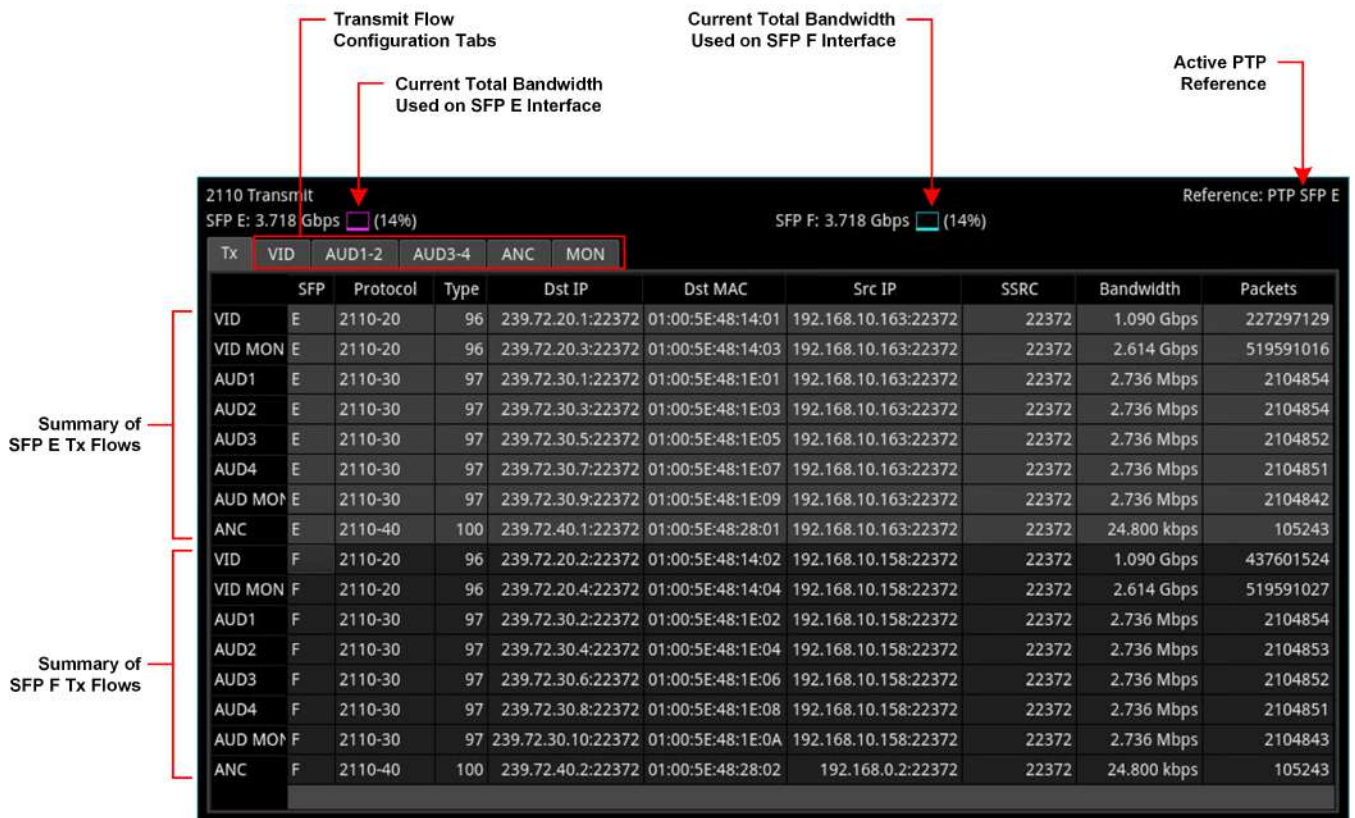

Figure 6-32: 2110 Transmit - Tx Tab

Use this tab as an overview of all flows actively being transmitted from the unit, together with the active PTP reference and an indication of bandwidth used by each interface module.

The **Tx** tab displays current status information about the following flows:

- **VID:** Transmission details of the video flow originating from the Test Pattern Generator (TPG).
- **VID MON:** Transmission details of the video flow originating from the unit's Monitor display.
- **AUD1/2/3/4:** Transmission details of the AUD1 to AUD4 flows from the Audio Generator.
- **ANC:** Transmission details of the ANC flow from the Timecode Generator.
- **AUD MON:** Transmission details of the audio flow originating from the unit's Monitor display.

The columns in the overview table of the **Tx** tab are as follows:

- **SFP:** The selected SFP interface for that Flow.
- **Protocol** The active SMPTE 2110 protocol of the flow.
- **Type:** The payload type of the flow.
- **Dst IP:** Destination IP address and UDP port of the flow.
- **Dst MAC:** Destination MAC address (Hex).
- **Src IP:** Source IP address and UDP port of the flow.
- **SSRC:** Synchronization source identifier used as a unique identifier of the flow source.
- **Bandwidth:** Displays the current bandwidth used by each flow. In addition, the total current bandwidth used by each interface module is displayed in the instrument header.
- **Packets:** Transmitted packet count for each flow.

You can change these parameters for any of the flows by selecting **Configure Tx Flows...** from the options menu. You can also reset the packet count to zero by selecting **Clear Packet Counts** from the options menu.

At the top-right of the screen the reference indicator shows which of the PTP engines is currently active, for example, **Reference: PTP SFP E**. When displayed in white text, the unit is correctly locked to either the PTP Engine on SFP E or SFP F.

If displayed as **Free Run** in red text, the unit is set to Free Run and a PTP source has not been selected in the **Video Timing & System Reference** instrument. This is an important warning as the 2110 transmit flows are only valid when the unit is locked to either of the SFP E or F PTP Engines.

Reviewing the VID Tab

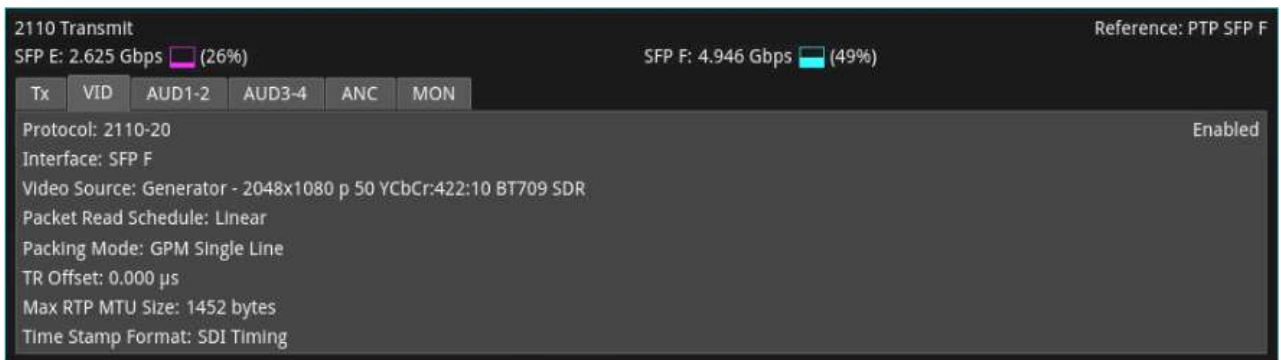

Figure 6-33: 2110 Transmit - VID Status Tab

The **VID** tab displays the active settings for the Video Generator flows, as follows:

- **Protocol:** Displays the active SMPTE 2110 video protocol SMPTE 2110-20
- **Interface:** Displays the active interface for transmission of the video flow.
- **Video Source:** Identifies the selected video standard from the Video Generator.

- **Packet Read Schedule:** Displays the active packet read schedule for SMPTE 2110-21 - either Gapped or Linear.
- **Packing Mode:** Displays the active packing mode: General Packing Mode (GPM) (single- or multi-line) or Block Packing Mode for the RTP payload being transmitted.
- **TR Offset:** Definition of the egress time of the flow with respect to the local PTP Frame time.
- **Max RTP MTU Size:** Maximum size (maximum transmission unit) of the RTP packet for information only. The MTU size is defined as the UDP payload size (RTP Header plus RTP Payload).
Note: The standard UDP size limit of 1460 octets defined in 2110-10 is a combination of the UDP Header + RTP Header + 2120-20 Header + RTP Payload (see *2110-10 Section 6.3*).

You can change settings by selecting **Configure Tx Flows...** from the options menu.

Reviewing the AUD1-2 and AUD3-4 Tabs



Figure 6-34: 2110 Transmit - AUD1-2 Status Tab

For each of the Generator audio flows, the **AUD1-2** and **AUD3-4** tabs display the active settings for the transmitted Generator audio flows, as follows:

- **Protocol:** Displays the active SMPTE 2110 audio protocol 2110-30 or 2110-31.
- **Packet Time:** Displays the packet time as either 1 ms or 25 μ s, depending on the configured protocol and number of channels.
- **Channels:** Displays the number of audio channels being transmitted. Level C Audio operation supports up to 80 channels at 125 μ s and 10 channels at 1 ms packet time (ST 2110-30), and up to 60 channels at 125 μ s and 7 channels at 1 ms packet time (ST 2110-31).
- **Audio Source:** Displays the source of the audio flows, either Generator or Audio Meter.

You can change these settings by selecting **Configure Tx Flows...** from the options menu.

Reviewing the ANC Tab

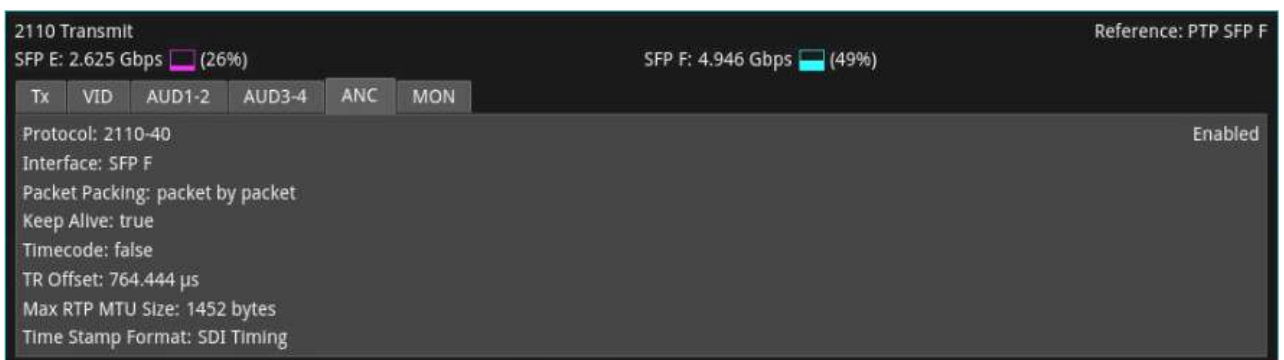

Figure 6-35: 2110 Transmit - ANC Status Tab

The **ANC** tab displays the active settings for the Video Generator flows, as follows:

- **Protocol:** Displays the active SMPTE 2110 ANC protocol SMPTE 2110-40
- **Interface:** Displays the active interface for transmission of the ANC flow.
- **Packet Packing:** Selected packing mode of the ANC flow.
- **Keep Alive:** Select to enable the generation of Keep Alive Packets (true) or disable the generation of Keep Alive Packets (false). **Timecode:** Definition of the timecode parameters from the Timecode Generator
- **TR Offset:** Definition of the egress time of the flow with respect to the local PTP Frame time.

You can change these settings by selecting **Configure Tx Flows...** from the options menu and expanding the ANC section.

Reviewing the MON Tab

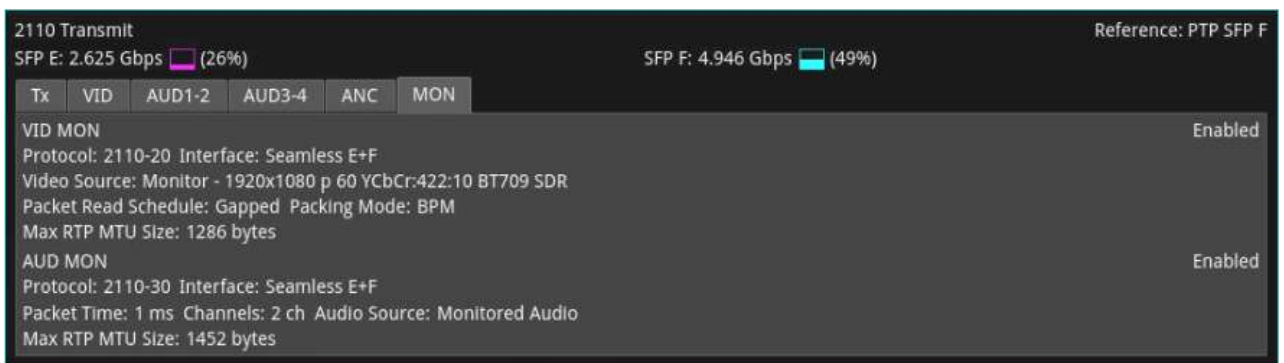

Figure 6-36: 2110 Transmit - MON Status Tab

The **MON** tab displays the active settings for transmission of the Monitor flows, as follows:

VID MON Section:

- **Protocol:** Displays the active ST 2110 video protocol SMPTE ST 2110-20
- **Interface:** Displays the active interface for output of the video flow.
- **Video Source:** Identifies the selected video monitor, together with resolution, frame rate, color space, etc.
- **Packet Read Schedule:** Displays the active packet read schedule for SMPTE ST 2110-21 - Gapped only.

AUD MON Section:

- **Protocol:** Displays the active packet read schedule for SMPTE ST 2110-21 - Gapped only.
- **Interface:** Displays the active interface for output of the audio flow.
- **Audio Source:** Displays the source of the audio flows as Monitored Audio.
- **Packet Time:** Displays the packet time as either 1 ms or 25 μ s, depending on the configured protocol and number of channels.
- **Channels:** Displays the number of SFP channels used for transmission: 2 channels.

You can change these settings by selecting **Configure Tx Flows...** from the Options menu.

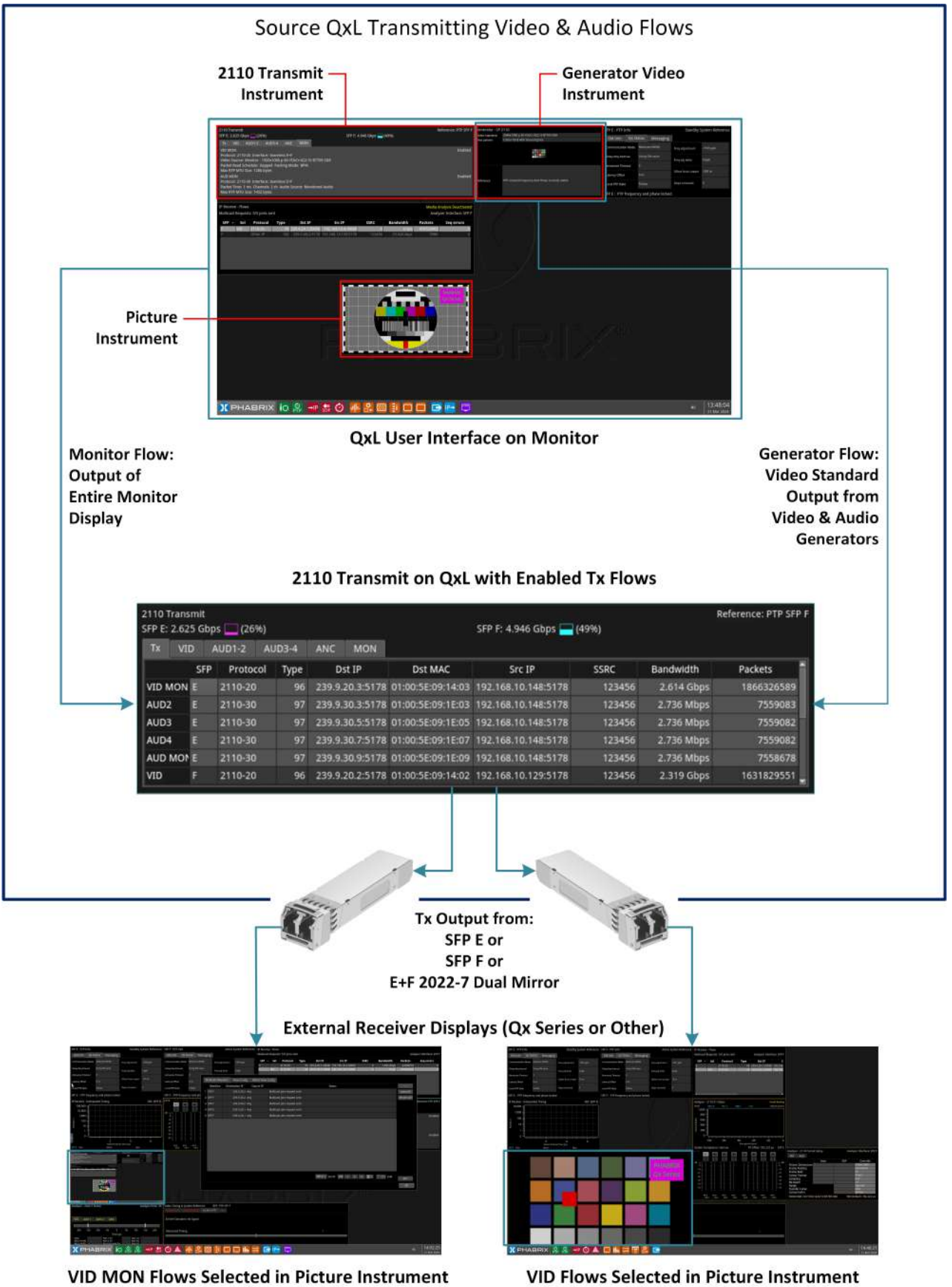

Figure 6-37: Schematic Overview of Transmission of Generator and Monitor Flows by the 2110 Transmit Instrument

Configuring the Generator Flows

The configuration screens are composed of a list of available flows displayed in an expandable list. Select a flow of interest and click the arrow to expand that item, displaying the configurable flow parameters. Each minimized flow provides a single line summary of the current settings for information. In addition, at the right-hand side of each flow is a dropdown list allowing you to enable or disable that particular flow.

Note: The use of unicast broadcast IP addresses for IP transmission is not currently permitted.

To configure the Generator Flows:

1. From any of the 2110 Transmit status tabs, right-click to open the Options menu.
2. Select the option: **Configure Tx Flows...**
3. Open the **GENERATOR** tab.
You will see the following screen displayed summarizing all the available flows and their current activity status.

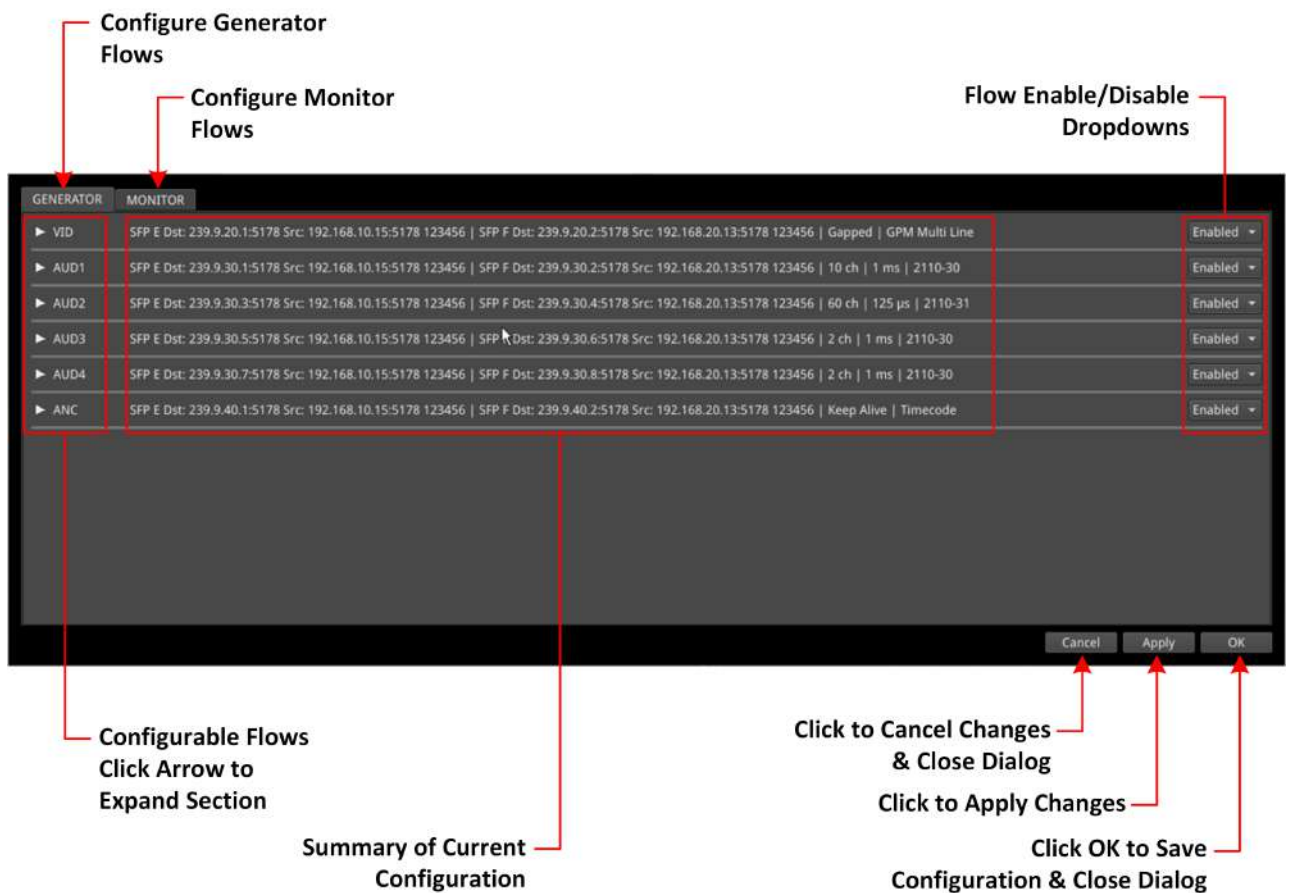

Figure 6-38: 2110 Transmit - GENERATOR Flows Configuration (All Flows Minimized)

4. Expand the flow you want to configure from: **VID, AUD1, AUD2, AUD3, AUD4, ANC.**
5. Enable or disable the flows as required using the dropdown box in the right-hand column.
6. Change the flow configurations as required by selecting the options described below.
7. Make sure you save your configuration changes by clicking either **Apply** to apply your changes but leave the dialog open or **OK** to accept your changes and close the configuration dialog. To close the dialog box without making any changes, either click Cancel, or left-click outside the dialog box.

Note: When NMOS is enabled the Generator configuration may be under NMOS control. The Generator Configuration dialog is updated with the current state on opening.

If you make a change in the Generator configuration dialog box and the Generator configuration is updated using the NMOS API, the NMOS configurations will be over-ridden by the manual configuration if you click **Apply** or **OK**.

Configuring the Generator Video Flows

When entering a numeric value in the configuration settings, you can use either a USB keyboard connected to the unit or the numeric keypad available by clicking the icon:

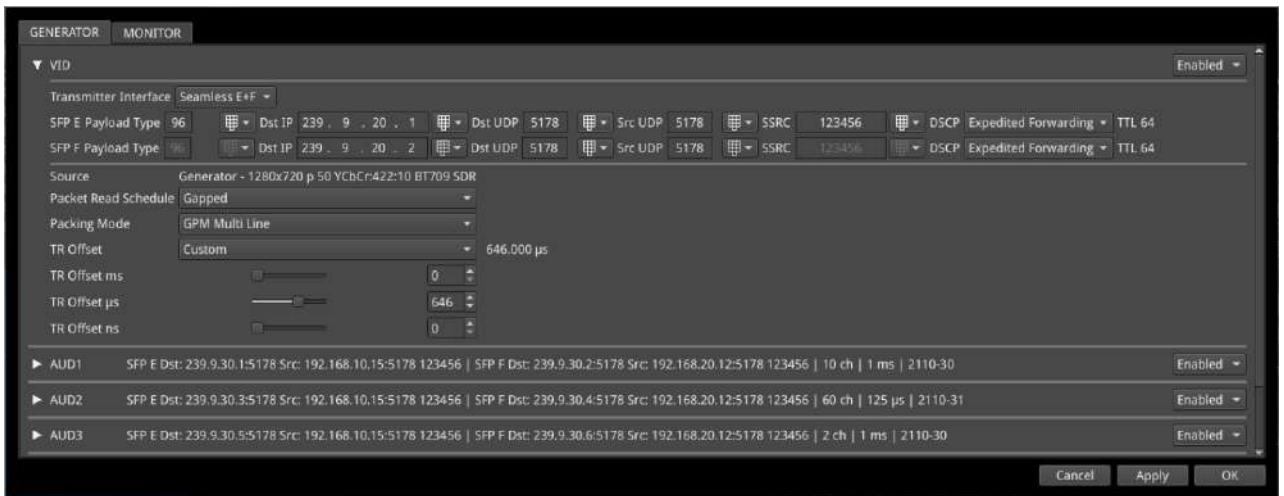

Figure 6-39: 2110 Transmit - Generator Video Flow Configuration

The following table lists the options available when configuring the Generator Video Flows:

Table 6-13 : 2110 Transmit - Generator Video Flow Options

Item	Options	Description
Transmitter Interface	Seamless E+F (Default) SFP E SFP F	The active interface for transmitting the Generator video flow. The Seamless E+F option provides two identical flows, according to 2022-7, to enable SIPS in the receiving device.
SFP E/F Payload Type	96 to 127	Defines the Real-time Transport Protocol (RTP) payload type for the video data packet. Default is 96 for 2110-20 Video, 97 for 2110-30/31 Audio, 98 for 2022-6 and 100 for 2110-40.
Dst IP	Numeric Entry	Destination IP address for the Tx flow; may be Multicast or Unicast. If Multicast the MAC address is calculated automatically from the IP address. If Unicast, then the unit will ARP the IP address to learn the MAC address automatically. If the MAC address cannot be obtained then the flow is not enabled.
Dst UDP	Numeric Entry	Destination UDP port for the Tx flow.

Item	Options	Description
Src UDP	Numeric Entry	Source UDP port for the Tx flow.
SSRC	Numeric Entry	Synchronization source identifier used as a unique identifier of the flow source.
Source	Video Standard selected in Generator Instrument	Test pattern video source details from the Generator instrument. Supports the following: Resolution: 1280x720, 1920x1080, 2048x1080. In addition when connected to a 25G network: 3840x2160 and 4096x2160 Color mapping: YCbCr:422:10 Frame Rates: 23.98p, 24p, 25p, 29.97p, 30p, 47.95p, 48p, 50p, 59.94p, 60p, 50i, 59.94i, 60i Color Space: SDR-709, SDR-2020, HDR-HLG, HDR-PQ, HDR-Slog3 For example: Generator - 1920x1080 p 50 YCbCr:422:10 BT709 SDR Optional bouncing box also supported.
Packet Read Schedule	Gapped (Default) Linear	Defines the active packet read schedule for SMPTE 2110-21, select either Gapped or Linear.
Packing Mode	GPM Single-line (Default) GPM Multi-line BPM	Defines the active packing mode either GPM (General Packing Mode) in single- or multi-line mode, or BPM (Block Packing Mode) for the RTP payload being transmitted.
TR Offset	Custom TRO Default (Default)	Defines the egress time of the flow with respect to the local PTP Frame time. The Default value ($TRO_{Default}$) is defined by ST 2110-21 and varies according to the selected Video format and Frame Rate. The Custom control allows you to adjust the egress time (and timestamp) with respect to the local PTP frame time from 0 ns up to 15 ms.

Click **Apply** to apply your configuration changes and continue configuring, or **OK** to save your changes and close the configuration dialog.

Configuring the Generator Audio Flows

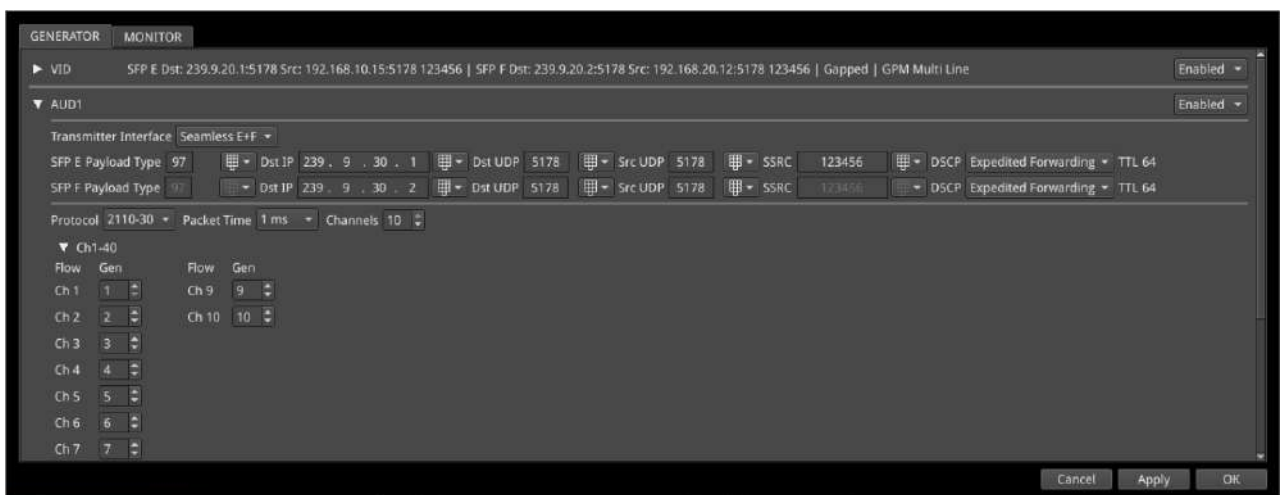

Figure 6-40: 2110 Transmit - GENERATOR Audio 1 Flow Configuration

The following table lists the options available when configuring the Generator Audio Flows:

Table 6-14 : 2110 Transmit - Generator Audio Flow Options

Item	Options	Description
Transmitter Interface	Seamless E+F (Default) SFP E SFP F	The active interface for transmitting the Generator audio flow. The Seamless E+F option provides two identical flows, according to 2022-7, to enable SIPS in the receiving device.
SFP E/F Payload Type	96 to 127	Defines the Real-time Transport Protocol (RTP) payload type for the audio data packet. Default is 96 for 2110-20 Video, 97 for 2110-30/31 Audio, 98 for 2022-6 and 100 for 2110-40.
Dst IP	Numeric Entry	Destination IP address for the Tx flow.
Dst UDP	Numeric Entry	Destination UDP port for the Tx flow.
Src UDP	Numeric Entry	Source UDP port for the Tx flow.
SSRC	Numeric Entry	Synchronization source identifier used as a unique identifier of the flow source.
Protocol	2110-30 2110-31	SMPT E protocol selected for the Generator audio flow.
Packet Time	1 ms 25 μ s	Defines the packet time as either 1 ms or 25 μ s, depending on the configured protocol and number of channels.
Channels	1 - 80 (Depending on selected Protocol and Packet Time)	Select the number of audio channels being transmitted. Level C Audio operation supports up to 80 channels at 125 μ s and 10 channels at 1 ms packet time (ST 2110-30), and up to 60 channels at 125 μ s and 7 channels at 1 ms packet time (ST 2110-31).

Complete the audio channel mapping matrix to map the Generator channels to the Generator audio channels to the 2110 Transmit channels.

Click **Apply** to apply your configuration changes and continue configuring, or **OK** to save your changes and close the configuration dialog.

Configuring the Generator ANC Flows

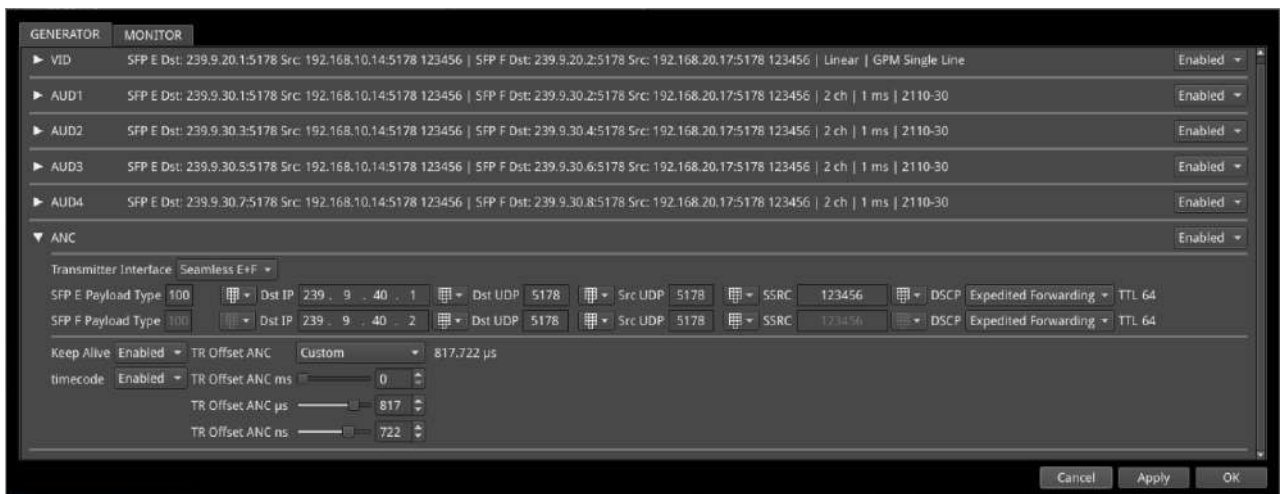

Figure 6-41: 2110 Transmit - GENERATOR ANC Flow Configuration

The following table lists the options available when configuring the Generator ANC Flows:

Table 6-15 : 2110 Transmit - Generator ANC Flow Options

Item	Options	Description
Transmitter Interface	Seamless E+F (Default) SFP E SFP F	The active interface for transmitting the Generator ANC flow. The Seamless E+F option provides two identical flows, according to 2022-7, to enable SIPS in the receiving device.
SFP E/F Payload Type	96 to 127	Defines the Real-time Transport Protocol (RTP) payload type for the ANC data packet. Default is 100 for 2110-40.
Dst IP	Numeric Entry	Destination IP address for the Tx flow.
Dst UDP	Numeric Entry	Destination UDP port for the Tx flow.
Src UDP	Numeric Entry	Source UDP port for the Tx flow.
SSRC	Numeric Entry	Synchronization source identifier used as a unique identifier of the flow source.
DSCP	Expedited Forwarding	Differentiated Services Code Point - packet header value used to request priority delivery.
Keep Alive	Enabled Disabled	Select to enable the generation of Keep Alive Packets (true) or disable the generation of Keep Alive Packets (false)
Timecode	Enabled Disabled	When enabled, uses the timecode from the Timecode Generator.
TR Offset ANC	Custom TRO Default (Default)	Defines the egress time of the flow with respect to the local PTP Frame time. The Default value ($TRO_{Default}$) is defined by ST 2110-40. The Custom control allows you to adjust the egress time (and timestamp) with respect to the local PTP frame time from 0 ns up to 15 ms.

Click **Apply** to apply your configuration changes and continue configuring, or **OK** to save your changes and close the configuration dialog.

If keep alive packets are present in the flow then the arrival time of the last data packet will be measured. If the video is interlaced there will be a values per field, else values per frame. A mean value for the last 1 second will be measured as well as historical min and max value.

Configuring the Monitor Flows

To configure the Monitor Flows:

1. From any of the 2110 Transmit status tabs, right-click to open the options menu.
2. Select the option: **Configure Tx Flows...**
3. Open the **MONITOR** tab.
You will see the summary screen displayed listing the available flows and their current activity status.
4. Expand the flow you want to configure from: **VID MON, AUD MON**.
5. Enable or disable the flows as required using the dropdown box in the right-hand column.
6. Change the flow configurations as required by selecting the options described below.

- Make sure you save your configuration changes by clicking either **Accept** to accept your changes but leave the dialog open or **OK** to accept your changes and close the configuration dialog.

Configuring the Monitor Video and Audio Flows

Configuration of the Monitor Video and Audio Flows is combined in this section as the Video Format 1920 x 1080 422:10 BT 709 SDR and the Frame Rate are imported directly from the Monitor Settings. The Packet Read Schedule and Packing Mode are fixed, by design, for the Monitor Flow and cannot be changed.

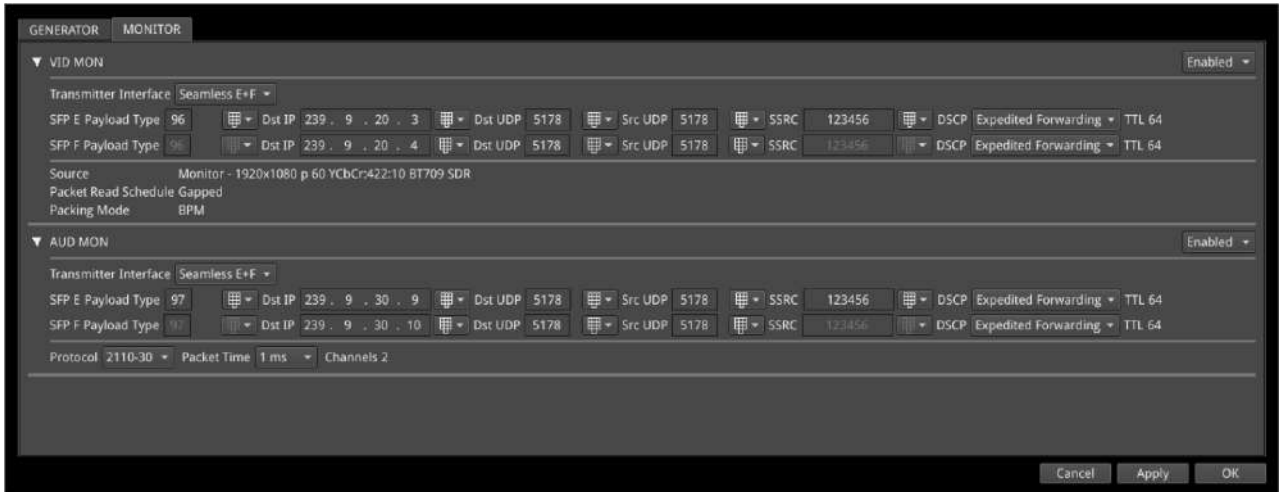

Figure 6-42: 2110 Transmit - MONITOR Video and Audio Flows Configuration

The following table lists the options available when configuring the Monitor Video and Audio Flows:

Table 6-16 : 2110 Transmit - Monitor Video and Audio Flow Options

Item	Options	Description
VID MON Options		
Transmitter Interface	Seamless E+F (Default) SFP E SFP F	The active interface for transmitting the Media video flow. Seamless E+F uses SMPTE 2022-7 SIPS.
SFP E/F Payload Type	96 to 127	Defines the Real-time Transport Protocol (RTP) payload type for the video data packet. Default is 96 for 2110-20 Video, 97 for 2110-30/31 Audio, 98 for 2022-6 and 100 for 2110-40.
Dst IP	Numeric Entry	Destination IP address for the Tx flow.
Dst UDP	Numeric Entry	Destination UDP port for the Tx flow.
Src UDP	Numeric Entry	Source UDP port for the Tx flow.
SSRC	Numeric Entry	Synchronization source identifier used as a unique identifier of the flow source.
Source	None	Transmission of the Monitor graphical user interface as a 2110-20 flow. Fixed settings taken directly from the configured monitor. For example: Monitor - 1920x1080 p 50 YCbCr:422:10

Item	Options	Description
		BT709 SDR
Packet Read Schedule	None	Defines the active packet read schedule for SMPTE 2110-21 Gapped only.
Packing Mode	None	Defines the active packing mode BPM (Block Packing Mode) for the RTP payload being transmitted.
AUD MON Options		
Transmitter Interface	Seamless E+F (Default) SFP E SFP F	The active interface for transmitting the Media audio flow. Seamless E+F uses SMPTE 2022-7 SIPS.
SFP E/F Payload Type	96 to 127	Defines the Real-time Transport Protocol (RTP) payload type for the audio data packet. Default is 96 for 2110-20 Video, 97 for 2110-30/31 Audio, 98 for 2022-6 and 100 for 2110-40.
Dst IP	Numeric Entry	Destination IP address for the Tx flow.
Dst UDP	Numeric Entry	Destination UDP port for the Tx flow.
Src UDP	Numeric Entry	Source UDP port for the Tx flow.
SSRC	Numeric Entry	Synchronization source identifier used as a unique identifier of the flow source.
Protocol	2110-30 2110-31	SMPTE protocol selected for the Media audio flow.
Packet Time	1 ms 25 μ s	Defines the packet time as either 1 ms or 25 μ s, depending on the configured protocol and channels.
Channels	None	The monitored audio pair from the audio meter window is transmitted as a 2 channel 2110-30/31 flow. This is the same audio as is output via the HDMI or SDI monitor out. Use the Monitor or Solo buttons in the Audio Meter instrument to control the audio signal transmitted in this flow. Use the Monitor button to select the audio pair underneath it. Use the Solo button to place the single channel into both channels of the flow. The level of this audio is controlled by the main volume controls of the unit. In addition, you also need to un-mute, the main volume control in order to include any audio in the Monitor Audio Flow.

Analysis Instruments

This chapter describes the analytical instruments provided with the unit and includes the following sections:

- [Analyzer - Video Standard \(SDI & 2022-6\)](#)
- [Stats - SDI in A, B, C, D](#)
- [Stats - 2022-6 Receive \(ST 2022-6 Input\)](#)

Analyzer - Video Standard (SDI & 2022-6)



Requires Option(s):	PHQXLO1-3G or PHQXLO1E-3G
---------------------	---------------------------

Overview

The **Analyzer - Video Standard (SDI & 2022-6)** instrument (for ST 2022-6 and optional SDI input) displays, by default, the payload details of the video input (ST 2022-6 IP or optional SD- or HD-SDI) being analyzed as described by the SMPTE ST 352 payload ID packets. The instrument then uses this data to identify the appropriate standard corresponding to the video input.

The instrument displays the payloads on the input signals for either ST 2022-6 SFPs (ST 2022-6 IP input) or SDI BNCs (SDI input (Factory Fitted Option)).

The entries in the Video Standard overview also summarize the current video standard in use, the status of ST 352 usage or any analyzer overrides already set, see [Figure 7-1](#).

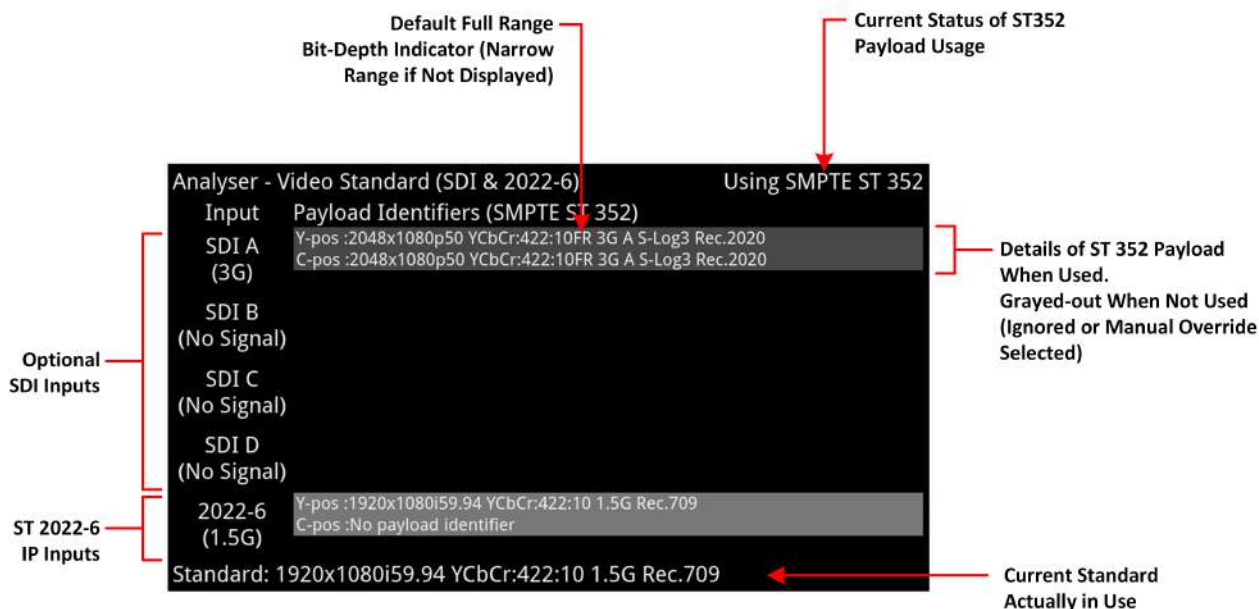

Figure 7-1: Analyzer - Video Standard (SDI & 2022-6) Instrument (Showing ST 2022-6 and Optional SDI Input)

Note: If the Video Standard (SDI & 2022-6) instrument is active but the unit is configured to analyze an ST 2110 IP input, you will see the following warning message displayed in the window:
Invalid Input.

To resolve, make sure that the input source is **ST 2022-6** or **SDI** as required, with the analyzer input set to **IP** or **SDI**, respectively.

If the instrument detects unstable ST 352 payloads or receives video input containing damaged or missing ST 352 packets, then it highlights errors using a red font and warnings in yellow.

Colorimetry Range and Bit Depth Support

From software version 5.4, the unit supports the automatic detection and analysis of SMPTE Full Range video standards in addition to SMPTE Narrow Range. The Qx Series of PHABRIX instruments uses the definitions for Narrow, Full Protected and Full Range as defined in SMPTE RP 2077 *Full-Range Image Mapping*.

Full, Protected and Narrow ranges for 10- and 12-bit depths, as implemented in the QxL, are summarized in the following table for ST 2022-6 IP or optional SDI input:

Range Type	SDI & IP 2022-6 Code Value Digital Representations	
	10-Bit Range	12-Bit Range
Full Range (FR)	N/A	N/A
Full Protected Range (FP)	1019	4079
Narrow Range (NR)	940	3760
↑ ↓	· · ·	· · ·
Narrow Range (NR)	64	256
Full Protected Range (FP)	4	16
Full Range (FR)	N/A	N/A

Figure 7-2: QxL Colorimetry Ranges (ST 2022-6 IP and Optional SDI)

Note: When analyzing a video input standard, the unit does not scale up from Protected Range to Full Range or scale down from Full Range to Protected Range.

If the incoming ST 352 (VPID) signals SMPTE Full Range, the unit will extract the bit depth Range parameter from the ST 352 payload and display the full range indicator (**FR**), by default, next to the bit depth parameter in the standard definition. If **FR** is not displayed in a standard definition, then the video signal being analyzed is SMPTE Narrow Range.

For example, you might see the detected standard defined as follows for a full range input:

1920 x 1080i150 YCbCr-422:10FR 1.5G Rec.2020

The active colorimetry range is also displayed in the definition for the standard currently in use at the bottom of the display.

For more information on video signal range definitions as implemented in the Qx Series, see the section [Video Range Definitions for the Qx Series](#).

Manual Configuration Override

You can configure manual overrides for a video standard by selecting **Manual Configuration...** from the options menu of the Video Standard instrument. Use this dialog to configure a standard manually, by selecting from the available options in each of the table columns, that you can use to override the standard automatically detected from the ST 352 payload.

To use the manual override instead of the auto-detected standard, select the option **Manual** from the **Payload Identifiers** dropdown in the options menu.

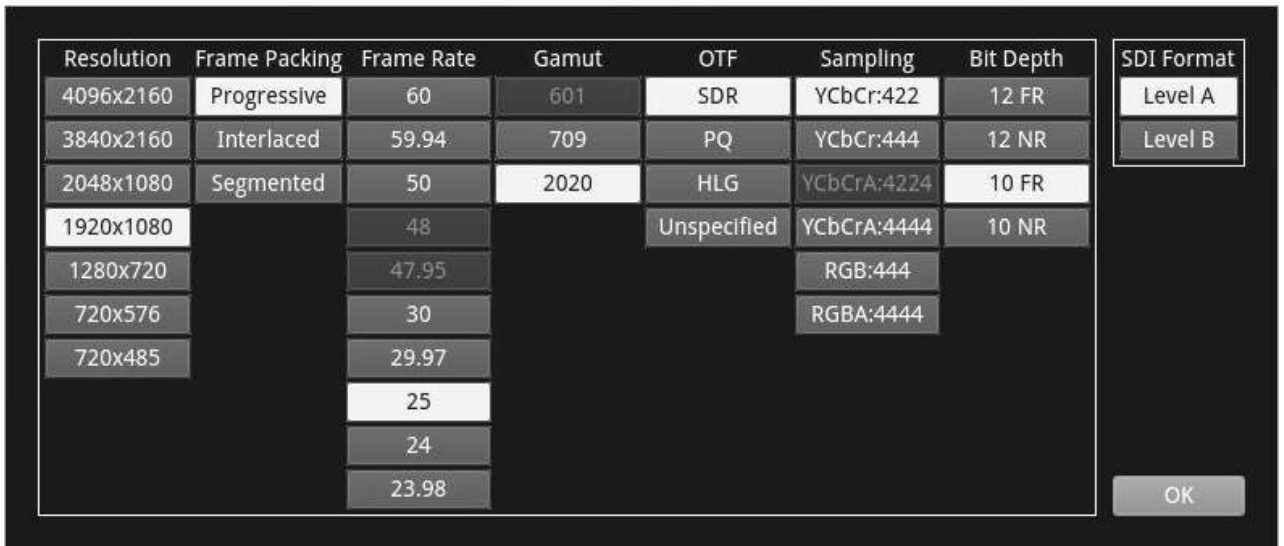

Figure 7-3: Analyzer - Video Standard Instrument - Manual Override Dialog (ST 2022-6 IP Input)

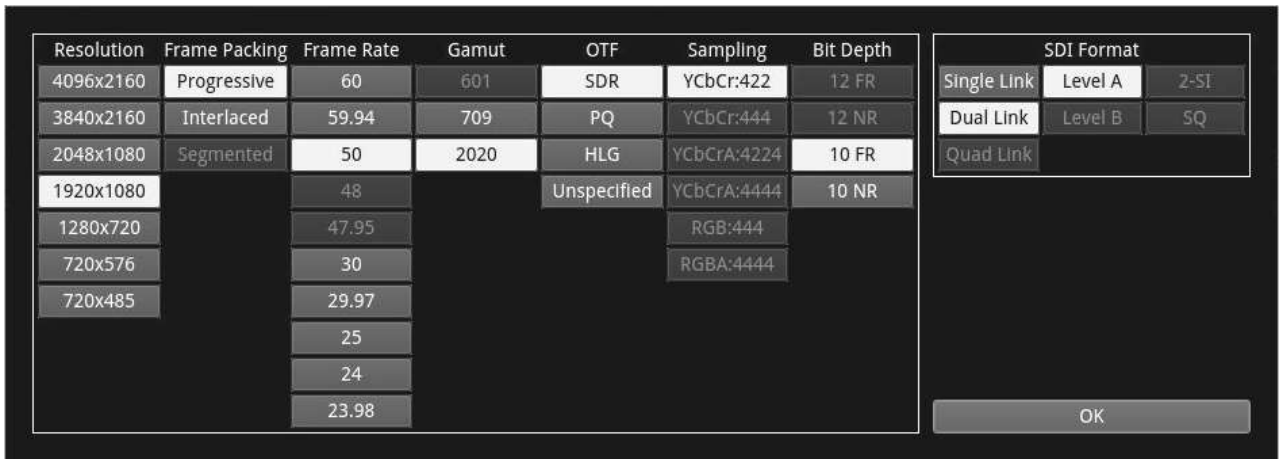

Figure 7-4: Analyzer - Video Standard Instrument - Manual Override Dialog (Optional SDI Input)

For the Manual Configuration override to be a compatible standard, the following criteria must be satisfied:

- The number of physical links are the same or less
- The number of sub-images are the same or less
- The incoming signal (as defined in the **Stats - SDI In** Instrument) and the manual configuration override standard have the same values for the following items:
 - Active Samples per Line
 - Active Lines per Field
 - Total Samples per Line
 - Total lines per Frame/Field1.

Changing the Payload Identification Source

In general, it is recommended to keep the default setting for the **Payload Identifiers** parameter **From S352** so that the unit automatically detects the video standard from the incoming ST 352 payload. In situations where the accuracy of incoming ST 352 packets cannot be relied upon, you can either force the instrument to use your manually-defined standard, by selecting the **Manual** option, or to ignore both the ST 352 payload *and* manual override by selecting **Ignored**.

Video input with ignored ST 352 packets is indicated in the top-right of the **Analyzer - Video Standard** window, see [Figure 7-5](#).

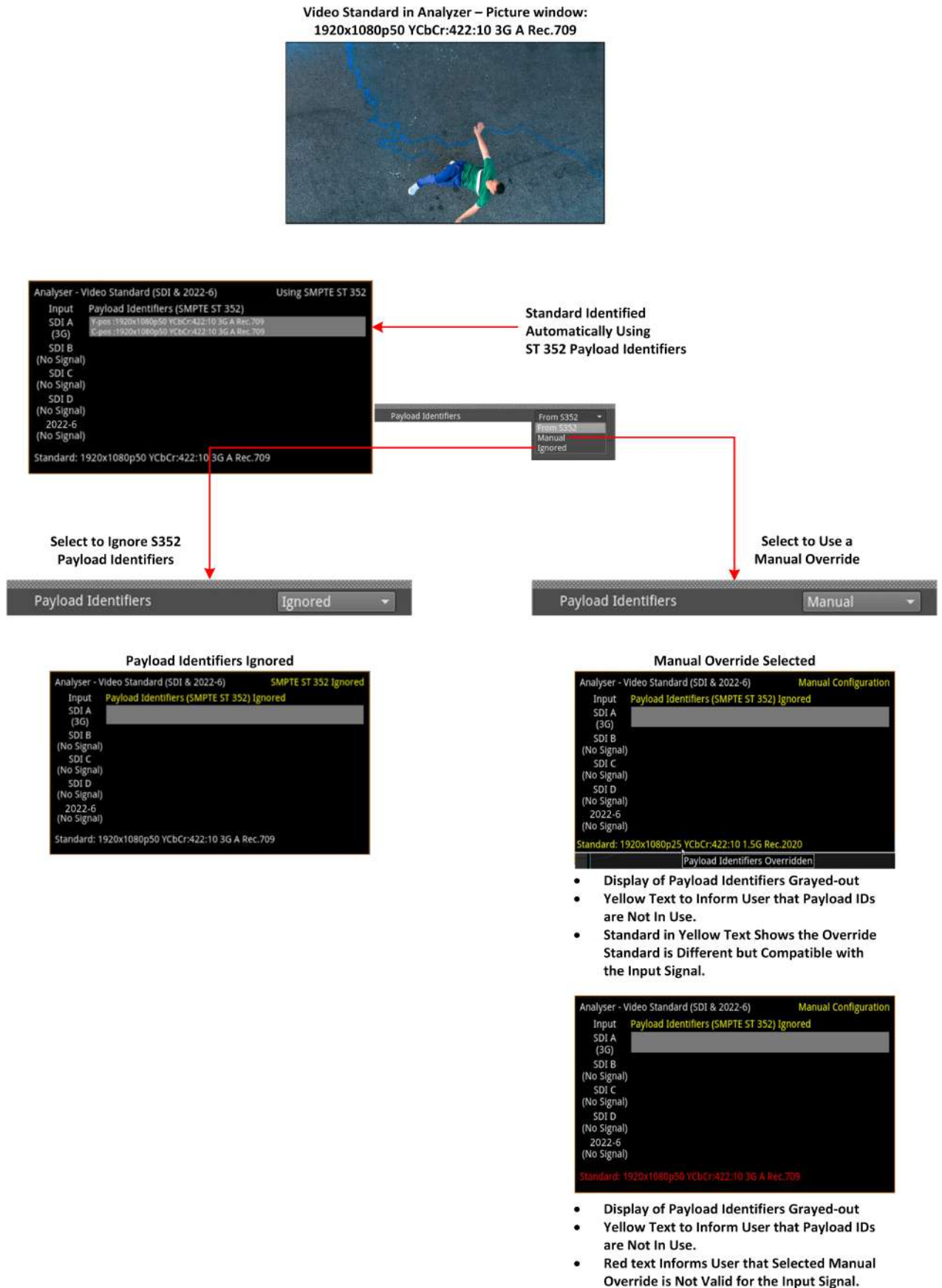

Figure 7-5: Analyzer - Video Standard Instrument with Warning and Error Displays (Optional SDI Input)

Instrument Menu Options

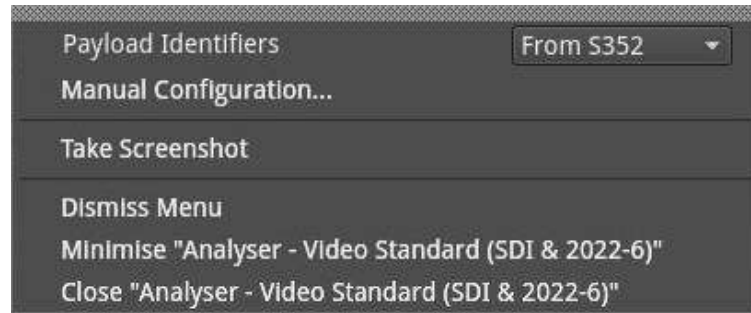

Figure 7-6: Analyzer - Video Standard Instrument - Options Menu

The following table lists the options available to configure the Analyzer - Video Standard (SDI & 2022-6) instrument:

Table 7-1 : Analyzer - Video Standard (SDI & 2022-6) Options

Item	Options	Description
Payload Identifiers	From S352 (Default) Manual Ignored	<p>By default, set to From S352, the instrument uses the SMPTE ST 352 payload identifiers in the incoming video signal to identify the video standard.</p> <p>When set to Ignored, ignores the ST 352 payload identifiers but instead uses firmware counters to attempt to identify the standard. As some features cannot be identified using this method (for example, gamut configuration) the Gamut is set to to 709 by default.</p> <p>When set to Manual, you can choose a manual override from the Manual Configuration... dialog. The instrument will warn you if the manual override is different but compatible with the incoming signal using yellow text or display an error in red text if the selected manual override is not valid for the incoming signal.</p>
Manual Configuration...	Instrument Control	Opens a manual override dialog enabling you to select the various parameters defining the video standard. If you select a parameter which is incompatible, the text of the column heading containing the incompatible parameter changes color to yellow.

Stats - SDI In A, B, C, D (Optional SDI Input)



Requires Option(s):	PHQXLO1-3G or PHQXLO1E-3G (Factory-fitted)
---------------------	--

Overview

The **Stats - SDI In A, B, C and D** window provides information to verify the format of the signal(s) being analyzed, and input cable length information. A video signal may comprise either a single SD-SDI signal on **SDI In A** only, or up to up to four separate HD-SDI signals on **SDI In A, B, C or D** each providing a sub-image.

Stats - SDI In A		270M Signal	
Data Rate: 270.000 MHz	Clock Divisor: 1.000	Cable Length: <50m	
	Sub Image 1		
Counters Stable	true		
Active Samples Per Line	720		
Active Lines Per Field	244		
Total Samples Per Line	858		
Total Lines Frame/Field1	262		
Total Lines Field2	263		
Payload ID Y-Pos	unnecessary		
Payload ID C-Pos	81 06 00 01		

Figure 7-7: Stats - SDI In A: Displaying Data from Single SD (270M) Input on SDI In A

Stats - SDI In A		12G Signal			
Data Rate: 11.880000 GHz	Clock Divisor: 1.000	Cable Length: 21m			
	Sub Image 1	Sub Image 2	Sub Image 3	Sub Image 4	
Counters Stable	true	true	true	true	
Active Samples Per Line	2048	2048	2048	2048	
Active Lines Per Field	1080	1080	1080	1080	
Total Samples Per Line	2640	2640	2640	2640	
Total Lines Frame/Field1	1125	1125	1125	1125	
Total Lines Field2	progressive	progressive	progressive	progressive	
Payload ID Y-Pos	CE C9 40 01	CE C9 40 01	CE C9 40 01	CE C9 40 01	
Payload ID C-Pos	CE C9 40 01	CE C9 40 01	CE C9 40 01	CE C9 40 01	

Figure 7-8: Stats - SDI In A: Displaying Data from Single 12G Input on SDI In A

Stats - SDI In A		3G Signal	Stats - SDI In B		3G Signal
Data Rate:	2.967033 GHz	Clock Divisor: 1.001	Cable Length: 1m	Data Rate:	2.967033 GHz
				Clock Divisor: 1.001	Cable Length: 0m
	Sub Image 1			Sub Image 1	
Counters Stable	true			Counters Stable	true
Active Samples Per Line	4096 (B mux)			Active Samples Per Line	4096 (B mux)
Active Lines Per Field	540			Active Lines Per Field	540
Total Samples Per Line	5500 (B mux)			Total Samples Per Line	5500 (B mux)
Total Lines Frame/Field1	563			Total Lines Frame/Field1	563
Total Lines Field2	562			Total Lines Field2	562
Payload ID Y-Pos LinkA	8A 44 40 01			Payload ID Y-Pos LinkA	8A 44 40 01
Payload ID C-Pos LinkA	unnecessary			Payload ID C-Pos LinkA	unnecessary
Payload ID Y-Pos LinkB	8A 44 40 41			Payload ID Y-Pos LinkB	8A 44 40 41
Payload ID C-Pos LinkB	unnecessary			Payload ID C-Pos LinkB	unnecessary
Stats - SDI In C		3G Signal	Stats - SDI In D		3G Signal
Data Rate:	2.967033 GHz	Clock Divisor: 1.001	Cable Length: 1m	Data Rate:	2.967033 GHz
				Clock Divisor: 1.001	Cable Length: 1m
	Sub Image 1			Sub Image 1	
Counters Stable	true			Counters Stable	true
Active Samples Per Line	4096 (B mux)			Active Samples Per Line	4096 (B mux)
Active Lines Per Field	540			Active Lines Per Field	540
Total Samples Per Line	5500 (B mux)			Total Samples Per Line	5500 (B mux)
Total Lines Frame/Field1	563			Total Lines Frame/Field1	563
Total Lines Field2	562			Total Lines Field2	562
Payload ID Y-Pos LinkA	8A 44 40 01			Payload ID Y-Pos LinkA	8A 44 40 01
Payload ID C-Pos LinkA	unnecessary			Payload ID C-Pos LinkA	unnecessary
Payload ID Y-Pos LinkB	8A 44 40 41			Payload ID Y-Pos LinkB	8A 44 40 41
Payload ID C-Pos LinkB	unnecessary			Payload ID C-Pos LinkB	unnecessary

Figure 7-9: Stats - SDI In A / B / C / D: Displaying Data from Quad 3G Input in Four Windows

Stats - 2022-6 Receive (ST 2022-6 Input)



Overview

The **Stats - 2022-6 Receive** window provides information to verify the format of the signal being analyzed when receiving ST 2022-6 IP input on **SFP E** or **SFP F**.

Stats - 2022-6 Receive		1.5G Signal
Clock Divisor: 1.001		
Sub Image 1		
Counters Stable	true	
Active Samples Per Line	1920	
Active Lines Per Field	540	
Total Samples Per Line	2200	
Total Lines Frame/Field1	563	
Total Lines Field2	562	
Payload ID Y-Pos	85 06 00 01	
Payload ID C-Pos	unnecessary	

Figure 7-10: Stats - 2022-6 Receive Instrument

Note: If the Stats - 2022-6 Receive instrument is active but the unit is configured to analyze either an ST 2110 IP or optional SDI input, you will see the following warning message displayed in the window: **Invalid Input**.

To resolve, make sure that the analyzer input is set to **IP** and that the input source is **ST 2022-6**.

Network Analysis Instruments

This chapter describes Instruments for the analysis of the network quality and includes the following sections:

- [Analyzer - 2022-7 Status \(IP Input\)](#)
- [SFP \(E, F\) - Network Stats](#)

Analyzer - 2022-7 Status (ST 2022-6 or ST 2110 IP Input)



Overview

Transmitting each media stream across dual, fully-redundant networks or links enables receivers / decoders to use ST 2022-7 Seamless IP Protection Switching (SIPS). This provides perfect error-free transport even in the case of severe packet loss or link outages as long as one good packet arrives within a certain time window on either of the two network links. Depending on the receiver buffer size and desired maximum latency, an individual decoder is designed to accommodate a specific, maximum time difference between incoming packets, or *skew*, between the two flows.

The **Analyzer - 2022-7 Status** instrument provides an indication of the health of each ST 2022-7 flow pair and the skew between their incoming packets, depending on the selected receiver classification, as selected in the instrument menu options.

A negative skew value indicates that packets on SFP E interface have arrived first. A positive skew value indicates that packets on the SFP F interface have arrived first.

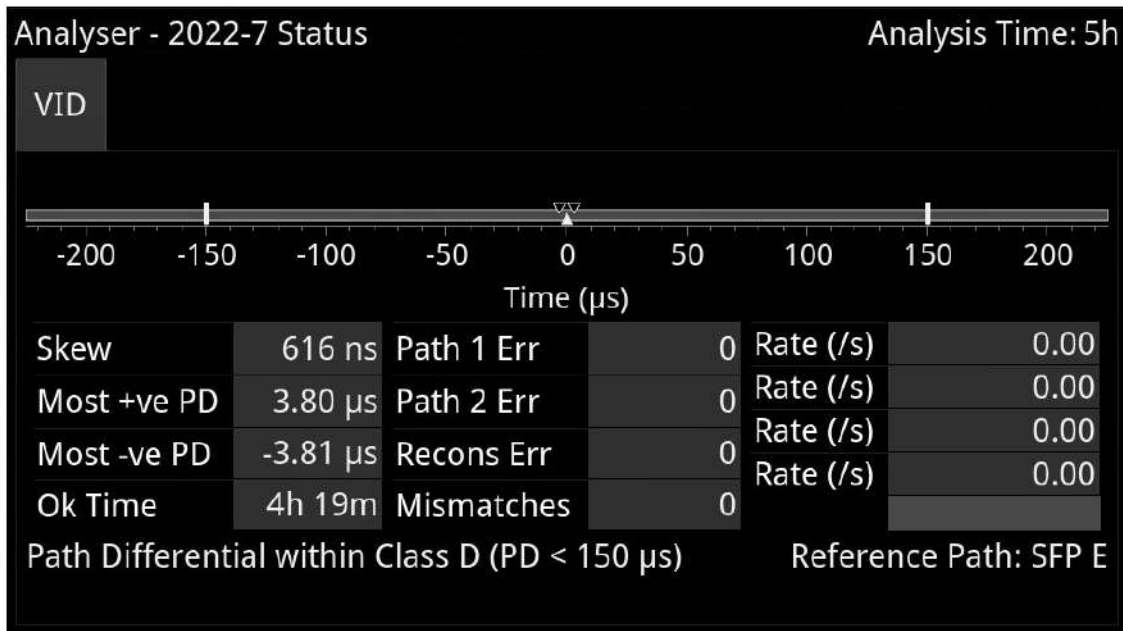

Figure 8-1: Analyzer - 2022-7 Status Instrument (ST 2022-6 IP Input)



Figure 8-2: Analyzer - 2022-7 Status Instrument (ST 2110 IP Input)

Note: If the 2022-7 Status instrument is active but the unit is configured to analyze an optional SDI input, you will see the following warning message displayed in the window: **Invalid Input**.

To resolve, make sure that the analyzer input is set to **IP** and that the input source is either **ST 2022-6** or **ST 2110**.

For an ST 2110 IP input, double-click the instrument to display all four flows in 1/4 display size as shown above. Double-click again to reduce to 1/16 display size, with a tab to display each flow. Each tab will change color to yellow or red to provide a quick indication of a warning or an error respectively. One video flow, two audio flows, and a single ancillary flow are available for selection.

Note: Monitoring of audio flows **AUD 3** and **AUD 4** is not supported in the current software release.

Features include:

- Indication of the health of ST 2022-7 seamless protection
- Warning of ST 2022-7 flow-pair mismatch
- Warnings of errors on flows and errors on reconstructed output and error rates per second
- Relative measure of Path Differential (Skew) of flows on **SFP F** (Blue Network) relative to **SFP E** (Amber Network), with Class A, B, C, D markers.

The error counters in the reporting table, below the timing meter, display the following information:

- **Path 1 Err** and **Path 2 Err** report the number of missing and/or corrupt packets detected on each path. When the unit detects a missing or corrupt packet it increments the counter.
- **Recons Err** is incremented when the instrument detects that a pair of matched packets is missing and/or corrupt. A *matched packet* is the same, corresponding packet, transported on paths 1 and 2.
- **Mismatches** reports the number of pairs of matched packets in which the payload of each is different, indicating a potential problem with the flow source rather than the network.

Instrument Menu Options

The following table lists the options available in the Analyzer - 2022-7 Status instrument submenu:

Table 8-1 : Analyzer - 2022-7 Status Options

Item	Options	Description
Receiver Classification	Class A Class B Class C Class D	Class A: Low-Skew ≤ 10 ms Class B: Moderate-Skew ≤ 50 ms Class C: High-Skew ≤ 450 ms for flows under 270 Mb/s and <150 ms for flows ≥ 270 Mb/s Class D: Ultra Low-Skew <150 μ s
Reset errors and running time	Instrument Control	Resets any errors that have occurred during the running period and sets the running time back to zero.

Note: Set the video frame rate correctly in the **Analyzer - 2110 Format Setup** instrument to ensure accurate video skew measurements.

SFP (E, F) - Network Stats



Overview

The **Network Stats** instrument displays transmission and reception traffic information, detailing the type and number of packets sent and received by an SFP. CRC errors are identified and packet sequence errors reported. In addition, the instrument displays the network link speed (10 Gb or 25 Gb) and current forward error correction mode in the top-right corner of the window.

Note: When using forward error connection, you will need to ensure that you have configured the correct FEC type on both the IP Switch and the unit. The unit supports either IEEE 802.3 Clause 108 by Reed Solomon FEC (RS-CL108) for 25G ports, or no FEC (NO-FEC) without auto-negotiation. The QxL default is to use RS-CL108.

The IP switch interface should be configured to use RS-CL108 with FEC auto-negotiation disabled to provide the highest possible level of data integrity on the 25G links.

SFP E - Network Stats	Link Speed: 25Gb	FEC Mode: RS-CL108
	Rx Cumulative	Tx Cumulative
Packets:	116793480	110623081
Good Packets:	116793480	110623081
Bytes:	149861202017	140047447563
Bad FCS:	0	N/A
Multicast:	116793465	110623042
Unicast:	14	29
Broadcast:	1	10
VLAN:	0	0

Figure 8-3: SFP E - Network Stats Instrument (1/16 Screen Size)

Double-clicking the window expands it to quarter screen size to display additional packet information.

Note: If you insert a 25G SFP in either the **SFP E** or **SFP F** module cages when the 25G IP license (**PHQXLO-IP-25G**) is not installed, the Instrument title will change color to red. If you hover the cursor over the title the following error message is displayed:

Error: IP 25G License: Not Present. Inserted 25G SFPs will not function.

SFP E - Network Stats		Link Speed: 25Gb	FEC Mode: RS-CL108
	Rx Cumulative	Tx Cumulative	
Packets:	122033661	115457221	
Good Packets:	122033661	115457221	
Bytes:	156584934460	146167412499	
Bad FCS:	0	N/A	
Multicast:	122033646	115457182	
Unicast:	14	29	
Broadcast:	1	10	
VLAN:	0	0	
Packets by size (bytes):			
64:	664	41	
65 to 127:	74196	1169	
128 to 255:	1107	1	
256 to 511:	0	8	
512 to 1023:	28141257	28864000	
1024 to 1518:	93816437	86592002	
1519 to 1522:	0	0	
1523 to 1548:	0	0	
1549 to 2047:	0	0	
2048 to 4095:	0	0	
4096 to 8191:	0	0	
8192 to 9215:	0	0	
FEC Corrected:	0	N/A	
FEC Uncorrected:	0	N/A	

Figure 8-4: SFP E - Network Stats Instrument (1/4 Screen Size)

Two counters at the bottom of the expanded Network Stats window display the FEC Corrected and FEC Uncorrected packet counts. If forward error correction is disabled in the options menu (NO-FEC), then these counters both display: N/A.

Instrument Menu Options

The options menu allows you to enable or disable forward error correction.

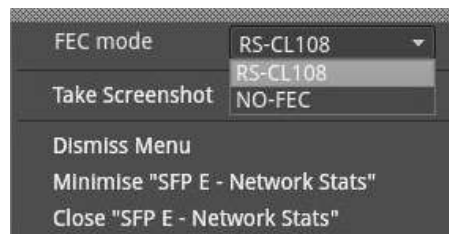

Figure 8-5: SFP E/F - Network Stats Instrument Options Menu

The following table lists the options available in the SFP E/F - Network Stats instrument submenu:

Table 8-2 : SFP E/F - Network Stats Options

Item	Options	Description
FEC mode	RS-CL108 (Default) NO-FEC	RS-CL108: Enable Reed Solomon Forward Error Correction, IEEE 802.3 Clause 108 - this is the default mode of the unit. NO-FEC: Disable Forward Error Correction if network equipment does not support Reed Solomon FEC.

Note: Firecode/Base-R forward error correction is not currently supported by the unit.

Content Analysis Instruments

This chapter describes the Instruments used to analyze the quality of the video signal and includes the following sections:

- [Analyzer - Picture](#)
- [Analyzer - Waveform](#)
- [Analyzer - Vectorscope](#)
- [Analyzer - CRC Analysis](#)



Overview

The **Picture** view shows the video input or generator pattern currently being analyzed by the unit. Double-click anywhere in the window to resize the view between:

- One sixteenth (1/16) of the screen
- One quarter (1/4) of the screen
- Full screen.

Some features of the Picture instrument are dynamically linked to the Dataview and Waveform analyzer instruments to enable more precise analysis of the picture.

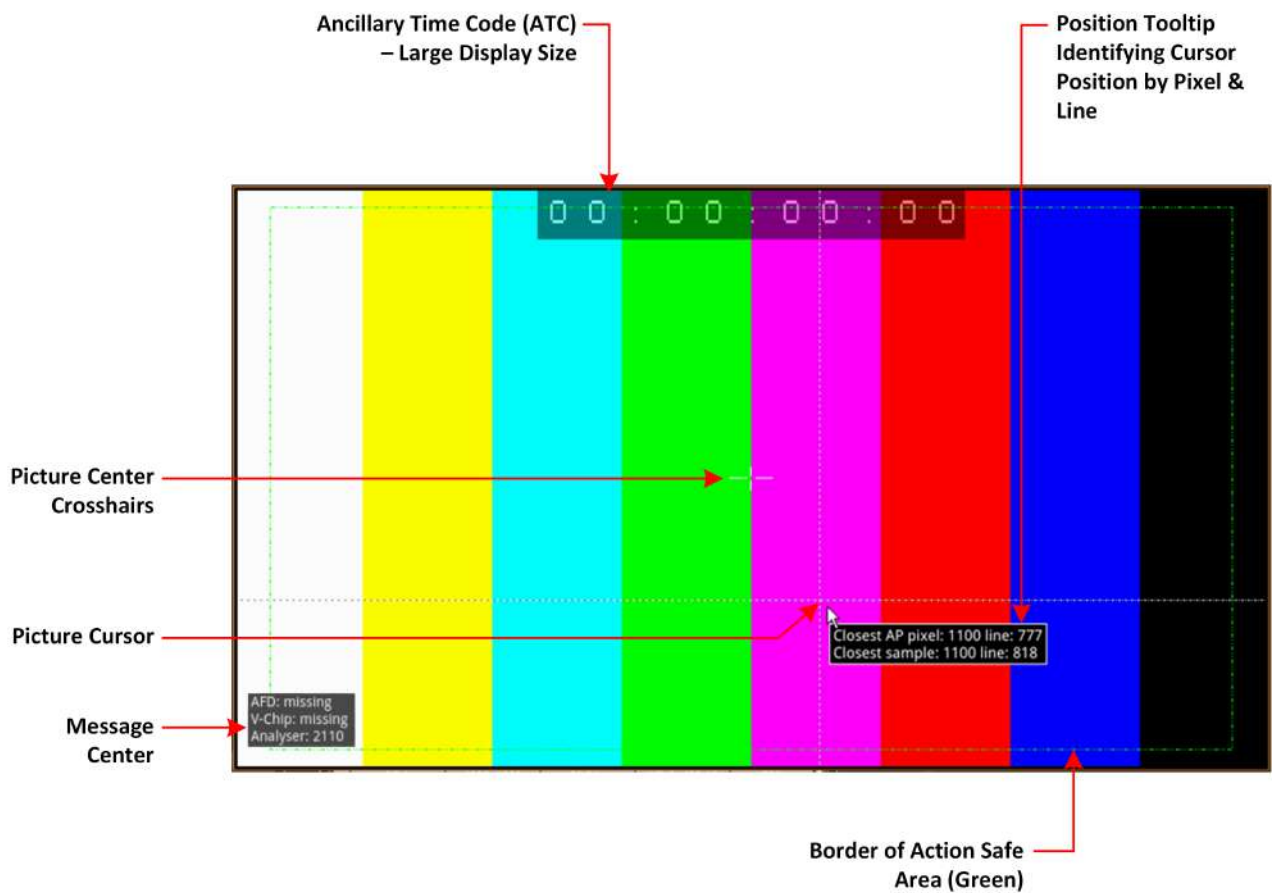

Figure 9-1: Components of the Analyzer - Picture Instrument

In addition to displaying the video picture, you can configure the Picture instrument to overlay various data elements, extracted from the ancillary data in the video signal, for quality control purposes, including:

- Closed Captions
- Ancillary Time Code (ATC)
- Picture Cursor and Position Tooltip
- Picture Safe Areas
- Picture Center Crosshairs

- Message Center displaying V-chip, AFD, Input Name, ST309 Date, Analyzer Source input, and SCTE104 data (depending on configuration)
- HDR False Color Overlay and Grayscale Mode (HDR Mode Only). See the section [HDR Heat-map \(False Color Overlay\)](#) for more information.

Picture Aspect Ratios

With support for the input of SD-SDI video, the Picture and Picture - Copy windows now feature improved scaling, which applies to all supported aspect ratios. These scaling improvements enable the source video input to fill the standard 1920 x 1080 (16:9) Picture window with the maximum possible image size.

To scale an image to fit the window correctly, where appropriate, the unit will automatically insert borders either at the top and bottom sides of the window - referred to as **Letter-boxing** - or at the left and right sides of the window - referred to as **Pillar-boxing**, see [Figure 9-2](#).

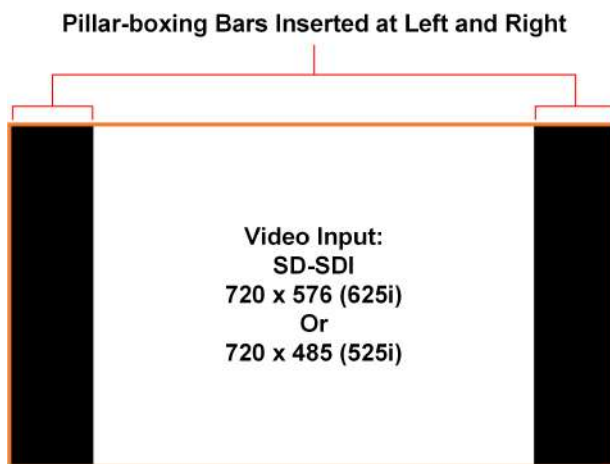
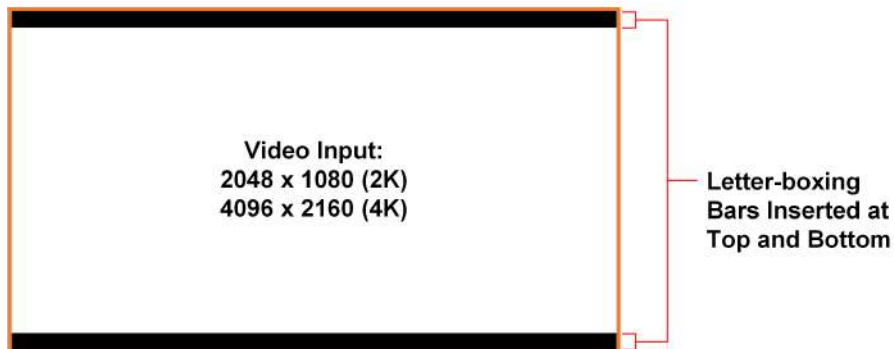
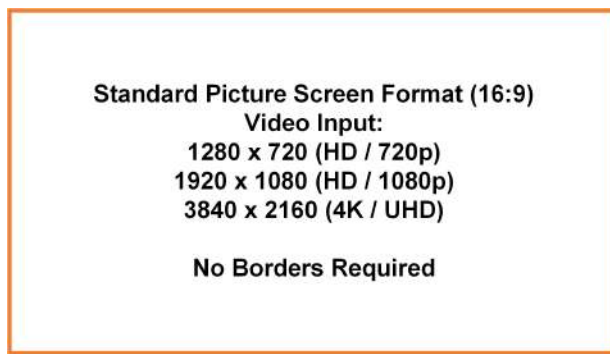

Figure 9-2: Letter-boxing and Pillar-boxing in Picture Instrument

The following table shows where pillar-boxing and letter-boxing borders are required:

Table 9-1: Picture Framing by Screen Resolution

Screen Resolution	Type of Picture Framing Required
SD-SDI 525i: 720 x 485	Scaled to a 4:3 aspect ratio. Pillar-box borders added to left and right sides
SD-SDI 625i: 720 x 576	Scaled to a 4:3 aspect ratio. Pillar-box borders added to left and right sides
1280 x 720	Scales to fit 16:9 aspect ratio of Picture window. No additional borders required.

Screen Resolution	Type of Picture Framing Required
1920 x 1080	Scales to fit 16:9 aspect ratio of Picture window. No additional borders required.
2048 x 1080	Scaled to a 16:9 aspect ratio. Letter-box borders added to top and bottom sides
3840 x 2160	Scales to fit 16:9 aspect ratio of Picture window. No additional borders required.
4096 x 2160	Scaled to a 16:9 aspect ratio. Letter-box borders added to top and bottom sides

Instrument Menu Options

Closed Captions	OP47
OP47 Page	888
OP47 Show Unboxed	Disabled
Picture Cursor	Enabled
Line	122
Pixel	140
Anc Time Code	Enabled
Anc Time Code Type	VITC
Anc Time Code Size	Small
Anc Time Code Position	Bottom
Anc Time Code Field	Disabled
Action Safe Area	Enabled
Graphics Safe Area	Disabled
4x3 Safe Area	Disabled
Custom Safe Area	Disabled
Crosshair	Enabled
Message Centre	Top Left
Transparency	Disabled
Message Timeout	10 s
AFD	Disabled
Vchip	Disabled
St309 Date	Disabled
Analyser Source	Enabled
SCTE104 Detection	Disabled
Input Name	Enabled
Input Name Configuration...	
On Video Loss	Black Screen
Greyscale mode	Disabled
False Colour Highlighting	Disabled
Take Screenshot	
Dismiss Menu	
Minimise "Analyser - Picture"	
Close "Analyser - Picture"	

Figure 9-3: Analyzer - Picture Instrument Options Menu

The following table lists the standard options available in the Analyzer - Picture Instrument submenu:

Table 9-2 : Menu Options for the Analyzer - Picture Instrument

Item	Options	Description
Closed Captions	Disabled (Default)	The unit can detect closed captions carried in the ancillary data of a signal.
	OP47	Select this option to enable closed captions and display OP47 standard closed captions in the picture view. This displays an additional menu entry: OP47 Page.
	OP47 Page	Select the desired OP47 page containing the relevant closed captions, by using the slider or scrolling through page numbers in the range: 100 to 8ff.
	OP47 Show Unboxed	Select this option to enable the display of outside-of-box subtitles (closed captions) outside the permitted area for closed captions. When enabled, this menu item is displayed in yellow font to alert you that the subtitles are being displayed outside the usual display area. If you hover the cursor over this option, when enabled, you will see the following warning displayed: "Warning: OP47 unboxed captions are being shown, these characters should not be displayed by decoders when bit C6 (subtitle) is set." This option is disabled by default.
	608	Select this option to enable closed captions and display CEA 608 standard closed captions in the picture view for monitoring. This displays an additional menu entry enabling you to select the desired target field to contain the CEA 608 format closed captions. Note: 608 closed captions are not supported for SD-SDI, use the option 608 in 708 if you need to process 608 closed captions for analog TV.
	608 in 708	Select this option to enable closed captions and display 608 in 708 standard closed captions in the picture view for high definition (HD) video. This displays an additional menu entry enabling you to select the desired target field to contain the 708 format closed captions.
	608 Field	Select the desired field for the 608 captions, from either Field 1 or Field 2.
Picture Cursor	Disabled (Default)	When enabled, this feature is dynamically linked to both the Waveform and Dataview Analyzer instruments so that measurements from the selected picture position can be taken from these tools at the same time.
	Enabled	Allows you to select a specific line and pixel position in the picture. When you specify the line and pixel numbers, the unit positions a visible cross-hair at that position. You can change the location of the cross-hair by clicking at a different position in the Picture window. Line: Line one to Total number of Active Lines for the current standard. Pixel: Pixel zero to Total number of Active Pixels for the current standard minus one.
Ancillary Time Code (ATC) Display		

Item	Options	Description
Ancillary Time Code	Disabled (Default) Enabled	Activates the display of the ATC panel.
Ancillary Time Code Type	VITC (Default) LTC	When ATC enabled, choose whether to display the vertical interval (VITC) timecode or the linear timecode (LTC).
Ancillary Time Code Size	Small Medium Large Auto	Increases or decreases the displayed size of the ATC panel in the picture window. The Auto option adjusts the size of the timecode panel automatically, depending on the displayed size of the instrument window. When the instrument window is at 1/16 screen size, the Auto option sets the timecode panel to small, at 1/4 screen size to medium and at full screen to large.
Ancillary Time Code Position	Bottom Middle Top	Adjusts the displayed position of the ATC panel on the vertical center-line of the window.
Ancillary Time Code Field	Disabled (Default) Enabled	Activates an optional final digit in the furthest-right position of the time code to display a field identification flag for either 25 Hz or 24/30 Hz.
Safe Area Generation		
Action Safe Area	Disabled (Default) Enabled	Activates display of 16:9 safe area border for actions as a green, dashed border.
Graphics Safe Area	Disabled (Default) Enabled	Activates display of 16:9 safe area for graphics as a red, dashed border.
4x3 Safe Area	Disabled (Default) Enabled	Activates display of 4:3 safe area as a cyan, dotted border.
Custom Safe Area	Disabled (Default) Enabled	Activates display of a user-defined safe area as a white, dashed border.
Custom Height %	Enter percentage	Specifies the custom safe area height as a percentage of the full screen height, by adjusting the top and bottom screen margins.
Custom Width %	Enter percentage	Specifies the custom safe area width as a percentage of the full screen width, by adjusting the left and right screen margins.
Custom Height Offset %	Enter percentage	Specifies the custom safe area height offset as a percentage from the horizontal center line of the screen.
Custom Width Offset %	Enter percentage	Specifies the custom safe area width offset as a percentage from the from the vertical center line of the screen.
Crosshair	Disabled (Default) Enabled	Activates the display of a cross-hair to indicate the image center.
Message Center Display		
Message Center	Top Left Top Right Bottom Left Bottom Right	Defines the position of the Message Center panel in the Analyzer - Picture window by screen quadrant. The Message Center displays messages decapsulated from the ancillary data packets and includes SCTE 104 ID, AFD and V-Chip.

Item	Options	Description
Transparency	Disabled (Default) Enabled	Activates a transparent background to the Message Center in the Picture display.
Message Timeout (secs)	1 to 10 seconds	Defines the length of time in seconds dynamic SCTE104 messages are displayed in the Message Center. SCTE104 messages are removed from the Message Center after the timeout period.
AFD	Disabled (Default) Enabled	Activates the display of AFD markers in the Message Center of the Picture display.
Vchip	Disabled (Default) Enabled	Activates the display of V-chip markers in the Message Center of the Picture display.
ST309 Date	Disabled (Default) Enabled	Displays the date in ST 309 format: dd mmm yyyy . Once enabled, the date is displayed in the Message Center.
Analyzer Source	Disabled (Default) Enabled	Displays the selected source input to the Analyzer in the top-left corner of the Picture display. For example: Analyzer: 2110, Analyzer: 2022-6 etc.
SCTE104 Detection	Disabled (Default) Enabled	Activates the detection of SCTE104 packets in ancillary data and displays the message OpID, indicating the message type, in the selected Hex or decimal format.
SCTE 104 OpID Format	Decimal (Default) Hexadecimal	Defines whether to display the OpID of the SCTE104 message type in decimal or hex format.
Input Name	Disabled (Default) Enabled	Displays the defined source input name of the video stream, for example, the ID of the originating camera.
Input Name Configuration...	Opens Input Name Configuration Dialog Box.	Use the Input Name Configuration dialog to enter a source input name manually or to extract a name from the ancillary data.
On Video Loss (IP ST 2110 Mode)	Black Screen Freeze Last Frame	Choose what should be displayed in the Picture window in the event of video loss.

Using Closed Captions

Closed captions (or subtitles in Europe) are the text-based, encoded and hidden information included in the ancillary data of the video signal, which can optionally be displayed by the viewer. The unit can detect closed captions carried in the ancillary data and display them, when enabled, in the Analyzer - Picture Instrument for monitoring purposes.

The following closed caption formats are supported:

- **OP47** (or SMPTE RDD-08): European and Australian standard for closed captions/subtitles on HD TV. Supports the following languages: Czech, English, Finnish, French, German, Hungarian, Italian, Portuguese, Slovakian, Spanish and Swedish
- **608** and **608 in 708**: CEA-608 (or EIA-608) is a legacy US standard for closed captions. CEA-708 is the current US standard for closed captions on HD TV and is backward compatible with CEA-608. CEA-708 acts as a wrapper for embedded CEA-608 closed captions, enabling the unit to extract 608-standard closed captions from 708-standard ancillary data. Supports the following languages: Danish, English, Finnish, French, German, Italian, Portuguese, Spanish and Swedish.

Note: Legacy 608 (Line 21) closed captions are not supported for SD-SDI. Select the closed caption option **608 in 708** if you need to process analog TV 608 closed captions for SD-SDI video.

When configuring the **Analyzer - Picture** instrument to display closed captions, use the Ancillary Status and/or Ancillary Inspector instruments to establish which closed caption system is present in the video signal. The ANC Status display will show CEA-608, CEA-708 and OP47 data packets included in the vertical ancillary area of the SDI framework. You can then select the corresponding closed caption option from the Analyzer - Picture submenu.

To display closed captions in the Picture view, enable one of the **Closed Captions** options from the Analyzer - Picture menu and select the desired target page (OP47) or field (608 and 608-in-708) for the appropriate standard.

When enabled, closed caption/subtitle text is displayed in the Picture area as defined by the format of the selected closed caption standard.



Figure 9-4: Closed Captions in the Picture and Picture Copy Windows

The CEA-708 closed caption system (used in the USA and Canada for high definition (HD) video) embeds information in the VANC area of the HD-SDI video framework and uses data identifier (DID) 0x61 (Hex) for the Caption Distribution Packet (CDP). Typically this supports up to 6 different closed caption streams (or services).

The OP-47 closed caption system (used in Europe and Australia for HD-SDI) embeds closed caption text in the VANC area of the HD-SDI video framework using DID 0x43 (Hex). This system supports closed caption pages in the range 0x100 to 0x8FF (Hex).

Using Dual Picture Instruments

You can now open two instances of the **Analyzer - Picture** Instrument, where the second instance is a copy of the first. The same video signal is displayed in both windows and some features, if enabled, are common to both (see below).

When positioned alongside each other, you might use the dual Picture windows to monitor closed captions in different languages, or to compare different screen safe areas.

Open two Analyzer - Picture Instruments as follows:

1. Open the first **Analyzer - Picture** Instrument from the PHABRIX instrument launch menu.
2. Open the PHABRIX instrument launch menu again and select the option: **Analyzer - Picture Copy**.
3. You can now manage most overlay elements (excluding the ATC, OP-47 Page and optional HDR features, which are common to both windows) of the two Picture instruments independently using the submenu for each window.

Features common to both windows:

- Ancillary Time Code
- Position of Picture Cursor when enabled
- Closed Caption Standard
- OP-47 page
- All optional HDR functions, see the section [HDR Heat-map \(False Color Overlay\)](#).

Features that can be adjusted independently in both windows:

- Picture Safe Areas and Image Center Crosshairs
- Activation of Picture Cursor
- Field for 608 or 608-in-708 closed captions
- All Message Center features.

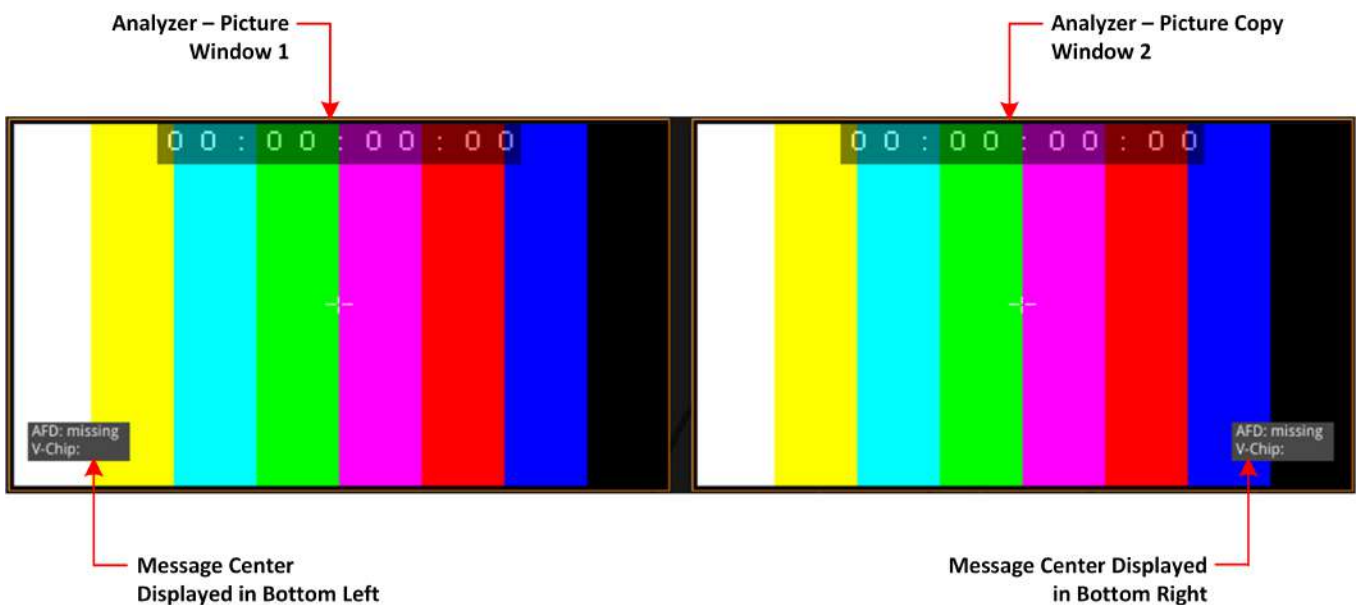

Figure 9-5: Two Picture Windows Displayed Side-by-side

Monitoring Closed Captions in Dual Picture Instrument Windows

If required, you can open a copy of the Analyzer - Picture instrument to have two Picture windows open at the same time. You can use this feature to monitor closed captions in a different language alongside the original language.

Select different language closed captions in dual Picture windows as follows:

1. In the first Picture window, select either of the closed caption standards: 608 or 608-in-708. This will also be automatically selected in the Picture Copy window.

- In the first Picture window, set the option **608 Field** to **Field 1**.
- In the Picture Copy window, set the option **608 Field** to **Field 2**.
The unit will now source the closed captions from the two different fields.



Figure 9-6: Dual Analyzer - Picture Instruments Showing Closed Caption Panel

When using either closed caption standard **608** or **608 in 708**, select a different field (Field 1 or Field 2) in each Picture Instrument to display a different language in the Picture Copy window.

Note: The OP-47 closed caption page, when selected, is linked between Picture windows so that the same page is displayed in both the Picture window and the Picture Copy window.

Picture Cursor

The Picture Cursor consists of two intersecting horizontal and vertical dashed lines. With the option **Picture Cursor** enabled, click anywhere inside the window boundary to position the intersection of the cursor. Alternatively, and more precisely, you can specify the exact line and pixel in position in the options menu. The **Line** value adjusts the vertical component of the Picture Cursor and the **Pixel** value adjusts the horizontal component.

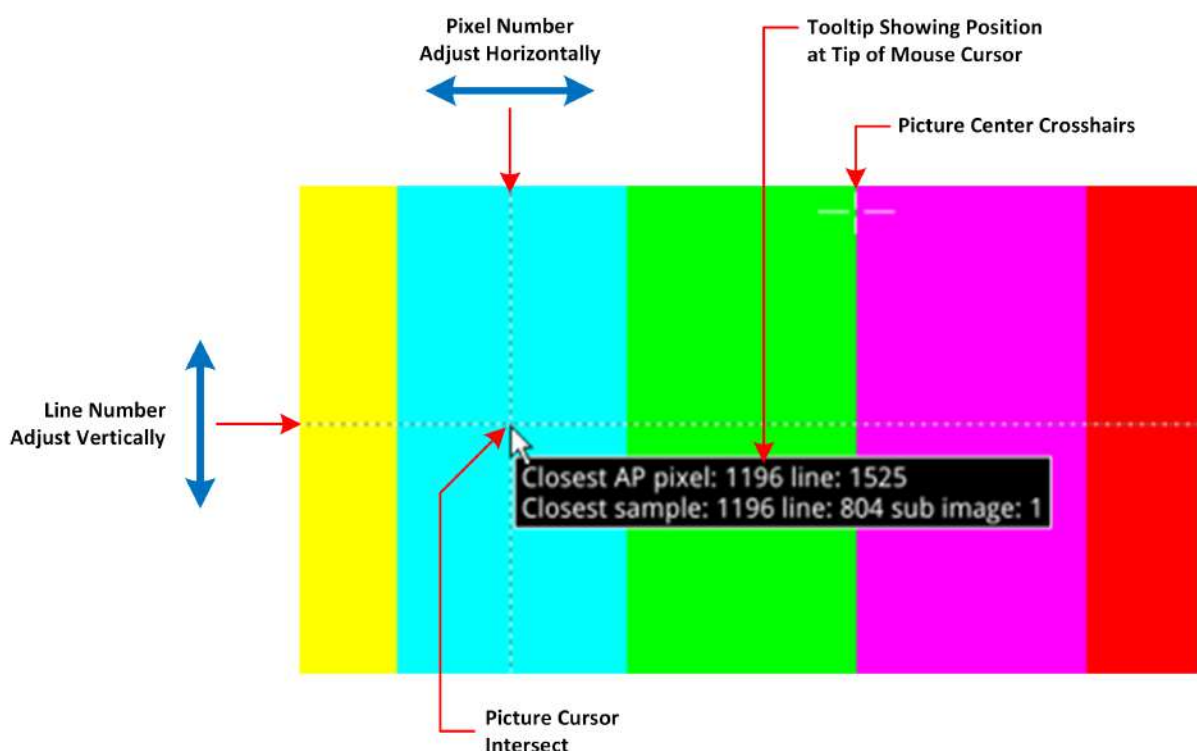

Figure 9-7: Two Picture Windows Displayed Side-by-side

If you hover the mouse cursor over the intersection of the Picture Cursor, the unit displays a tooltip showing the actual picture position by line and pixel. This feature is dynamically linked to both the Waveform and Dataview instruments so that measurements from the selected picture position can be taken from these tools at the same time.

Note: When using the Dataview Analyzer together with the Picture and Waveform Analyzer instruments, keep in mind that the Dataview includes horizontal blanking, and so uses transport line numbers, and not active picture line numbers.

Using the Picture Safe Areas

The **Analyzer - Picture** instrument features picture safe areas designed according to the EBU Recommendation R95 "*Safe Areas for 16:9 Television Production*".

Picture safe areas define the part of the picture that can be viewed without compromise on a TV or movie screen.

Note: This feature is not currently available for use with SD-SDI input signals in software version 5.2.

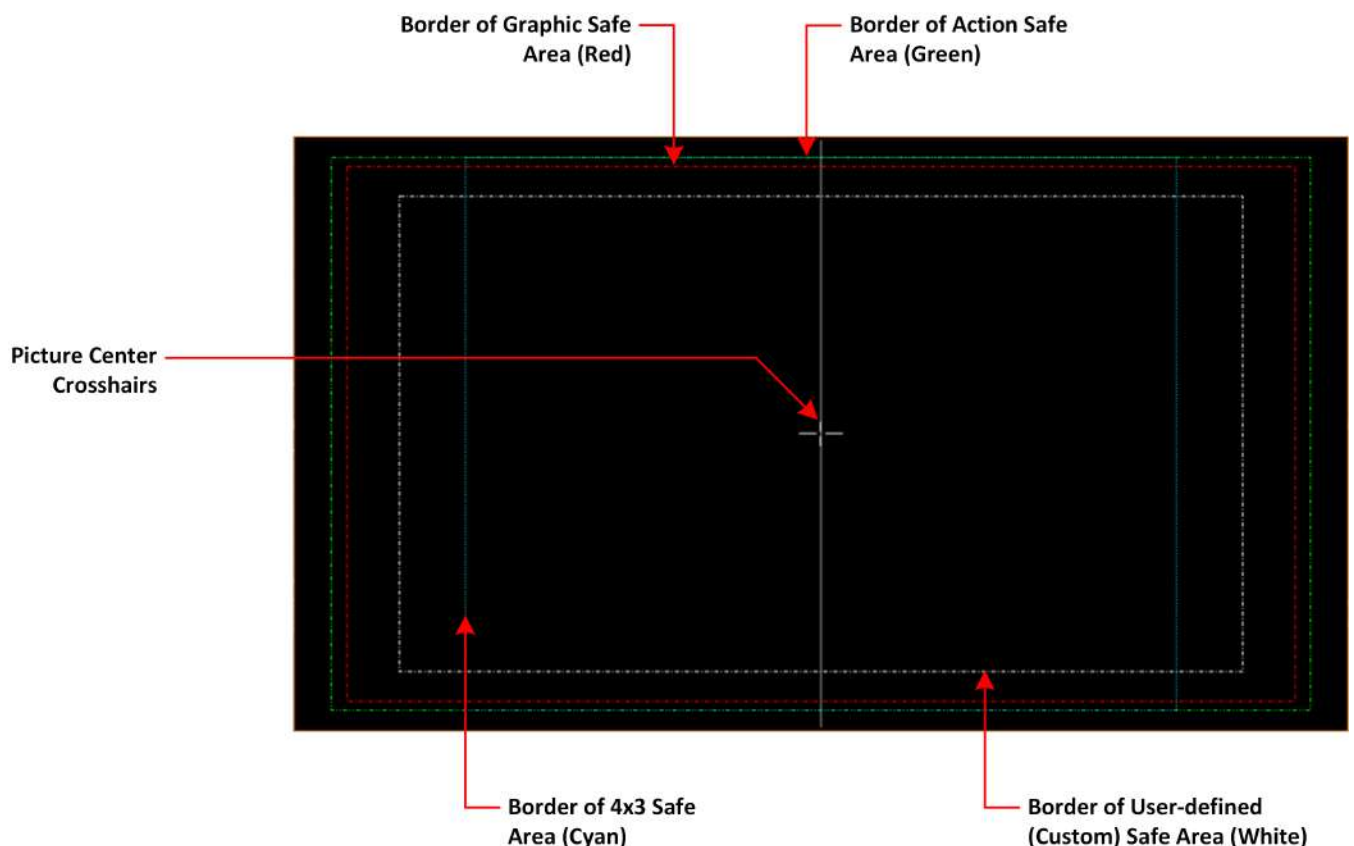

Figure 9-8: Picture Safe Areas Showing Border Colors

The Analyzer - Picture instrument can generate three predefined, independent safe areas for the following:

- **Graphics (16:9):** Smallest of the safe areas; ensures that all essential graphics are protected inside this area. The border of the Graphics safe area is 5% in from all edges of the screen.

- **Action (16:9):** Larger than the Graphics safe area; ensures that all essential program content is protected inside this area. The border of the Actions safe area is 3.5% in from all edges of the screen.
- **4x3:** Shows the safe area for HD video to be viewed on domestic TVs still using a 4:3 aspect ratio.

The Picture Instrument also includes a facility to generate a user-defined safe area, which enables you to set the height and width of the safe area or a vertical or horizontal offset from the top/bottom and left/right edges of the picture, respectively. Using this facility, you can define safe areas to comply with other international safe area standards.

In addition, when enabled, you can use the **crosshairs** function to display crosshairs marking the center-point of the picture.

The unit currently supports HD 16:9 formats, providing safe areas for 16:9 HD, 3G and UHD picture formats.

In combination with the dual Picture windows, you might use the safe areas feature, for example, to compare the safe area of an HD service with a simulation of either a second language HD service or an SD (4:3 or 16:9) version of the service. The SD 4:3 version may be created either by scaling the 16:9 image (linear or non-linear), cropping the 16:9 image, or a combination of both these methods.

For more information, see the EBU Recommendation R95 "*Safe Areas for 16:9 Television Production*."

Displaying the Picture Safe Areas

Activate a safe picture area in either of the Picture windows as follows:

1. Right-click in the Picture window to open the Instrument submenu.
2. To display one of the standard safe areas, simply select **Enabled** from the corresponding drop-down list. You can differentiate the safe areas by the color of their border, for example:
 - Action Safe Area - Green dashed-line border
 - Graphics Safe Area - Red dashed-line border
 - 4x3 Safe Area - Cyan dotted-line border
3. To display a custom safe area, set the **Custom Safe Area** to **Enabled**. This displays additional fields in which to specify the height and width of the custom safe area, using either:
 - An absolute percentage of the screen area for the safe area to occupy, or
 - A percentage offset from the horizontal and vertical edges of the picture.

Note: The user-defined custom safe area is displayed with a white dashed-line border

Using the Message Center

Note: For optional SD-SDI video input, the unit supports ancillary data as long as it is provided in ANC data packets according to SMPTE ST 291.

The **Message Center** is a designated area of the Analyzer - Picture instrument intended to alert you to the receipt of certain messages transported as packages in the ancillary data stream. The Message Center enables quality control of the source video material, both before and during transmission. On identifying one of the target message types, the Message Center decapsulates the message and displays an appropriate marker, text or ID to reference the message. You can configure the Message Center to display the following:

- **AFD Marker:** The Active Format Description is a set of codes used to identify the aspect ratio of the video signal and the protected areas of the picture.
- **V-chip Marker:** Identifies a parental guidance rating, used primarily in the US and Canada, to categorize age-sensitive material in a TV program. The V-chip hardware in the receiving television can be configured by the viewer to block certain categories of V-chip ratings as desired.
- **ST309 Date:** The date in ST 309 format: **dd mmm yyyy**
- **Analyzer Source:** Identifies the current, selected source input to the Analyzer. This can be **2110**, **2022-6**, or optionally **SDI**.
- **SCTE104 OpID:** The industry standard for including specific program signals and markers in the video signal at various timepoints, for example, program parts, commercial breaks, etc.
- **Input Name:** The defined source input name of the video stream

V-chip data is included with closed caption data of type CEA-608 or CEA-608-in-708. V-chip data is not currently available with closed captions of type OP-47. If 608 or 608-in-708 closed captions are enabled but unavailable and you then enable the V-chip marker, you will see that the V-chip label in the Picture submenu is displayed in yellow as a warning. Furthermore, if OP-47 closed captions are enabled, together with the V-chip marker, the V-chip label in the Picture submenu is displayed in yellow.

Note: For optional SD-SDI source video, V-chip data included with legacy 608 (Line 21) closed captions is not supported. Select the closed caption option **608 in 708** if you need to use V-chip for SD-SDI video.

The Message Center separates messages into either *static* or *dynamic* message types. When enabled, static messages are always displayed in the Message Center and indicate the Analyzer source input and the presence of a V-chip or Active Format Description (AFD) code in the ancillary data (when enabled).

Note: For optional SD-SDI source video, the unit supports AFD data as long as it is provided in ANC data packets according to SMPTE ST 2016-1 and ST 2016-3. Wide Screen signaling (WSS) and Video Index (VI) signaling (SMPTE RP 186) are not supported for SD-SDI.

Dynamic messages, however, are displayed for a configurable timeout period (in seconds) after which they are removed from the Message Center. The unit manages the OpIDs of SCTE104 packages, detected in the ancillary data, as dynamic messages. Each consecutive SCTE104 packet received by the unit replaces the previous displayed OpID.

For ease of viewing, you can choose the specific quadrant of the Analyzer - Picture window in which to display the Message Center from:

- Top-left quadrant
- Top-right quadrant
- Bottom-left quadrant
- Bottom-right quadrant.

Note: The Message Center is displayed only when you enable at least one of the message types (AFD, V-chip, ST309 Date, Analyzer Source, SCTE104 or Input Name) in the submenu.

The layout of the Message Center adapts so that it always displays the static messages closest to the picture edge, depending on the selected screen quadrant in which it is located. This ensures that the V-chip, Analyzer Source, and AFD codes are always displayed in the same position in the window.

Dynamic SCTE104 OpID codes are appended either above or below the static messages, again depending on the quadrant in which the Message Center is located.

The AFD packets in ancillary data are used to identify the aspect ratio of the video signal and key program indicators at various timepoints.

You can hover the mouse cursor over a SCTE104 OpID in the Message Center to display a tooltip containing the actual text of the message.

Note: V-chip, AFD ST309 Date, Analyzer Source, SCTE104 OpID and Input Name data packets will also appear in the **Analyzer - Ancillary Status** instrument (when enabled) and you can view the corresponding packet contents in the **Analyzer - Ancillary Inspector** instrument.

SCTE 104 Packet Detection

SCTE-104 is the broadcast industry standard for including specific program signals and markers in the video signal, for example, program parts, commercial breaks, etc.

When this option is enabled, the Analyzer - Picture window displays a list of SCTE-104 messages in the Message Center, with the most recent displayed at the top of the list. On receipt, the OpID code of each SCTE-104 message is displayed for at least two seconds, depending on the configured timeout period.

The unit displays the following information for each SCTE-104 message received:

- SCTE-104 operation ID (OpID) - identifies the SCTE104 message type.
- Message type as screen tip by hovering the mouse cursor over the OpID.

You can choose to display the message OpID in either hexadecimal or decimal format.

If you are interested in SCTE-104 messages, it is recommended to enable SCTE 104 messages in the Event Logger so that the full message type is saved to the logfile.

Defining Source Input Names

The unit provides a facility to enter identification strings for input sources, for example, cameras, etc. to identify the source of the input stream. The source ID is displayed in the Message Center for 5 seconds, with this 5 second timeout being reset each time the unit receives an Input Name ancillary packet. If the unit receives no further Input Name ancillary packets after 5 seconds, then it reports the Input Name as **Missing** in the Message Center.

You can choose either to enter the input name manually, or configure the Data Identifier (DID) and Secondary Data Identifier (SDID) value of the Input Name in the ancillary data of the input stream.

The Input Name is an ancillary data packet with the following message structure:

Ancillary Data Flag			DID	SDID	DC	Data	CS
0x000	0x3ff	0x3ff	0x53	0x49	nn	up to 12 ASCII chars	

Figure 9-9: Input Name Message Structure

In addition, you can define a prefix to be applied to the source input name, for example: **Input ID:**

Enter a source Input Name as follows:

1. Right-click in the Picture or Picture - Copy window to open the menu.
2. Select **Enabled** from the **Input Name** dropdown.
This displays the **Input Name Configuration...** button.
3. Click **Input Name Configuration...** to open the Input Name Configuration dialog.
4. Using a USB keyboard or over a VNC connection, configure an input name as follows:
 - a. If you require a standard prefix for your input names, enter the prefix text string into the **Prefix** field, for example **Source ID:**
 - b. To enter an input name manually, click the **User Entered** option button and enter the name using up to a maximum of 12 characters.
 - c. To extract an input name automatically from the ancillary data in the input feed, click the **Ancillary Data** option button and select the target DID and SDID. You can specify the DID/SDID using either decimal (default) or hex notation.
5. Click **OK** to save the input name.

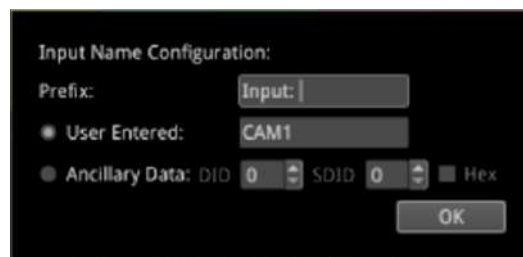

Figure 9-10: Input Name Configuration Dialog

Displaying the Ancillary Time Code (ATC)

Time and control code information, used to identify discrete video frames, is carried as the payload of packets located in the ancillary data space of the video signal. When you enable the ATC option in the Analyzer - Picture options menu, the ancillary time code is displayed in a panel overlaid across the Picture window.

Note: This feature is not currently available for use with SD-SDI input signals in software version 5.2.

The ATC is a 13 character time code with the following format:

ATC Format: (Integer Frame Rates)

hh : mm : ss : ff

ATC Format: (Non-integer Frame Rates)

hh : mm : ss ; ff

ATC Example:

00 : 00 : 00 : 00

ATC Example:

00 : 00 : 00 ; 00

Figure 9-11: Format and Example of the Ancillary Time Code

Where:

- Colon (:) Separator between seconds and frames indicates Integer frame rates
- Semi-colon (;) Separator between seconds and frames indicates drop-frame, non-integer frame rates (for example, 23.9, 29.9, 59.9, etc.)
- hh = hours (24 hour clock)
- mm = minutes
- ss = seconds
- ff = frame number

When enabled, the ATC panel is displayed in the top-center of the window by default and you can adjust both its position down the center line (top, middle or bottom) and the panel size (small, medium, large or automatic size adjustment) for ease of viewing.

The option **Anc Time Code Field** allows you to activate the display of an optional final digit in the time code, after the two digits of the frame number. If desired, you can use this digit as a field identification flag for either 25 Hz or 24/30 Hz.

When you enable the display of ancillary timecode information, the option **Anc Time Code Type**, allows you to choose whether to display the default ancillary time code - vertical interval timecode (ATC-VITC) or an ancillary time code - linear time code (ATC-LTC), if available.

On Video Loss (ST 2110 IP Input)

In the event of video loss, you can choose what should be displayed in the Picture instrument, if the video signal is lost, from either of the following options:

- Black Screen
- Freeze Last Frame



Overview

The **Waveform** instrument displays the selected input video signal as a waveform in a number of selectable waveform and display modes.

In addition, the Waveform instrument provides numerous analytical tools including:

- Various filters
- Single-line mode
- Picture cursor control linked to Picture and Dataview instruments
- Single-line mode link with Vectorscope instrument for Cb/Cr analysis
- Full-width display
- Highlight markers (including user-defined markers)
- Configurable horizontal (Y-axis) or vertical (X-axis) measurement cursors
- Powerful zoom and panning functions for detailed waveform inspection.

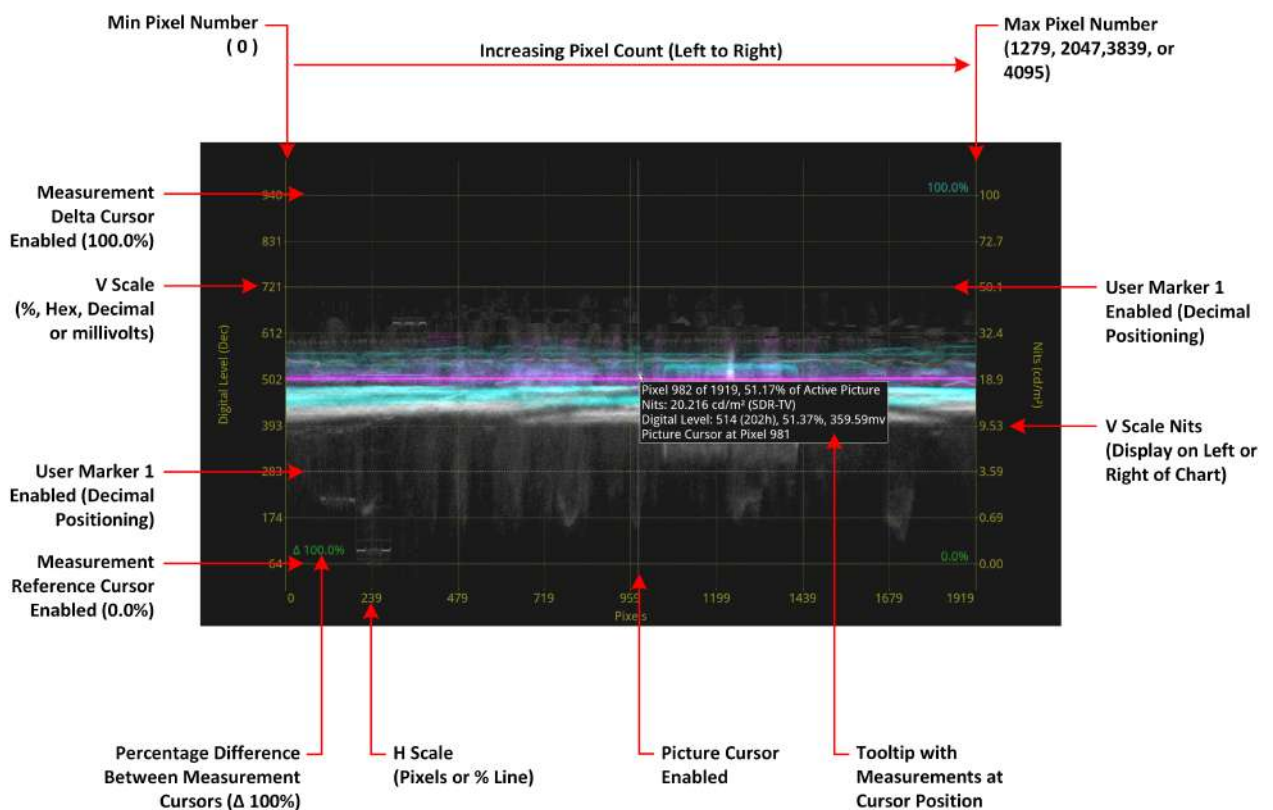

Figure 9-12: Analyzer - Waveform Instrument (Overlay Waveform Mode)

You can use the Waveform instrument in combination with the Picture / Picture - Copy, and Dataview instruments while displaying and adjusting Vectorscope user markers in the Waveform CbCr traces.

When the option **Picture Cursor** is enabled, the cursor is dynamically linked to the cursor in the Picture instrument and to Dataview navigation. Clicking the cursor in a new position in the Waveform window updates the pixel and active picture line position selected in the Picture instrument, and the pixel and transport line position selected in Dataview.

If you hover the mouse cursor over any point in the waveform display, you will see a tooltip displayed that provides the following information:

- Pixel x of the maximum number of active pixels and percentage of horizontal active picture
- Equivalent value in cd/m^2 (Nits) to the Digital Level on the Y axis
- Digital level in all other available but undisplayed units (decimal, Hex, percentage and mV)
- Pixel position of the Picture cursor
- Horizontal and vertical magnification factors when using the Zoom / Pan functions.

About the Display Modes

The waveform instrument can display up to four channels for analysis of the video signal color-space components in one of the following selectable display modes:

Note: Display Modes that include an Alpha channel are supported only for ST 2022-6 IP and optional SDI input.

- **YCbCr:** Luma (Y), Cb, and Cr components
- **YCbCrA:** Luma (Y), Cb, Cr and Alpha (A) components
- **Y:** Individual Luma component
- **Cb:** Individual Cb component
- **Cr:** Individual Cr component
- **RGB:** Red, Green, Blue components
- **GBR:** Green, Blue, Red components
- **YRGB:** Luma, Red, Green, and Blue components
- **YGBR:** Luma, Green Blue, Red components
- **RGBA:** Red, Green Blue, Alpha components
- **Red:** Individual Red component
- **Green:** Individual Green component
- **Blue:** Individual Blue component
- **Alpha:** Individual Alpha component
- **Custom:** Customize the display (see below).

When selected, the Waveform instrument displays the Alpha component of a waveform in white, that is, the same color as the Luma (Y) component and monochrome color mode.

Setting the Vertical and Horizontal Scales

You can choose to display various vertical scales at either the left- or right-hand side of the display and to set the horizontal scale to pixels or percentage of the video line.

[Figure 9-13](#) is a schematic representation of the horizontal and vertical scales available for use with the Waveform instrument in Overlay waveform mode with an SDR standard (2048 x 1080 p50 709 SDR YCbCr:422 10bit NR) and at full screen size. [Figure 9-14](#) shows the equivalent vertical scales available when analyzing the same standard (2048 x 1080 p50 709 SDR YCbCr:422 10bit FR) but at a full range bit depth.

For the Digital Level V scale (y axis), you can choose to measure in units of mV, decimal values, percentage or hexadecimal values. Similarly you can set the H scale (x axis) to either the number of pixels or as a percentage of the picture line.

Note: You can configure the waveform scale so that 100% Full Range is relative to either Protected Range (4 - 1019 in 10 bit) or Full Range (0 - 1023 in 10 bit).

By default the Waveform instrument displays the Nits scale on the right-hand side but you can choose to switch this to the left-hand side of the display. If you do so, the Digital Level scale switches to the right-hand side of the Waveforms display.

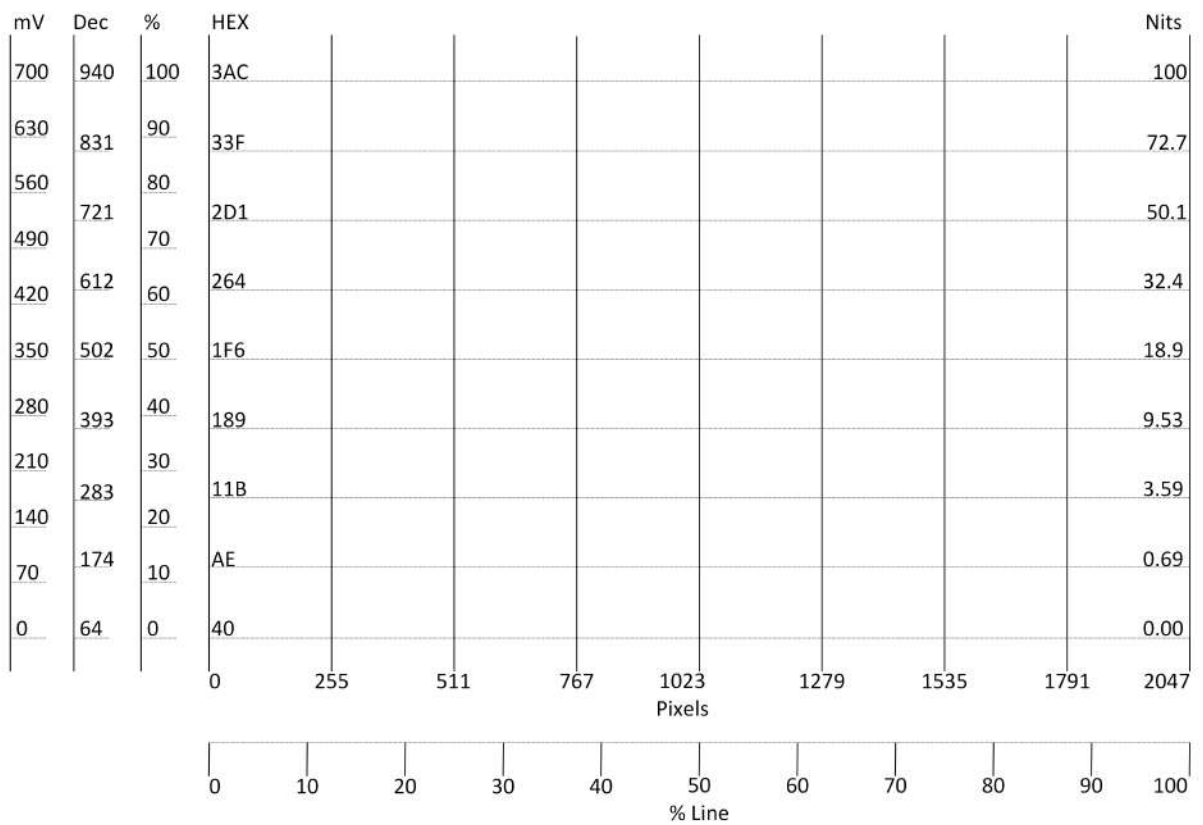

Figure 9-13: Schematic of Waveform Scales (Overlay Mode; SDR 2048 x 1080; Narrow Range, Full Screen Size)

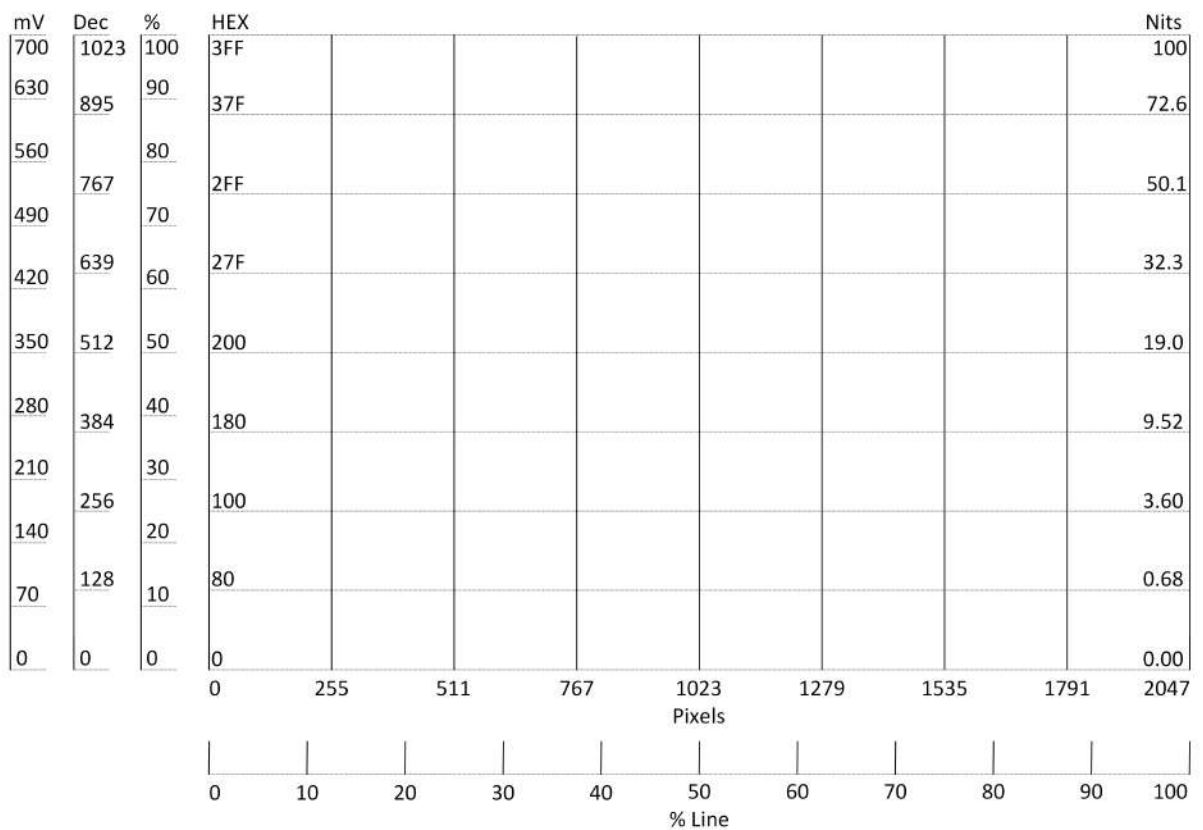

Figure 9-14: Schematic of Waveform Scales (Overlay Mode; SDR 2048 x 1080; Full Range, Full Screen Size)

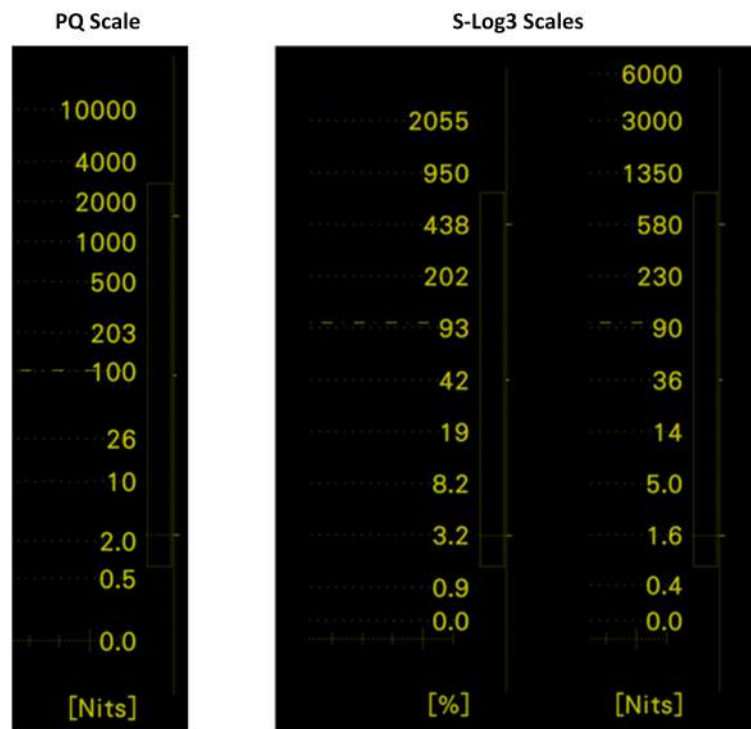

Figure 9-15: Comparison of PQ and S-Log3 Scales for HDR Waveform Analysis

Note: The Nits scale applies only to the luma (Y) component of the source input (if displayed) up to 100 cd/m². A Nits scale is not displayed for either of the Cb or Cr components if these are displayed either together or on their own.

Using Full-width Screen Mode

A full-width mode is available to display all waveforms in Stacked and Overview waveform modes or a single waveform in Parade mode. The unit displays the selected waveform or waveforms across the full width of the Waveforms display window. The vertical and horizontal scales remain visible but are superimposed over the waveforms.

Full-width mode enables you to align the overlay, stacked, or single channel parade waveform with the current video signal displayed in the Picture or Picture - Copy instrument as shown in [Figure 9-16](#).

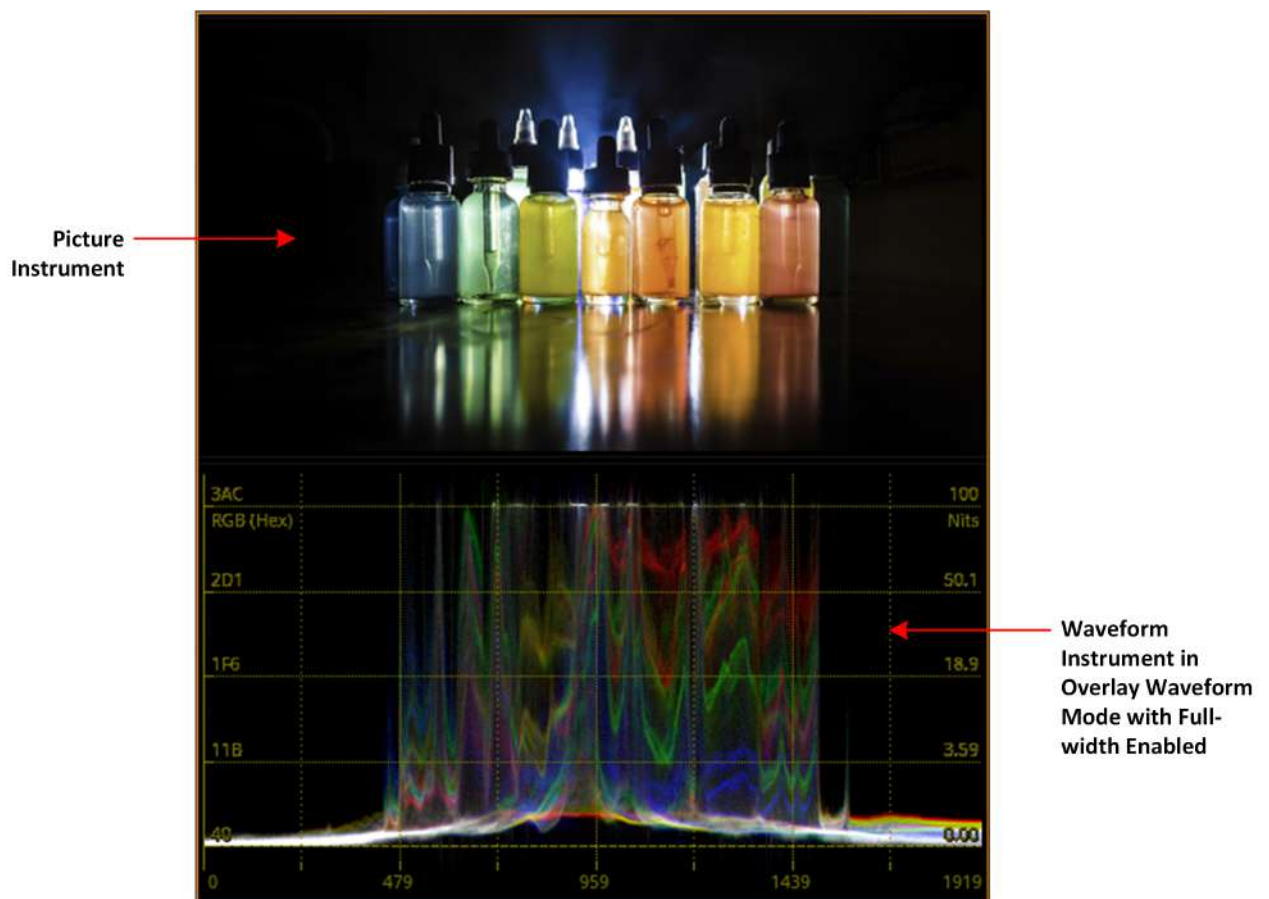

Figure 9-16: Waveform Instrument Matched to Width of Picture Instrument

Using the Custom Display Mode

In addition to using the standard display modes, you can use the Custom Display Mode Configuration option to define a non-standard layout for the Waveform instrument that may be more suited to a specific requirement.

To do so, open the **Custom Display Mode Config...** popup menu from the main Options menu. You can define the display mode for up to four channels by selecting a desired Display Mode from the **Channel 1** to **Channel 4** dropdown menus. The Channel 2, 3 and 4 dropdown menus become active only once you select a Display Mode for the previous channel.



Figure 9-17: Waveform Instrument Custom Display Mode Configuration Menu

To activate your defined custom display mode, select the **Custom** option from Display Mode dropdown menu.

About the Waveform Modes

[Figure 9-18](#) shows the source Picture and waveform analysis for each type of waveform mode in the display modes YCbCr and RGB.

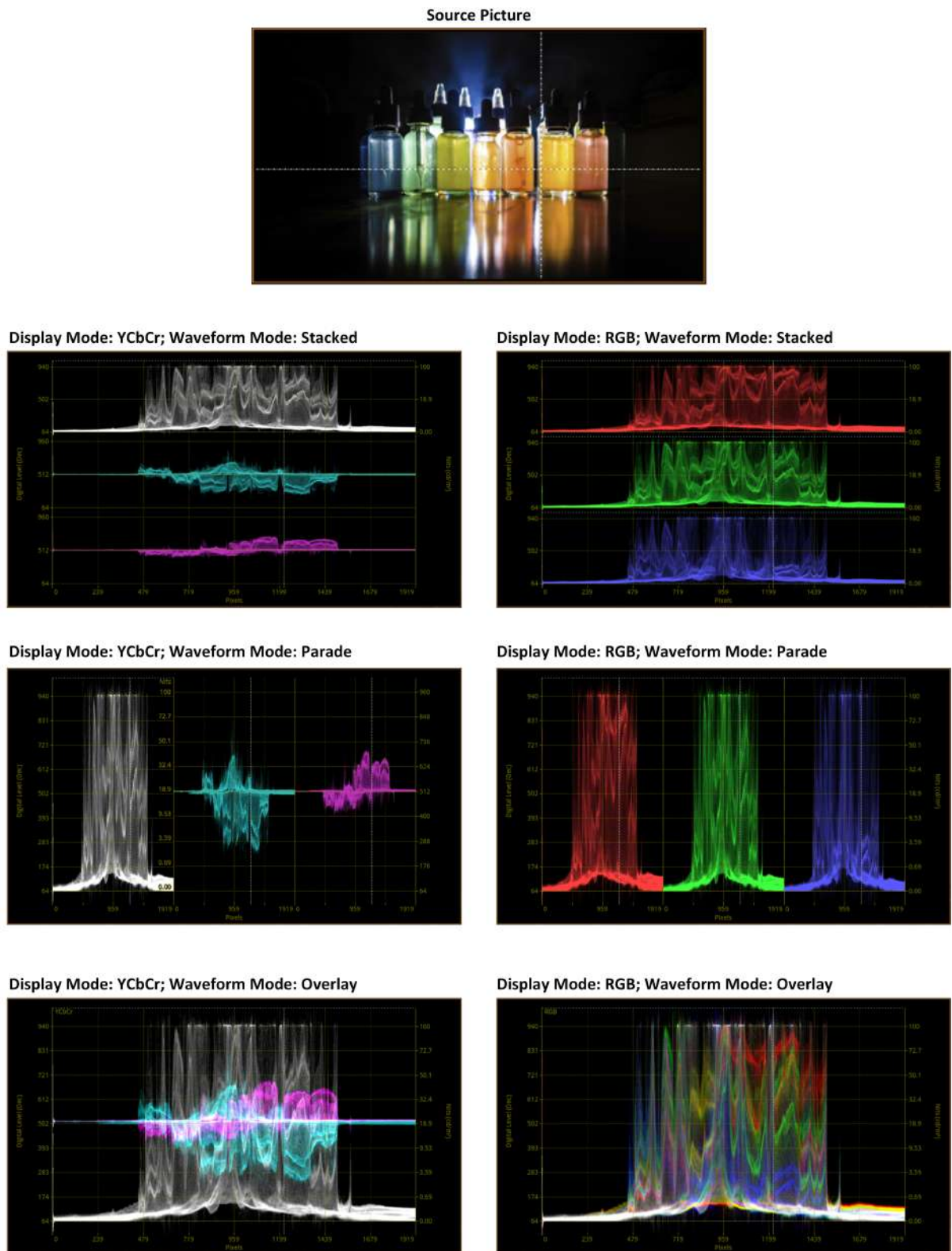

Figure 9-18: Waveform Instrument Waveform Modes for YCbCr and RGB Display Modes

For the waveform mode **Parade**, you can choose any of the following display modes which change the layout of the Waveform instrument as follows (see [Figure 9-19](#)):

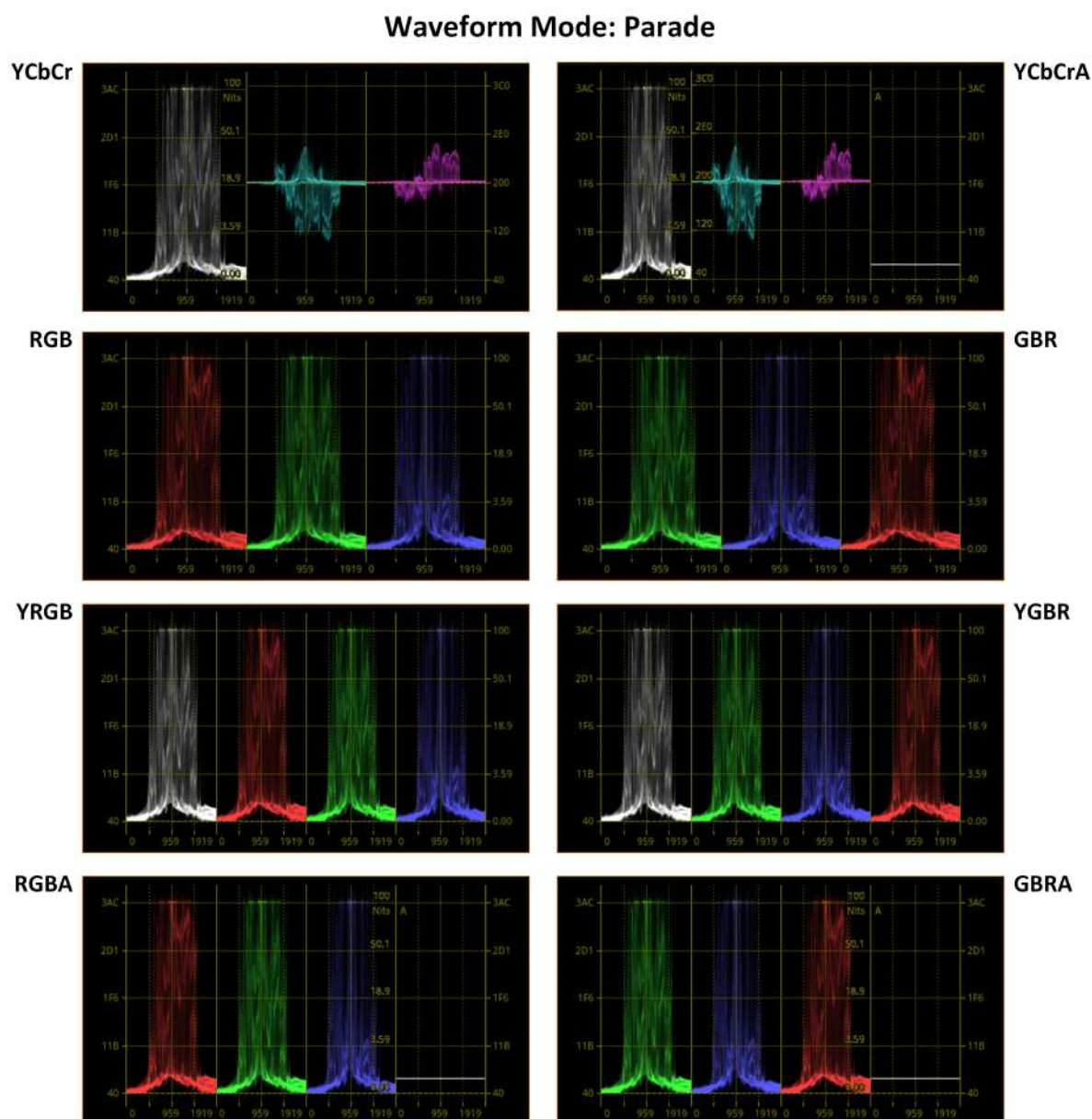

Figure 9-19: Parade Waveform Instrument Display Modes (Excludes Single Waveforms)

For the waveform mode **Stacked**, you can choose any of the following display modes which change the layout of the Waveform instrument as follows (see [Figure 9-20](#)):

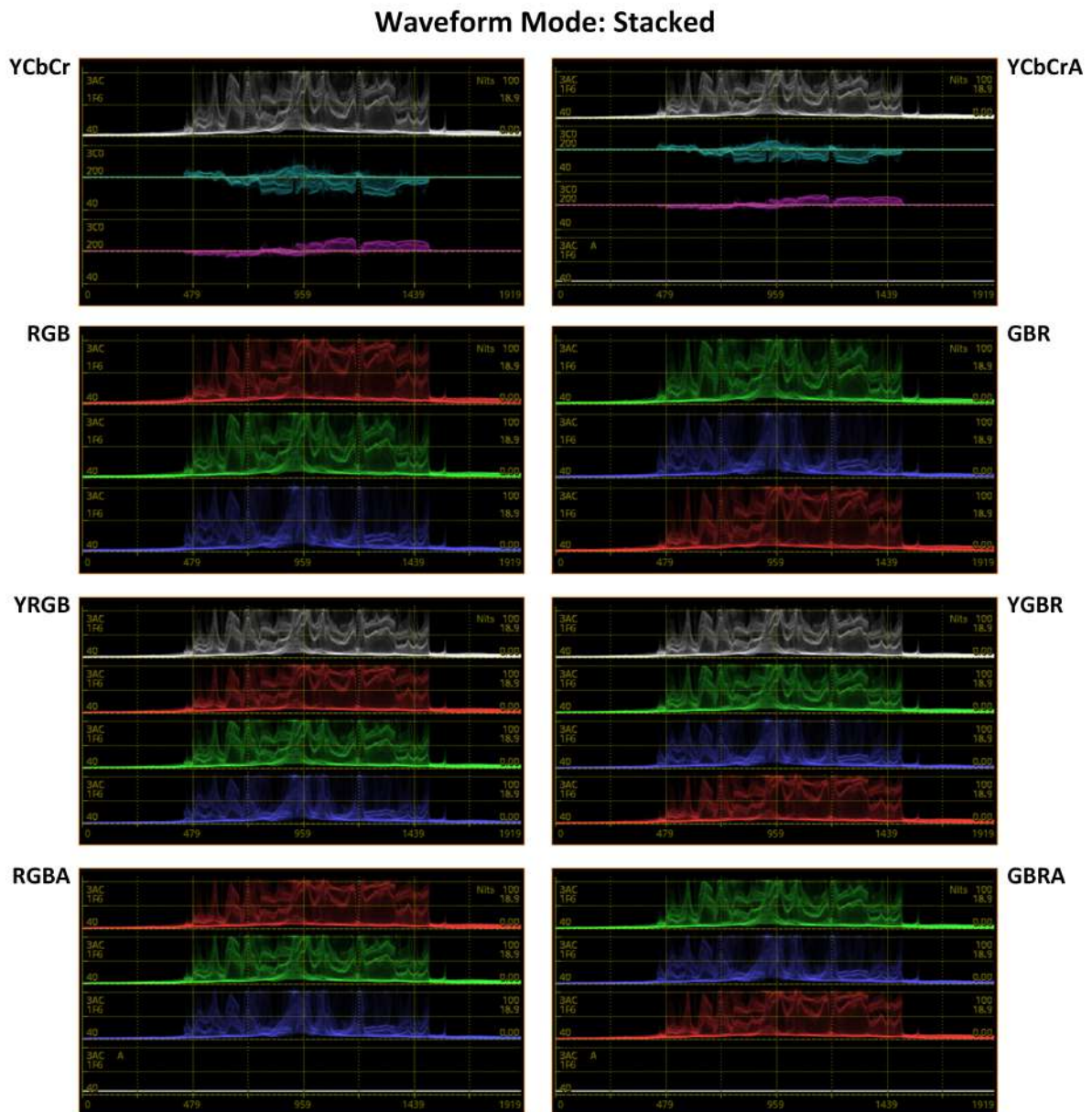

Figure 9-20: Stacked Waveform Instrument Display Modes (Excludes Single Waveforms)

As the waveform mode **Overlay** superimposes each component of the waveform on top of the other, the layout of the screen does not change in **Overlay** mode.

Using the Zoom and Panning Controls with the Mouse Scroll Wheel

The Waveform instrument provides powerful tools to zoom and pan the displayed waveform for more detailed investigation.

First use the H / V Magnification and H / V Position controls, with the options menu open, to locate an approximate area of interest within the displayed waveform.

Once you have done so, set the Zoom / Pan control to the type of zoom (both H and V axes, H axis only, or V axis only) or type of panning (H axis only or V axis only) required, then close the options menu. The Zoom / Pan control now sets the action of your mouse scroll wheel. When you scroll the mouse wheel, you will either magnify the waveform in the selected axis (or axes) or pan across the waveform vertically or horizontally, depending on your selection.

When zoomed-in on a waveform, hover the mouse cursor over any point in the waveform to display a tooltip containing both the standard level information, together with the horizontal and vertical magnification factors.

Using Picture and Dataview with the Waveform Instrument

When you enable the Picture Cursor in either the Analyzer - Picture or Analyzer - Waveform instruments (or both), the area of the picture around the cursor is highlighted in the Dataview instrument, as shown in [Figure 9-21](#).

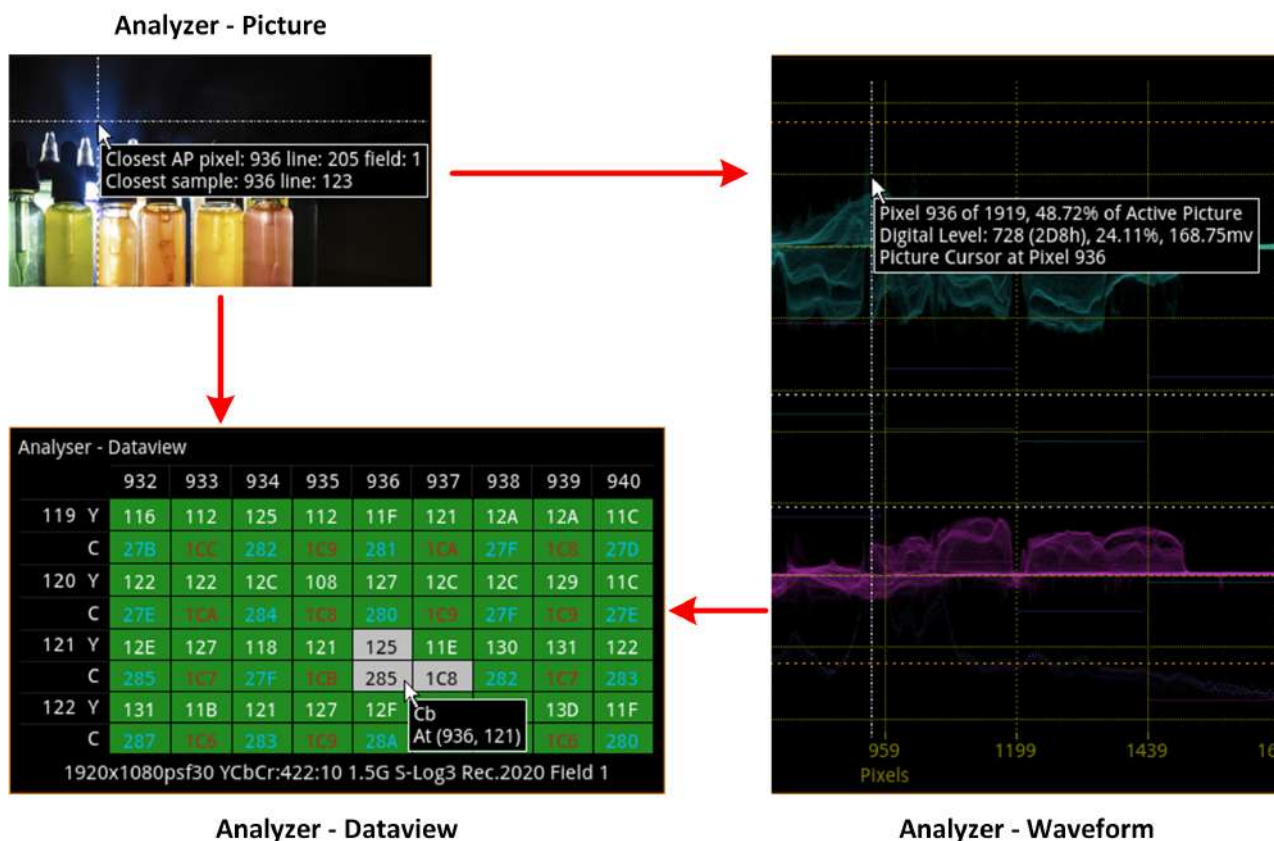
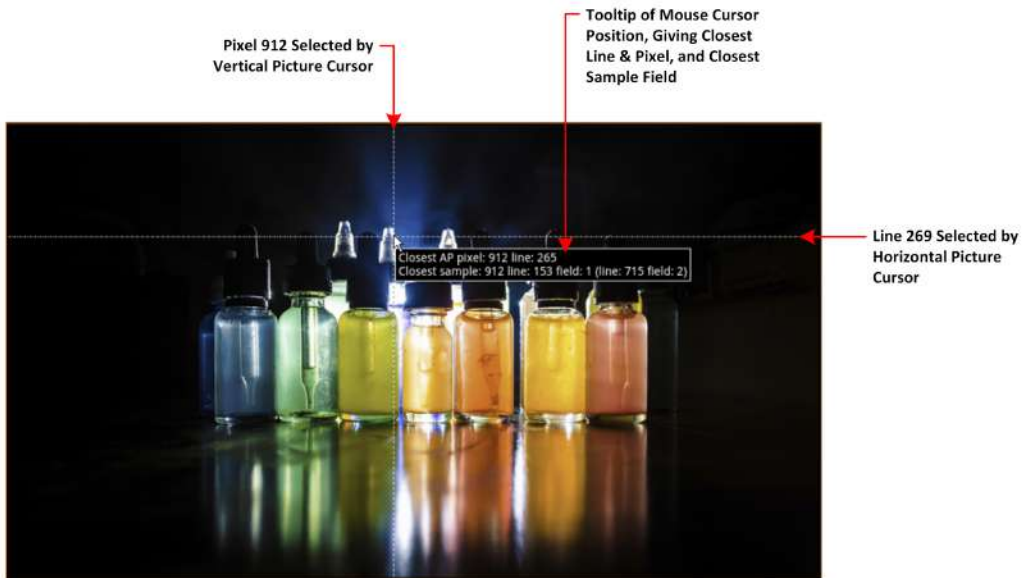

Figure 9-21: Interactive Linking of Picture Cursor in Picture, Waveforms, and Dataview

In addition, you can also use single-line mode without filtering (Raw) to identify datapoints without representational artifacts and perform detailed technical analysis of part of the source image, see [Figure 9-22](#).

Picture Instrument



Waveform Instrument Setup:

Display Mode: YRGB
Waveform Mode: Overlay
Full Width Mode: Enabled
Filter: Raw
Single Line Mode: Enabled
Line Number: 269
Picture Cursor: Enabled
Pixel Number: 912
H-Magnification: 10.00
V-Magnification: 4.00

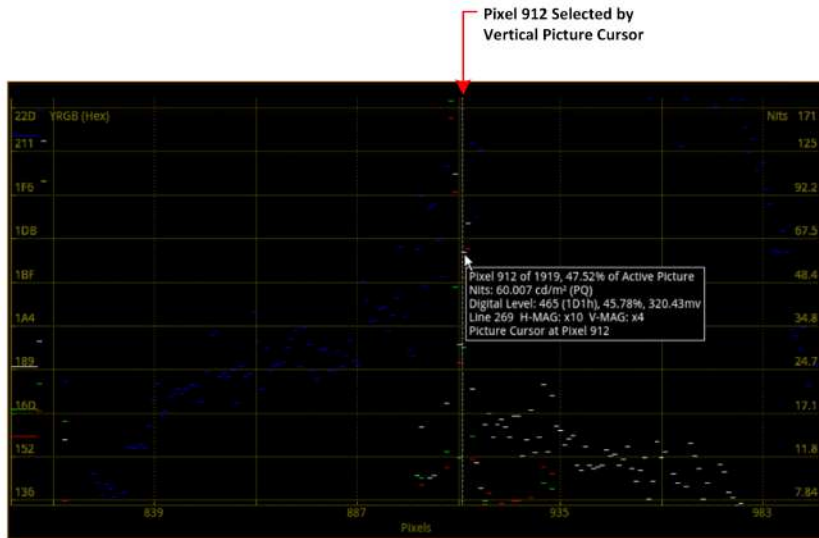

Waveform Instrument

Dataview Instrument

Analyser - Dataview

	903	904	905	906	907	908	909	910	911	912	913	914	915	916	917	918	919	920	921
link A 153 Y	1DE	215	268	2B9	2EB	362	3AA	3B0	3AF	3B0	39B	31C	1CA	149	17A	175	179	177	178
link A C	25A	25B	25C	25D	25E	25F	25G	25H	25I	25J	25K	25L	25M	25N	25O	25P	25Q	25R	25S
link B 153 Y	1E5	1FF	240	290	2D6	331	39A	3B0	3AF	3B0	392	33F	200	15D	177	16E	173	173	178
link B C	25A	25B	25C	25D	25E	25F	25G	25H	25I	25J	25K	25L	25M	25N	25O	25P	25Q	25R	25S
link A 154 Y	1DE	1FB	21B	25F	2CC	303	37E	3B0	3B0	3B0	398	351	21D	143	17F	176	179	178	175
link A C	25A	25B	25C	25D	25E	25F	25G	25H	25I	25J	25K	25L	25M	25N	25O	25P	25Q	25R	25S
link B 154 Y	1CC	1FA	1EF	22A	2B8	2EC	35B	3AE	3B0	3B0	39A	35B	246	160	16C	17B	185	185	169
link B C	25A	25B	25C	25D	25E	25F	25G	25H	25I	25J	25K	25L	25M	25N	25O	25P	25Q	25R	25S
link A 155 Y	1B7	1CE	1DF	22F	2B0	2E0	34A	3A5	3AF	3AF	3A0	373	26D	178	16B	170	174	170	17F
link A C	25A	25B	25C	25D	25E	25F	25G	25H	25I	25J	25K	25L	25M	25N	25O	25P	25Q	25R	25S
link B 155 Y	1B9	1D3	1C9	222	277	2B7	32C	394	3AF	3B0	3A8	377	28B	179	177	173	180	187	176
link B C	25A	25B	25C	25D	25E	25F	25G	25H	25I	25J	25K	25L	25M	25N	25O	25P	25Q	25R	25S
link A 156 Y	1C7	1C1	1CC	1F9	251	294	2EF	37D	3AE	3AE	3A0	373	26D	178	16B	170	174	170	17F
link A C	25A	25B	25C	25D	25E	25F	25G	25H	25I	25J	25K	25L	25M	25N	25O	25P	25Q	25R	25S
link B 156 Y	199	1C2	1DC	1ED	237	278	2CB	366	3AC	3AE	3A0	373	26D	178	16B	170	174	170	17F
link B C	25A	25B	25C	25D	25E	25F	25G	25H	25I	25J	25K	25L	25M	25N	25O	25P	25Q	25R	25S
link A 157 Y	1A0	19C	1B8	1EF	223	277	2CA	339	3A5	3AE	3A5	367	2CB	196	156	180	187	173	188
link A C	25A	25B	25C	25D	25E	25F	25G	25H	25I	25J	25K	25L	25M	25N	25O	25P	25Q	25R	25S
link B 157 Y	1B8	1B0	1B3	1CB	215	26F	2B2	32A	396	3A9	3A6	36A	2CD	1B3	152	189	17E	170	185
link B C	25A	25B	25C	25D	25E	25F	25G	25H	25I	25J	25K	25L	25M	25N	25O	25P	25Q	25R	25S

1920x1080p50 YCbCr:422:10 3G B PQ Rec.2020 Field 1

Hex Detail of Pixel Data at Pixels 912 & 913

Cb At (912, 155) Link B

Figure 9-22: Detailed Technical Analysis of Part of Image Using Waveform and Dataview Instruments

Using the Vectorscope with the Waveform Instrument

You can use the Vectorscope and Waveform instruments together, in combination, to analyze the Cb/Cr channels. If you enable single line mode in the Vectorscope it is automatically enabled in the Waveform instrument. Similarly, when the Cb and/or Cr channels are active, any adjustment of the User Markers in the Vectorscope is also reflected in the user markers of the Waveform instrument.

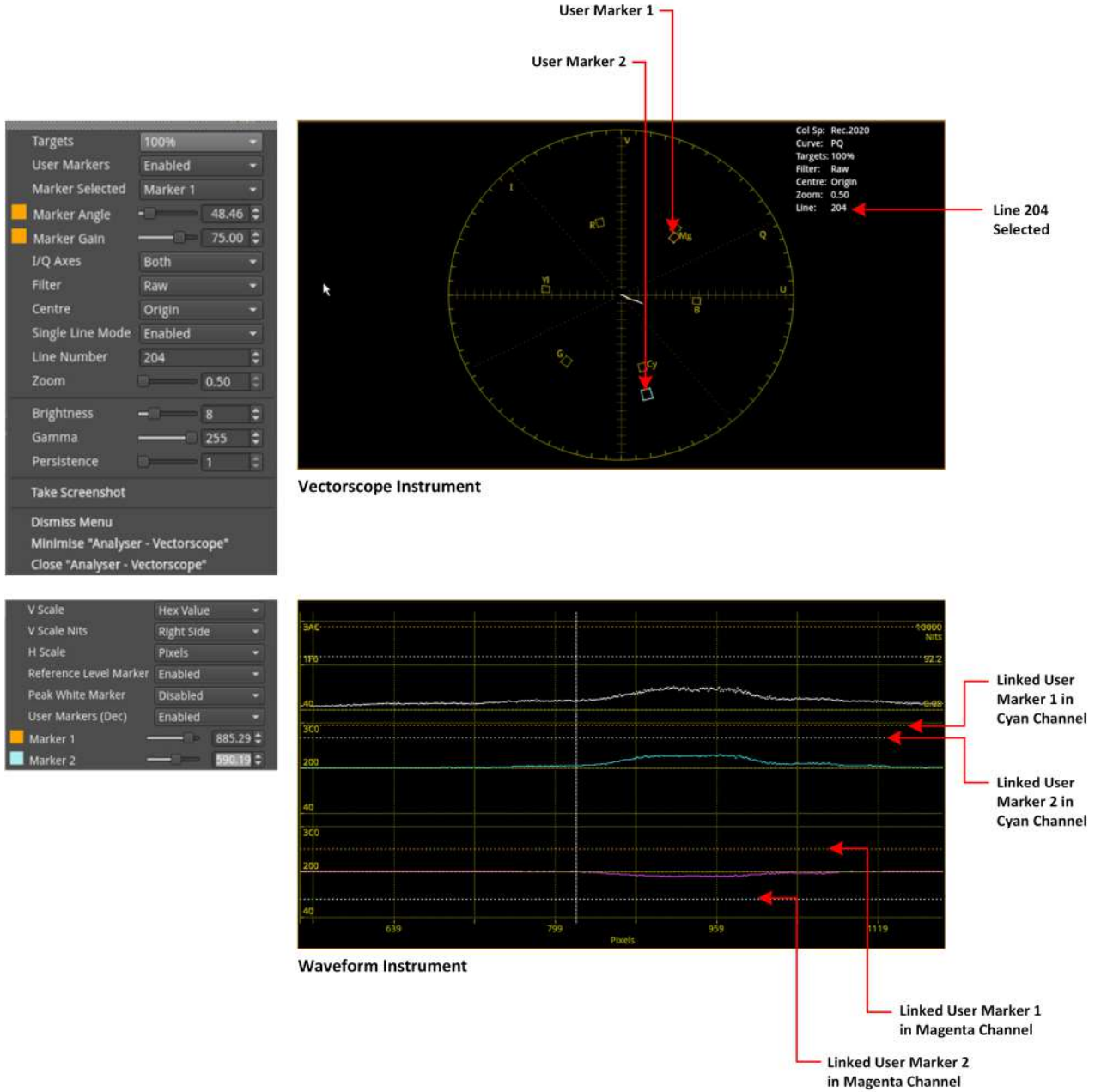

Figure 9-23: Interactive Linking of User Markers in Vectorscope and Waveform Instruments

Using the Waveform Measurement Cursors

The unit provides a pair of measurement cursors which you can configure to measure waveform values against either vertical or horizontal axes. When first enabled, the waveform measurement cursor(s) are displayed as one or two, horizontal dashed lines.

You can choose to display either a single measurement cursor or a pair of cursors. The cursor(s) are, by default, aligned horizontally to measure against the current Y axes (referred to as the **Y-axis Cursors**). You can, however, change the orientation of the cursor(s) so that they are aligned vertically to measure against the X axis (referred to as the **X-axis cursors**).

If you choose to display a single cursor, the cursor displays the measurement value at that point; there is no delta value. The single cursor is always referred to as the **Reference** (or REF) cursor.

If you choose to display both measurement cursors, the **Reference** cursor is displayed as a green dashed line (at **0%** by default) and the **Delta** cursor is displayed as a blue dashed line (at **100%** by default).

The value(s) measured by the cursor are displayed as follows:

- **For Y-axis cursors:** On the cursor, at the right-hand side of the display
- **For X-axis cursors:** Next to the cursor, at the top of the display.

When you enable both cursors, the difference (delta) between the values measured by the Delta and Reference cursors (Delta cursor value minus Reference cursor value) is displayed as follows:

- **For Y-axis cursors:** At the bottom, left-hand side of the display, above the Reference (green) cursor
- **For X-axis cursors:** At the bottom, left-hand side of the display, next to the Reference (green) cursor.

You can choose to position both waveform measurement cursors independently or linked together so that they move as a single unit, with a fixed value separation between them. In addition, the cursor (s) display the measured values, in the selected units, and update in real-time if their position changes.

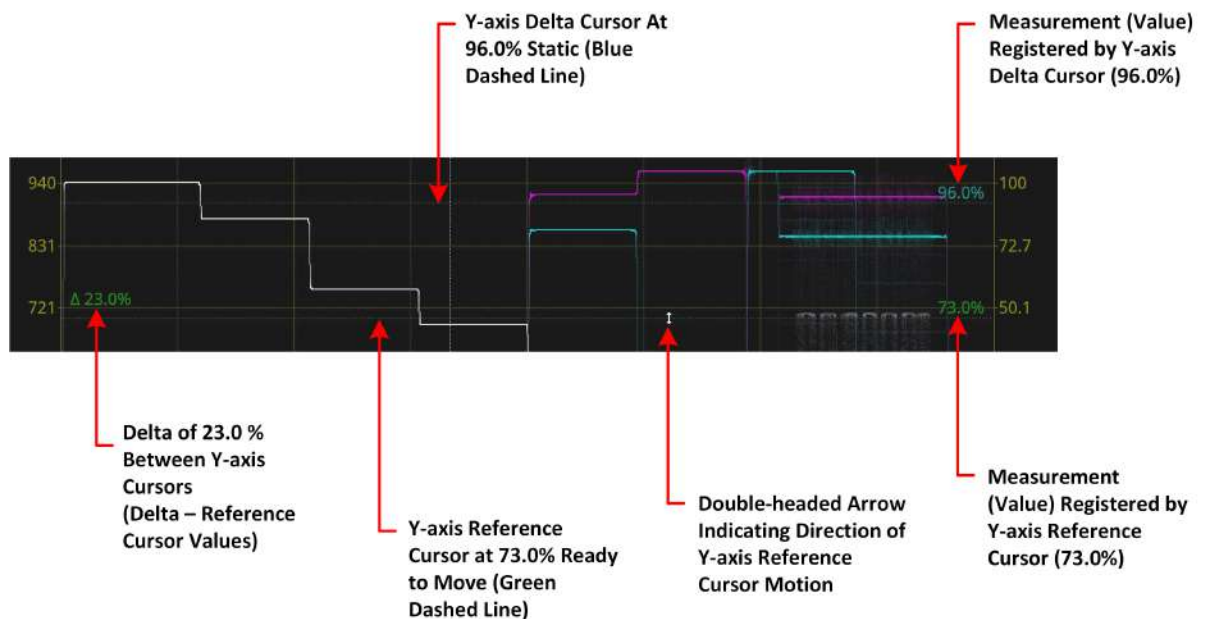

Figure 9-24: Waveform Measurement Y-axis Cursors (Independent Configuration)

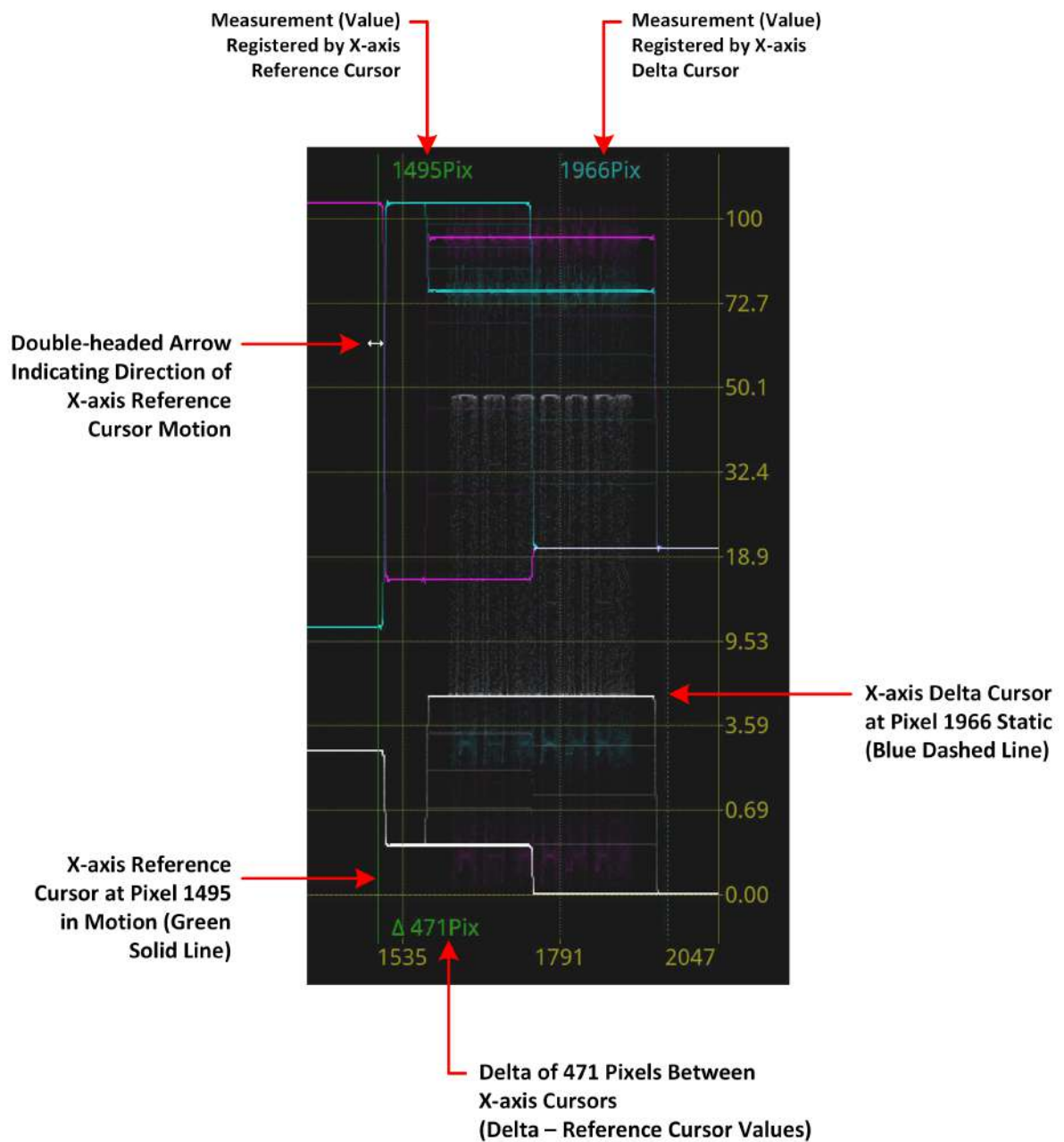

Figure 9-25: Waveform Measurement X-axis Cursors (Independent Configuration)

To position a measurement cursor, use one of the following methods:

- Open the options menu, then adjust the **Ref Cursor Position** slider to move the Reference cursor (recommended)
- Open the options menu, then adjust the **Delta Cursor Position** slider to move the Delta cursor (recommended)
- Select a cursor with a click and hold of the mouse pointer, (the selected cursor changes to a solid green or blue line). When you see a double-headed arrow, rotate the mouse scroll wheel forward or backward to move the cursor to a new position.
- Select a cursor with a click and hold of the mouse pointer, (the selected cursor changes to a solid green or blue line). When you see a double-headed arrow, move the mouse to drag the cursor to a new position.

Note: If both cursors are enabled and linked, then both will move together. To move a cursor independently when both are linked, adjust the **Cursor Differential** slider in the options menu. This action moves the Delta cursor while keeping the Reference cursor fixed in position.

When in motion, the dashed line of the cursor changes to a solid blue or green line for improved visibility. You will see the measured values on the cursors change in real-time as you adjust the cursor position(s).

You can configure the waveform measurement cursors to measure in different units, as follows:

- **For Y-cursors:** Select units of percent (default), percentage of reference, millivolts, hex value decimal value, or Nits.
- **For X-cursors:** Select units of percent (default), number of pixels, time (s) or frequency (kHz).

For information about the configurable parameters of the waveform measurement cursors, see the [Measurement Cursor Configuration](#) section of the options table.

Setting a % Reference

Setting the **% Reference** changes the reference value to the current Reference cursor position and the 100% delta cursor value to the current position of the Delta cursor.

Use the % Reference cursor scale to measure a position relative to a reference baseline that you set; otherwise, the measurement is relative to the 0 value of the waveforms display scale.

Note: Although it is recommended to set a reference when using the % Reference cursor scale, you can use this without setting a reference, however, this is the same as using the cursor scale Percent.

In the **Measurement Cursor Config...** submenu, first set the Cursor Scale to **Percent Ref**, adjust the position of the Reference cursor to the new baseline, then select **Set % Ref**. The Reference cursor value is displayed as **0.0%[REF]**. You can now adjust the measurement cursors to measure values within the new range.

On completion, select **Reset % Reference** to set the measurement cursors back to their default positions of 0 and 100%.

Starting Position with Delta Cursor (Blue) at 88.7% and Delta Cursor (Green) at 0.7%. Delta Between Cursors is 87.9%

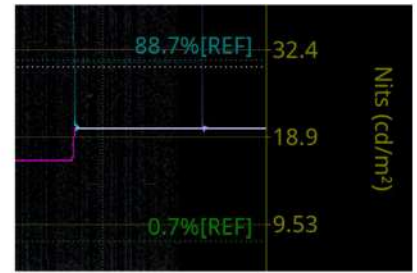

In Measurement Cursor Config... Submenu, select: Set % Reference

New Baseline (0.0%) Set at Reference Cursor Position and 100% at Delta Cursor Position



Change the Position of the Reference Cursor

New Delta of 100% Retained

On Completion, In Measurement Cursor Config... Submenu, select: Reset % Reference



Figure 9-26: Waveform Measurement Cursors - Using Set % Reference

Instrument Menu Options

The following table lists the configurable parameters in the Analyzer - Waveform instrument submenu:

Table 9-3 : Analyzer - Waveform Options

Item	Options	Description
Display Mode	YCbCr (Default) YCbCrA Y Cb Cr RGB GBR YRGB YGBR RGBA GBRA Red Green Blue Alpha Custom	Select the desired display mode in which to display the waveforms. For more information, see About the Display Modes .
Custom Display Mode Config...	System Control Opens the Custom Display Mode Channel configurations submenu.	See Custom Display Mode Configuration below for submenu parameters. For more information, see Using the Custom Display Mode .
Waveform Mode	Parade (Default) Stacked Overlay	Parade - displays each signal component individually in horizontally adjacent graphs, side-by-side. Stacked - displays each component in vertically adjacent graphs, one above the other. Overlay - displays each signal component from the same origin so that all components appear overlaid on top of each other, on the same graph.
Full Width Mode	Enabled Disabled (Default) Note: In Parade Waveform Mode, you can enable full-width mode for a single channel only.	When you select waveform modes Stacked, Overlay, or any single Display Mode (Red, Green, Cb, Cr, etc.) you can enable (or disable) full-width mode. This displays the waveform(s) across the full available width of the instrument, superimposing the H- and V-Scales over the waveform.
Scales & Markers Config...	System Control Opens the Scales & Markers configuration submenu.	See Scales & Markers Configuration below for submenu parameters.
Filter	Technical (Default) Production Low Pass Raw	Select the type of waveform filtering required. When you select the Raw option, no waveform is created; the dots displayed correspond to the pixel values recorded in the stream. There is no filtering applied to connect these pixels.

Item	Options	Description
Single Line Mode	Enabled (Default) Disabled	Enable a single line of the source video signal for detailed analysis.
Line Number	Numeric Field 1 to Maximum Line Number	When Single Line Mode enabled, select a specific line number, if required.
Picture Cursor	Disabled (Default) Enabled	When enabled, the picture cursor is dynamically linked to both the Picture and Dataview Analyzer instruments so that measurements from the selected picture position can be taken from these tools at the same time.
Pixel Number	Numeric Field 1 to Maximum Pixel Number	When Picture Cursor enabled, select a specific pixel number, if required.
Full Range Mode	RP.2077 (Default) SDI Protected	Uses full range, by default, as defined in SMPTE RP 2077 <i>Full-Range Image Mapping</i> but can be set to use full protected range, as required. For more information see the section Video Range Definitions for the Qx Series .
Measurement Cursors	Off (Default) Single Both	Enable either one (single) or two (both) measurement cursors. When displayed initially, the first, Reference cursor is displayed as a green dotted line located at the bottom of the waveforms display (0%). If you choose to display both cursors, the second Delta cursor is displayed as a blue dotted line at the top of the waveforms display (100%). The default setting is to display horizontal cursors, measuring against the Y axis. You can change the orientation of the measurement cursors in the Measurement Cursor Config... submenu.
Measurement Cursor Config...	System Control Opens the Measurement Cursor configuration submenu.	See Measurement Cursor Configuration below for submenu parameters. For more information see the section Using the Waveform Measurement Cursors .
Ref Cursor Position	Slider Control	Available for one or both measurement cursors. Moves the Reference cursor (green) to adjust the reference level.
Delta Cursor Position	Slider Control	Available when both measurement cursors are enabled and independent. Moves the Delta cursor (blue) to adjust the difference (delta) between the two cursors.
Cursor Differential	Slider Control	Available when both measurement cursors are enabled and linked. Moves the Delta cursor (blue) relative to the Reference cursor (green) while keeping the Delta cursor static.
Zoom / Pan	H & V Mag (Default) H Mag Only V Mag Only H Pos Only V Pos Only Sets zoom or panning	Note: The unit assigns your selected Zoom and Pan Control setting to the mouse scroll wheel, which becomes active once you close the Options menu. Select zoom magnification (Mag) for detailed inspection of waveforms. You can choose to zoom (magnify) either on both horizontal (H) and vertical (V) axes (H & V Mag) or

Item	Options	Description
	action of the mouse scroll wheel.	<p>restrict the zoom only to a single axis (H Mag Only or V Mag Only).</p> <p>In addition, you can select the panning modes (H Pos Only or V Pos Only) to scroll through the waveform either along the horizontal axis or vertical axis without zooming.</p> <p>When using Zoom / Pan, hovering the mouse cursor over any point of the waveform displays a tooltip that includes the H-Mag and V-Mag settings.</p> <p>The Zoom / Pan setting overrides the H / V Magnification and Position controls, described below.</p>
H Magnification	Slider control: 1.00 (Default) to 10.00	<p>Note: Use this control with the Options menu open to set an initial magnification level for the waveform. On closing the menu the Zoom / Pan control on the mouse scroll wheel takes precedence.</p> <p>Adjust the horizontal magnification of the waveform using the slider to locate an approximate position of interest in the waveform.</p> <p>When you increase the H magnification above 1.00, the H Position control becomes available to pan horizontally along the waveform while the Options menu is open. Once you close the Options menu the Zoom / Pan setting becomes active and you can zoom and/or pan using the mouse scroll wheel.</p> <p>Note: The Waveforms, Vectorscope, and CIE Chart instruments are all linked so that when you adjust the Horizontal Magnification in the Waveforms instrument it also adjusts the Horizontal Magnification in the other linked instruments, if they are active.</p>
H Position	Slider control Horizontal Axis	<p>Displayed when you adjust the Horizontal Magnification control above 1.00. Pans along the horizontal axis of the waveform.</p> <p>Enables you to adjust the focus of the waveform within the instrument window, along the horizontal axis, if the position of interest moves out of view when zooming.</p>
V Magnification	Slider control: 1.00 (Default) to 4.00	<p>Note: Use this control with the Options menu open to set an initial magnification level for the waveform. On closing the menu the Zoom / Pan control on the mouse scroll wheel takes precedence.</p> <p>Adjust the vertical magnification of the waveform using the slider to locate an approximate position of interest in the waveform.</p> <p>When you increase the V magnification above 1.00, the V Position control becomes available to pan vertically through the waveform while the Options menu is open.</p>

Item	Options	Description
		Once you close the Options menu the Zoom / Pan setting becomes active and you can zoom and/or pan using the mouse scroll wheel.
V Position	Slider control Vertical Axis	Displayed when you adjust the Vertical Magnification control above 1.00. Pans along the vertical axis of the waveform. Enables you to adjust the focus of the waveform within the instrument window, along the vertical axis, if the position of interest moves out of view when zooming.
On Video Loss	Black Screen (Default) Freeze Last Frame	(ST 2110 IP input only) Select what to display in the Waveform window in the event of losing the video signal.
Brightness	Slider control: 1 to 255 (Default: 255)	Adjust the brightness of the waveform display.
Gamma	Slider control: 0.2 to 1.00 (Default: 0.5)	Adjust the gamma component of the waveform display.
Persistence	Slider control: 0 to 511 (Default: 255)	Adjust the persistence of the waveform display.
Advanced...	System Control	Enables you to adjust the gain on any of the four channels independently. See Advanced Waveform Controls below.
Restore Default Levels	System Control	Reset the Waveform instrument to its default levels.
Color Mode	Color (Default) Highlight Green Monochrome	Select the desired display color for the waveforms, from the four distinct color modes. Highlight is a combination of color with monochrome highlights. This color mode uses a logarithmic algorithm to amplify the displayed intensity of each color, using monochrome (white).
S-Log3 Mode	S-Log3 (Default) SR Live	For HDR video signals, see the section Advanced HDR Toolset . Use when analyzing an S-Log3 or S-Log3 Live signal. Set to SR Live, to extend the range of the Nits scale.
Custom Display Mode Configuration		
Channel 1	Y Cb (Default) Cr Red Blue Green Alpha	Select any of the available single Display Modes to display in the Channel 1 position.
Channel 2	None Y Cb Cr (Default) Red Blue Green Alpha	Select any of the available single Display Modes to display in the Channel 2 position.
Channel 3	None (Default) Y	Select any of the available single Display Modes to display in the Channel 3 position.

Item	Options	Description
	Cb Cr Red Blue Green Alpha	
Channel 4	Disabled (Default) None Y Cb Cr Red Blue Green Alpha	Enabled only when you select a parameter for Channel 3. Select any of the available single Display Modes to display in the Channel 4 position.
Scales & Markers Configuration		
V Scale	Percent Hex Value (Default) Decimal Value Millivolts	Select the units for the vertical (Y-axis) scale in the instrument window.
V Scale Nits	Hidden Right Side (Default 1/4 screen size) Left Side	Select the position of the vertical (Y-axis) Nits scale. By default, the Nits scale is positioned on the right-most Y, R, G or B channel. Without any of these channels, no NITS scale is displayed. If the right-most channel is Cr or Cb, the NITS scale is displayed (by default) to the right of the first non-Cb/-Cr channel found when moving to the left.
H Scale	Pixels (Default) % Line	Select the units for the horizontal (X-axis) scale in the instrument window.
Reference Level Marker	Disabled (Default) Enabled	Enable a reference level marker across all waveforms in HDR standards at a fixed value of 203 cd/m ² (nits). When enabled, the marker is set at 58% for Perceptual Quantizer (PQ) and 75% for Hybrid Log-Gamma (HLG) functions, see Figure 9-28 .
Peak White Marker	Disabled (Default) 1000 Nits 2000 Nits 4000 Nits 10000 Nits	Enable a peak white marker across all waveforms in HDR standards at a selectable level in Nits.
User Markers (Dec)	Disabled (Default) Enabled	When enabled, this feature allows you to position user markers anywhere in the waveform display. Provides two color-coded sliders for Marker 1 and Marker 2, which you can adjust along the V Scale (Y-axis).
Marker 1 and Marker 2	Slider Controls	When user markers are enabled, adjust from the minimum to maximum value of the selected V Scale. For example, if set to Hex or Decimal Value, the maximum value will vary with bit depth.
Measurement Cursor Configuration		
Cursor X/Y Select	Y (Default) X	Select either horizontal Y-axis cursor(s) or vertical X-axis

Item	Options	Description
		cursors to measure against the Y-axis or X-axis, respectively.
Cursor Scale (For Y-axis Cursor(s))	Percent (Default)	Select the required scale for the Y-axis cursor measurements. Measurement values are displayed as a percentage of the default reference (0%).
	Percent Ref	Measurement values displayed as a percentage of the reference value at the point you selected Set % Reference , or the default reference (0%) if no user-defined reference is set.
	Millivolts	Measurement value displayed in millivolts
	Hex Value	Measurement value displayed in hexadecimal with 0 to 100% expressed as 040 to 3AC (YRGB) or 3C0 (CbCr). (Values for SDR input only.)
	Decimal Value	Measurement value displayed in hexadecimal with 0 to 100% expressed as 64 to 940 (YRGB) or 64 to 960 (CbCr). (Values for SDR input only.)
	Nits	Measurement value displayed in Nits (cd/m ²)
Cursor Scale (For X-axis Cursor(s))	Percent (Default)	Select the required scale for the X-axis cursor measurements. Measurement values displayed as a percentage of the picture width.
	Pixel	Measurement value displayed in number of pixels.
	Time	Measurement value displayed in seconds.
	Frequency (kHz)	Measurement value of frequency displayed in units of kHz. The length of one period is set to the separation between the two cursors.
Cursor Values	Displayed (Default) Hidden	Choose whether to display the values measured at the current cursor position and the difference between the values when both cursors are active.
Cursor Adjustment	Independent (Default) Linked	When both cursors are active, you can choose whether you want to move each cursor independently of the other or to link both cursors. When linked, both cursors move together as a unit, maintaining a fixed separation between them.
Set % Reference	System control	Set a new reference range between the current positions of the Reference and Delta cursors, equal to the range 0 to 100%. See Figure 9-26
Reset % Reference	System control	Returns the measurement range to the defaults: For Y-axis Cursors: Percent Scale: 0 to 100% Decimal Scale: 64 to 940 (YRGB) or 64/960 (Cb/Cr) (SDR input) Hex Scale: 40 to 3AC (SDR input) Millivolt Scale: 0 to 700 mV For X-axis Cursors: Pixels: 0 to maximum pixel number for standard % Line: 0 to 100%

Item	Options	Description
		Both cursors also return to their original default positions at top or right (100%) and bottom or left (0%) of the waveform display.
Advanced Waveform Controls		
Channel 1 Gain	Slider control; 0 to 1.9 1.00 (Default)	Adjust the gain setting for the Channel 1 waveform. The gain setting enables you to adjust the brightness of the trace displayed in Channel 1, changing its apparent brightness independently of the components in the other channels.
Channel 2 Gain	Slider control; 0 to 1.9 1.00 (Default)	Adjust the gain setting for the Channel 2 waveform. The gain setting enables you to adjust the brightness of the trace displayed in Channel 2, changing its apparent brightness independently of the components in the other channels.
Channel 3 Gain	Slider control; 0 to 1.9 1.00 (Default)	Adjust the gain setting for the Channel 3 waveform. The gain setting enables you to adjust the brightness of the trace displayed in Channel 3, changing its apparent brightness independently of the components in the other channels.
Channel 4 Gain	Slider control; 0 to 1.9 1.00 (Default)	Adjust the gain setting for the Channel 4 waveform. The gain setting enables you to adjust the brightness of the trace displayed in Channel 4, changing its apparent brightness independently of the components in the other channels.

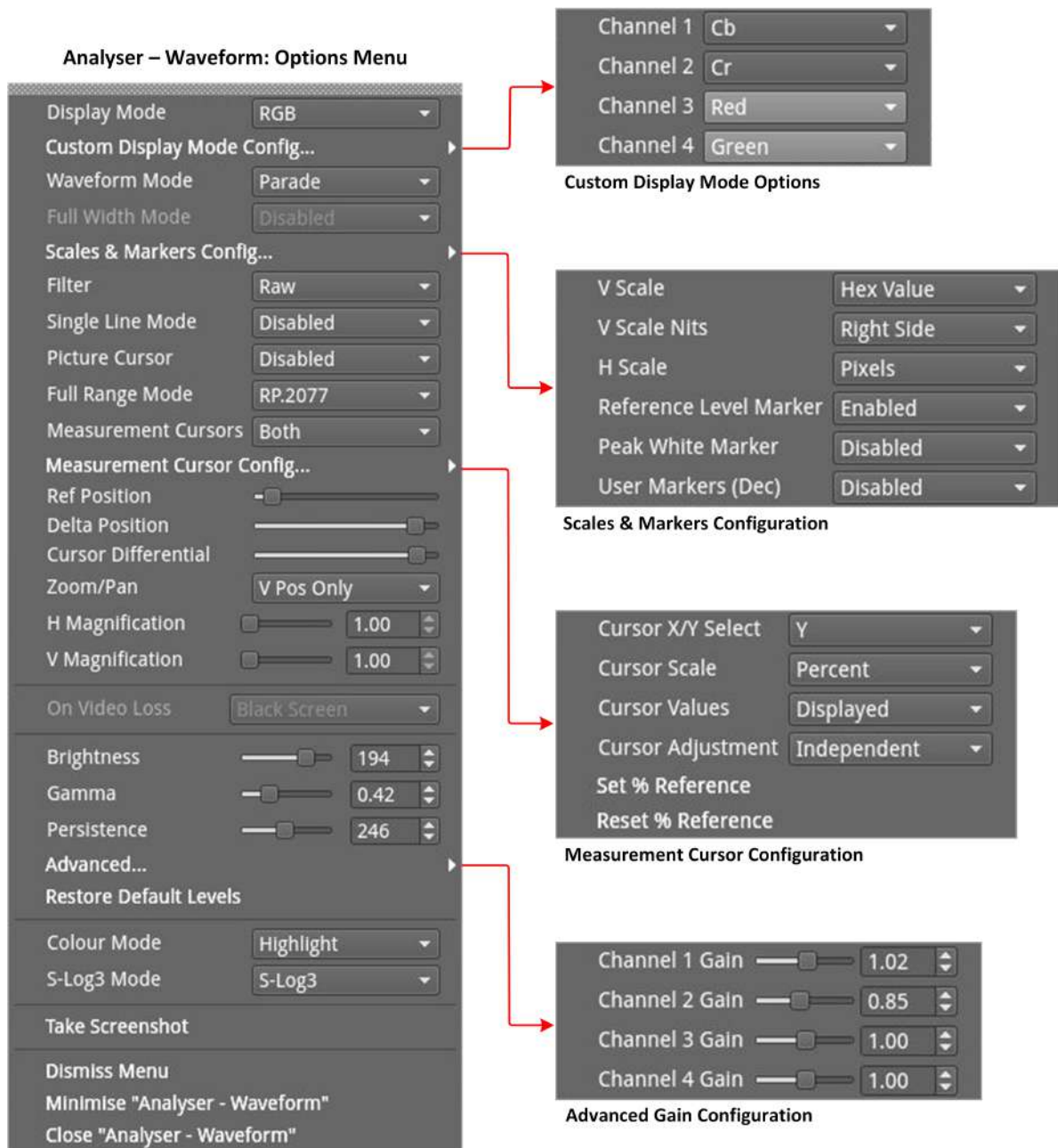

Figure 9-27: Analyzer - Waveform Options Menu and Submenus

The following figure shows the difference between the **Reference Level Markers** used with HDR PQ 2020 and HDR HLG 2020 when selected from the **Scales & Markers Config...** submenu.

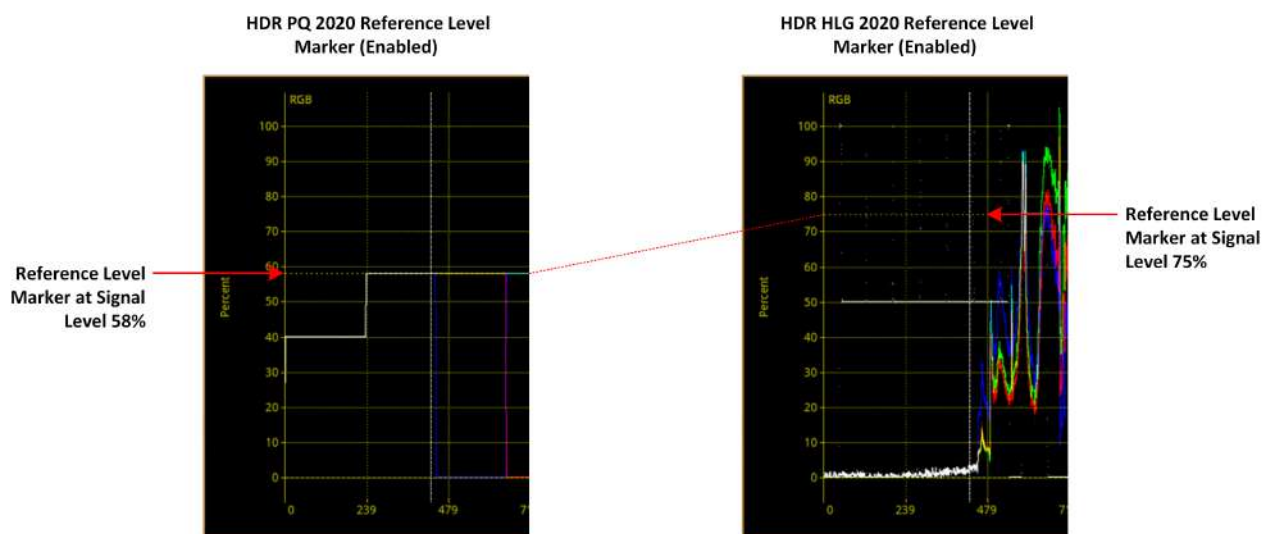

Figure 9-28: Analyzer - Waveform Options Menu - Reference Level Marker (HDR Only)



Overview

The Vectorscope is part of the video core toolset that provides a polar (X-Y) display of the Cb and Cr Color Difference representations of the image, where the hue of the color is the angular component of the polar display. The Y component of the YCbCr video input to vectorscope is ignored. The vectorscope presents the amplitude of the color difference signal as the distance from the origin (black).

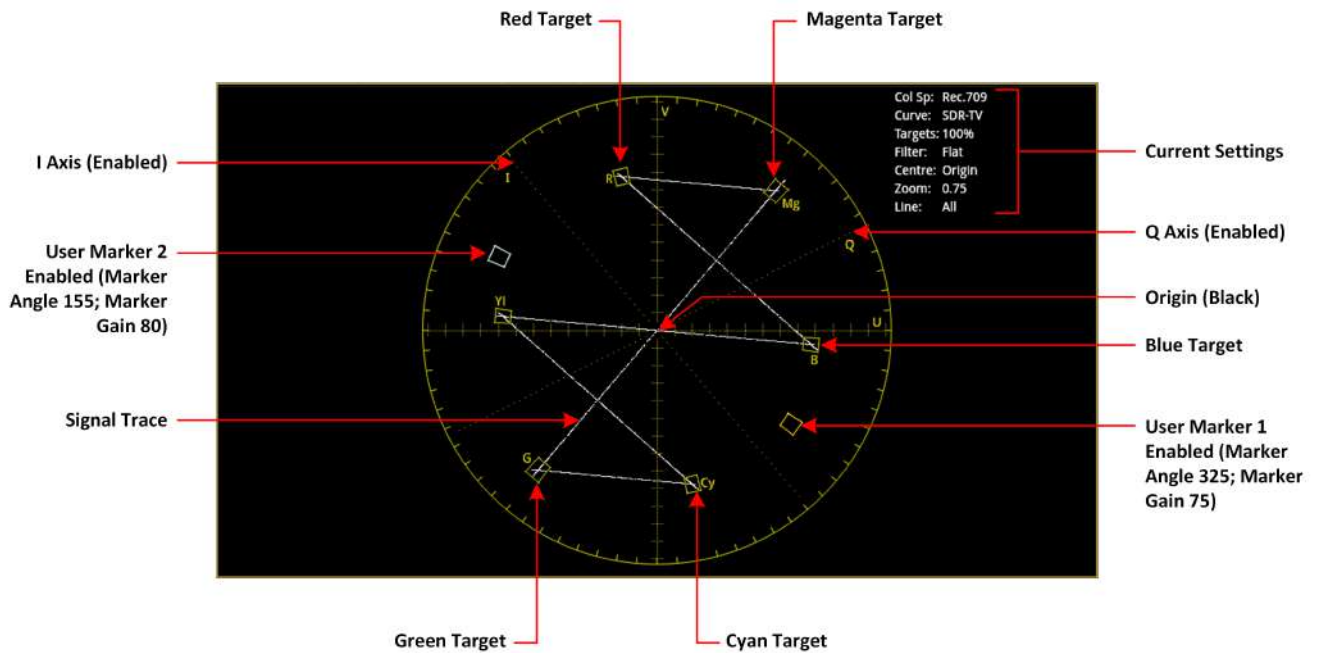

Figure 9-29: Analyzer - Vectorscope Instrument

Instrument Menu Options

The following table lists the configurable parameters in the Analyzer - Vectorscope instrument submenu:

Table 9-4 : Analyzer - Vectorscope Options

Item	Options	Description
Targets	Off (Default) 75% 100%	If selected, set the display graticule scale to match either the 75% or 100% color bar positions. When set at 75%, the target represents 75% saturation, and the further from the center of the display, the more saturated that color. At 100%, the target represents 100% saturation.
User Markers (Dec)	Disabled (Default) Enabled	Use and view markers in the vectorscope display. When enabled, displays two new colored sliders for Marker Angle (adjustable in the range 0 and 359.99) and Marker Gain, (adjustable in the range 0 and 100.00). By default, Marker 1 is orange and Marker 2 is blue.
Marker Selected	Marker 1 (Default) Marker 2	When User Markers enabled, sets the focus for Marker Angle and Marker Gain operations to either Marker 1 or

Item	Options	Description
		Marker 2. Note: Marker 1 and Marker 2 are linked to the Cb and Cr traces in the Waveform instrument.
Marker Angle	Marker 1: 0.00 to 359.99 (Default: 0.00) Marker 2: 0.00 to 359.99 (Default: 90.00)	Adjusts the rotational angle of the cursor from its default starting position around the center of the vectorscope.
Marker Gain	Marker 1: 0.00 to 100.00 (Default: 50.00) Marker 2: 0.00 to 100.00 (Default: 50.00)	Adjusts the Gain on the signal from 0 at the origin to 100 at the outer limit of the vectorscope.
I/Q Axes	Off (Default) I Only Q Only Both	When enabled, display either the I axis only, the Q axis only, or both IQ axes together. The scale on the axes represents the vertical lines for each color.
Filter	Technical (Default) Production Low Pass Raw	Select the type of filtering. When you select the Raw option, no filter is applied.
Center	Origin (Default) Red Green Blue Magenta Cyan Yellow Marker 1 Marker 2	Select the origin for the vectorscope display.
Single Line Mode	Disabled (Default) Enabled	When enabled, allows analysis of a single video line by specifying the line number. When disabled, all video lines are overlaid on top of each other.
Line Number	System Control 0 to maximum line number	Displayed when Single Line Mode is enabled to specify the desired line number.
Zoom	0.5 to 4.00 (Default: 1.00)	Zoom into the selected Center; either the origin, a color target, or either of the user markers. Adjust the zoom using the slider.
On Video Loss	Black Screen (Default) Freeze Last Frame	Select what to display in the Vectorscope window in the event of losing the video signal.
Brightness	Slider control: 1 to 31 (Default: 8)	Adjust the brightness of the vectorscope display.
Gamma	Slider control: 1 to 255 (Default: 127)	Adjust the gamma component of the vectorscope display.
Persistence	Slider control: 1 to 255 (Default: 70)	Adjust the persistence of the vectorscope display.

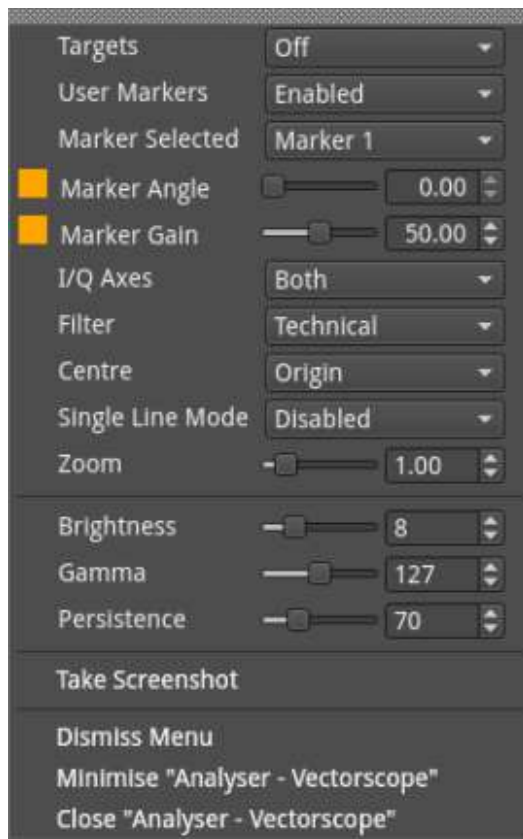

Figure 9-30: Analyzer - Vectorscope Options Menu

Analyzer - CRC Analysis (Optional SDI Input)



Overview

The **Analyzer - CRC Analysis** window checks for CRC (Cyclic Redundancy Check) errors in the received signal. The number of SDI input failures, the last failure time, total analysis time, and error rate are also displayed. Depending on the input required for the standard under test (i.e., quad, dual, or single input) the Sub Image columns will display any errors occurring in each of the Sub images. In the larger window size, the Link rows will display any errors occurring per Link.

Analyser - CRC Analysis		Analysis time: 2h 58m			
Input Failures: 257		Last Failure Time: 11m 6s			
	Sub 1	Sub 2	Sub 3	Sub 4	
C-CRC-Err	0	0	0	0	
Y-CRC-Err	0	0	0	0	
ANC-CS-Err	1	0	0	0	
Rate (/s)	0.002	0.000	0.000	0.000	
OK Time	9m 53s	11m 6s	11m 6s	11m 6s	
Active Picture Changes	0	0	0	0	
Active Picture CRC	EC9D CAC0	FE4F 7B21	EC9D CAC0	FE4F 7B21	

Figure 9-31: Analyzer - CRC Analysis Instrument

The **OK Time** shows the length of time an image/sub image has been received without error.

The PHABRIX **Active Picture CRC** is created by the receiver for each image or sub-image video frame (dependent on standard) and displayed.

The instrument detects and counts changes in the active picture CRC. This can be used to show that an SDI path is transparent and error free.

The reported CRC (error) Rate(s) is the number of instances of the addition of the Y- and C-channel CRCs and ANC checksum errors in each second.

- Y- and C-channel CRCs are calculated for each video line in accordance with SMPTE Standards
- ANC checksums are calculated for each individual ANC packet.

Errors are collected from the analysis start time and the reported error rate per second is the total number of errors divided by the total time of analysis.

Instrument Menu Options

The following table lists the configurable parameters in the Analyzer - CRC Analysis instrument submenu:

Table 9-5 : Analyzer - CRC Analysis Options

Item	Options	Description
Ignore CRC on switch lines	Disabled (Default) Enabled	When enabled, ignores CRC errors on the switching line.
Reset errors on Input failure	Disabled (Default) Enabled	When enabled, clears the counters on input failure if required.
Reset errors and running time	System Control	Use this control to reset CRC errors and running time.

Audio Signal Analysis Instruments

This chapter describes the Audio analytical Instruments and includes the following sections:

- [Analyzer - Audio Channel Status](#)
- [Analyzer - Audio Meters](#)
- [Analyzer - Loudness Monitor](#)
- [Analyzer - Dolby Metadata](#)

Analyzer - Audio Channel Status



Overview

The **Analyzer - Audio Channel Status** Instrument displays detailed information about the available audio channels.

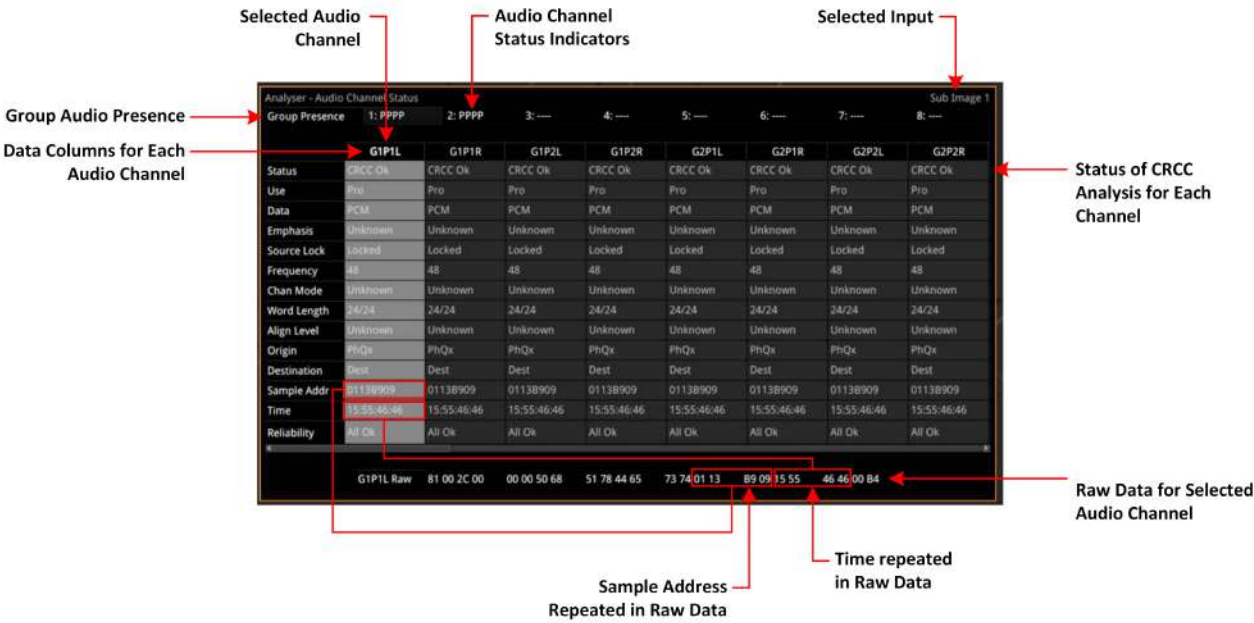

Figure 10-1: Analyzer - Audio Channel Status Instrument (ST 2022-6 IP and Optional SDI Input)

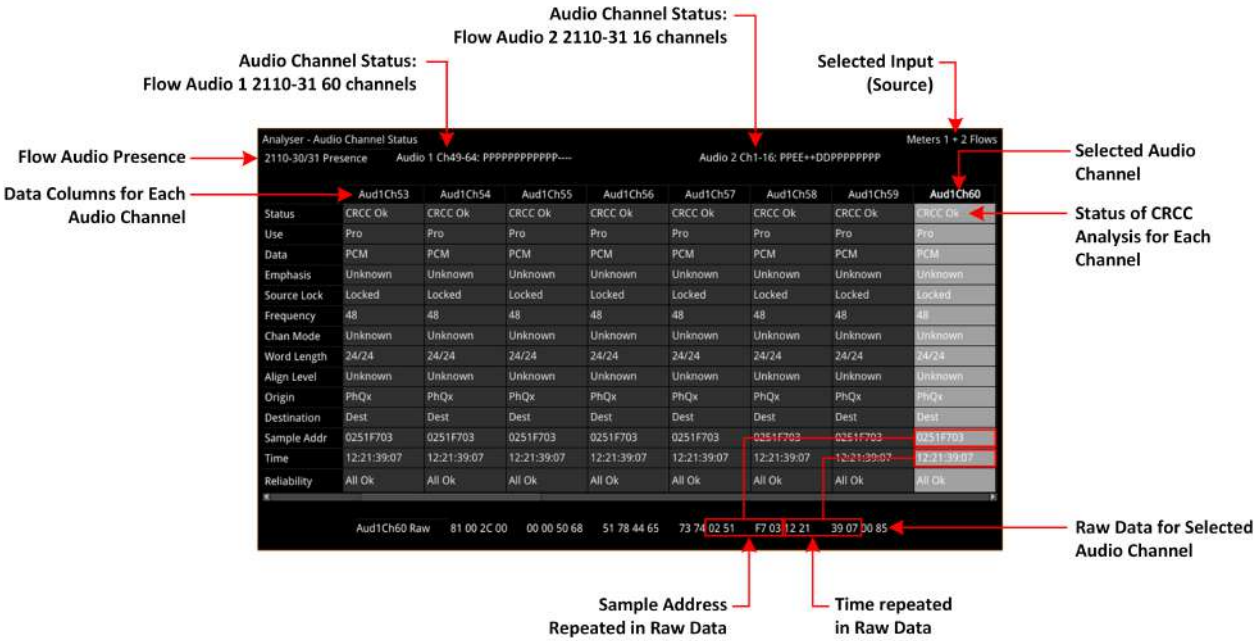

Figure 10-2: Analyzer - Audio Channel Status Instrument (ST 2110 IP Input)

The Group Presence is defined in the upper row of the **Analyzer - Audio Channel Status** display. For each channel, one of the following channel status indicators is displayed:

- : No audio
- P: PCM audio present

- **D**: Dolby Digital® packets present
- **+**: Dolby Digital Plus™ packets present
- **E**: Dolby E™ packets present
- **2**: Dolby ED2™ packets present
- **?**: Unspecified data present.

If you hover the cursor over one of the status indicators, the following tooltip is displayed:

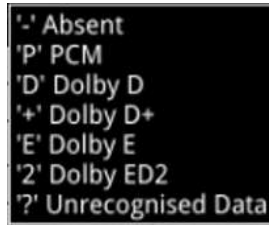

Figure 10-3: Audio Channel Status Tooltip

In addition, the following information is displayed in the main data table for each audio channel:

- **Channel Status:** Result of the cyclical redundancy check checksum (CRCC), for example: CRCC Ok.
The status table uses the following color-coding to indicate CRCC errors:
 - If the channel status is in error, the text is displayed in a red font
 - If errors have occurred but are no longer present the text is displayed in a yellow font
 - If no errors are present, the text is displayed in a white font.
- **Use:** Intended purpose of the audio signal.
- **Data Type:** Digital sampling method employed, for example: PCM (pulse-code modulation)
- **Emphasis:** Type of signal pre-emphasis applied to the audio signal.
- **Source lock:** Indicates whether the source is locked to an external time sync, for example: Locked
- **Frequency:** Audio sample frequency in kHz, for example: 48
- **Channel Mode:** Represents the relationship between each audio channel pair.
- **Word Length:** Represents the audio word length, for example: 24/24
- **Align Level**
- **Origin:** Four ASCII characters indicating the channel origin, for example: **PhQx**
- **Destination:** Four ASCII characters indicating channel destination
- **Sample Address:** A rolling counter that increments with each 48 kHz audio sample
- **Time:** Local time of the encoded audio
- **Reliability:** Contains information about the reliability of the channel status word, for example: All Ok.

Use the horizontal and vertical scroll bars to view the full table of channel columns and audio status parameters.

Raw Data Display

You can click on an audio channel column to select it and display the raw data for that channel in the bottom row of the window.

Each AES3 audio sample, includes the Sample Address and Time occupying eight bytes (14 to 21) with a reliability indication in byte 22 and the cyclical redundancy check checksum (CRCC) in byte 23. With each audio sample, the Sample Address and Time are different for each sample, so bytes 14 to 21 will change, as will the checksum in byte 23.

Instrument Menu Options

The following configurable parameters are available to configure the **Analyzer - Audio Channel Status** Instrument:

Table 10-1 : Analyzer - Audio Channel Status Menu Options

Item	Options	Description
Input Select (ST 2022-6 IP and Optional SDI input)	Sub Image 1, Sub Image 2, Sub Image 3, Sub Image 4, AES IO	Selects the target input audio source for analysis. The selected input is displayed in the top-right corner of the instrument.
Input Select (ST 2110 IP input)	<p>With one x 80 channel audio flow selected:</p> <ul style="list-style-type: none"> • AUD 1: Channels 1 - 32 • AUD 1: Channels 33 - 64 <p>With two x 64 channel audio flows selected:</p> <ul style="list-style-type: none"> • AUD 1: Channels 1 - 32 • AUD 1: Channels 33 - 64 • AUD 2: Channels 1 - 32 • AUD 2: Channels 33 - 64 <p>With four x 32 channel audio flows selected:</p> <ul style="list-style-type: none"> • AUD 1: Channels 1 - 32 • AUD 2: Channels 1 - 32 • AUD 3: Channels 1 - 32 • AUD 4: Channels 1 - 32 <p>AES IO</p> <p>Note: in 2110-31 the number of channels is limited to 1 - 60 for a 125 μs packet time</p>	For ST 2110 IP input, you can choose the audio flows currently selected on both Analyzer - Audio Meters windows, or AES IO. Audio Channel Status information will only be available with a flow using ST 2110-31 (AES 3 transport) or an AES input.



Overview

The **Analyzer - Audio Meters** instrument displays 16 audio meters together with peak level indicators and indication of audio pair correlation. In addition, the numeric values are displayed in dBFS below each meter.

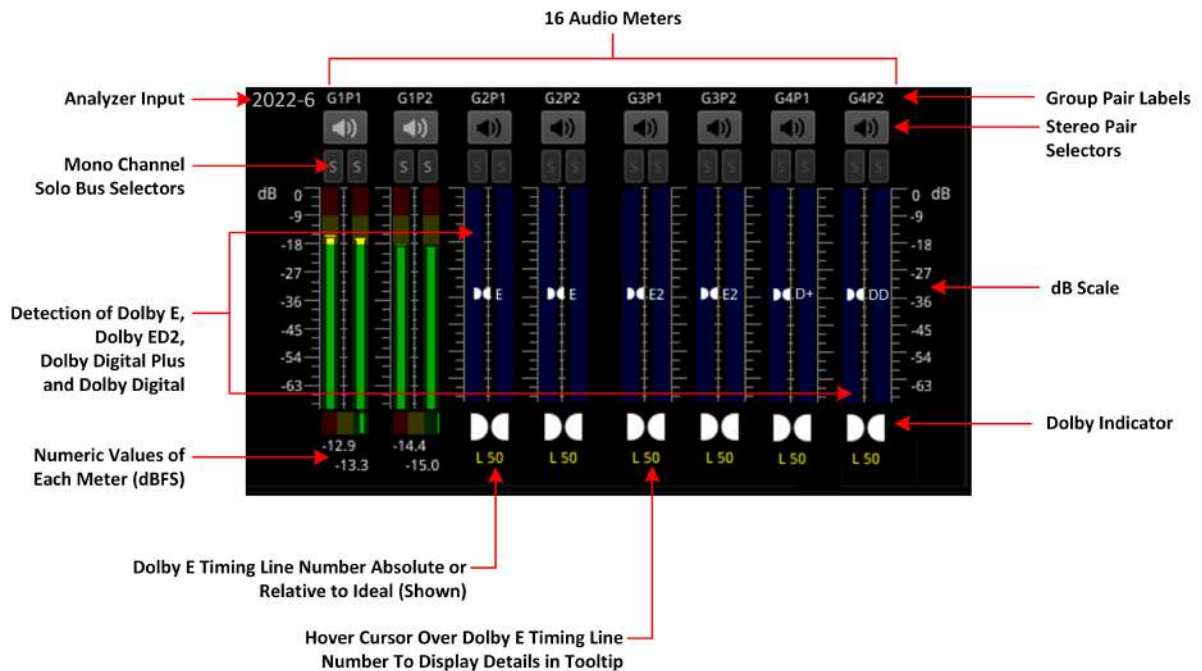

Figure 10-4: Analyzer - Audio Meters Instrument (ST 2022-6 IP and Optional SDI Input)

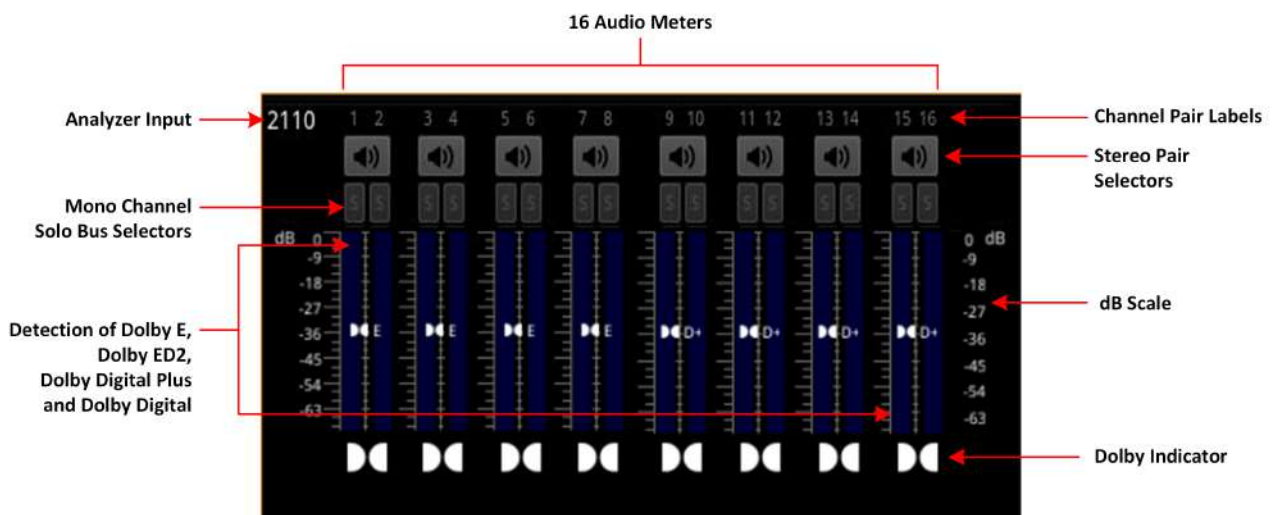

Figure 10-5: Analyzer - Audio Meters Instrument (ST 2110 IP Input)

Dolby E™, Dolby ED2™, Dolby Digital® and Dolby Digital Plus™ streams are automatically detected by the system with Dolby® stream presence indicated in blue. For an SDI input carrying embedded Dolby E audio, the Dolby E timing line number is also displayed below the detector, either as an absolute value or relative to the *Ideal* line number specified for that video standard.

The HDMI instrument output carries a stereo pair of audio, as does the SDI instrument output. The same signal is made available on pins 7 and 8 of the 26-way D-type connector on the rear of the chassis.

To monitor a stereo pair, select the speaker icon above the target audio meter. To select a mono channel, click the corresponding solo bus located between the audio meters and the speaker icons.

You can enable up to two audio meter instrument windows providing 32 simultaneous channels of audio metering. Each window can be assigned to monitor groups 1 to 4 (defined in SMPTE ST 299-1) or groups 5 to 8 (defined in SMPTE ST 299-2) in any of up to four potential sub-image ANC areas as defined in SMPTE ST 2082-10. You can scale the size of each audio window to occupy from 1/32 to 1/4 of the screen area.

[Figure 10-6](#) provides a comparison of the available audio metering scale options and illustrates the relative scope and alignment levels. For each scale you can select an appropriate ballistic option.

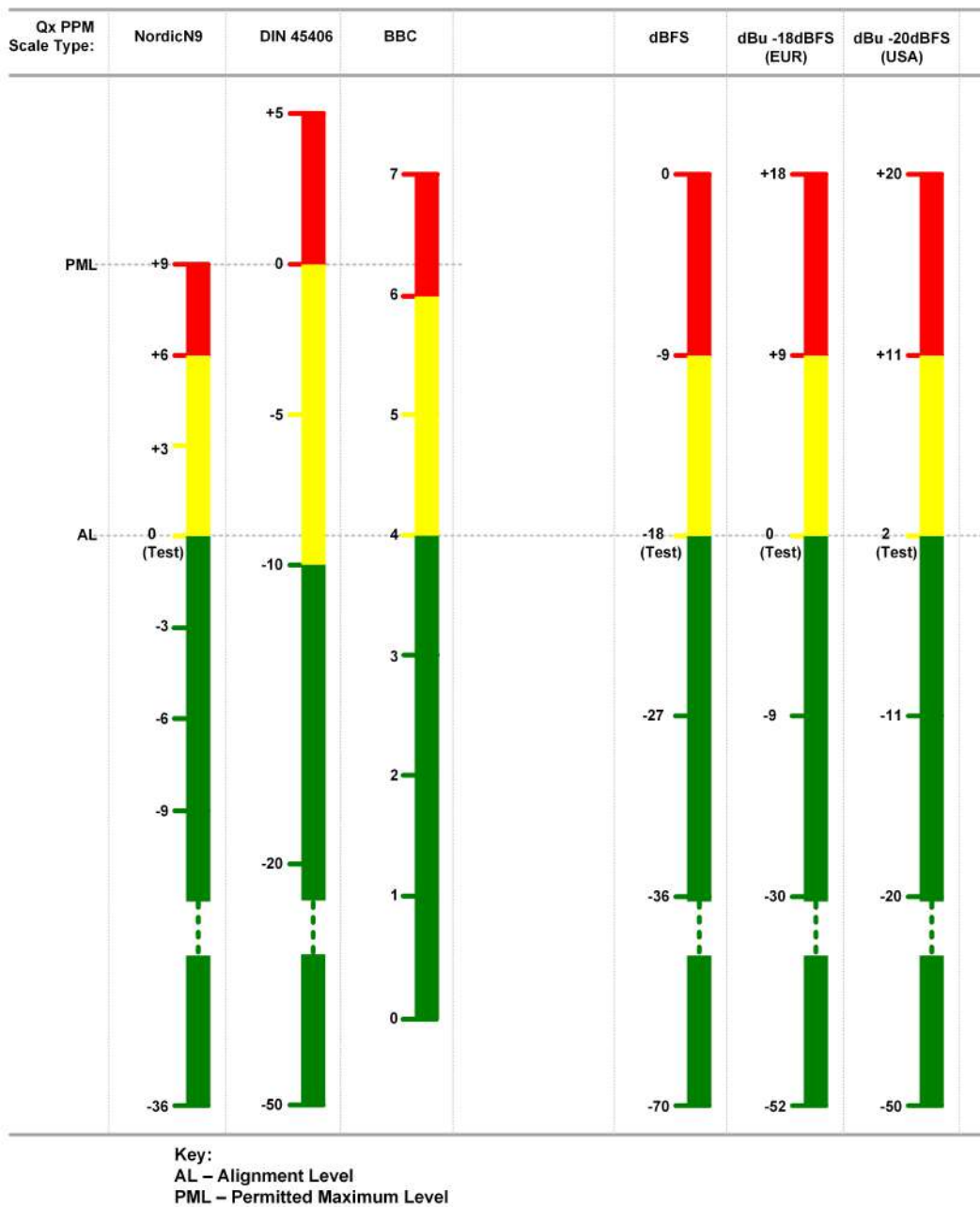

Figure 10-6: Comparison of Audio Metering Scales

Audio Group Metering (ST 2110 IP Input Only)

In the [IP Receive - Flows](#) instrument (ST 2022-6 and ST 2110 IP input) you can select either of the multiple flows: two audio flows (AUD 1 and AUD 2 providing 2 x 64 channels) or four audio flows (AUD 1 to AUD 4 providing 4 x 32 channels) for audio group metering. When you select either 2 x 64 channels or 4 x 32 channels you can set-up **audio group metering** in the Audio Meters instrument as follows:

- With 2 x 64 channels active, select **AUD 1,2 : Channels 1-8** from the **Input Select** dropdown.

This allows you to meter the first eight channels of AUD 1 in the first eight audio meters of the Audio Meters instrument, and the first eight channels of AUD 2 in the next eight audio meters. The remaining 112 channels are unmetred.

- With 4 x 32 channels active, select **AUD 1,2,3,4 : Channels 1-4** from the **Input Select** dropdown.

This allows you to meter the first four channels of AUD 1 in the first four audio meters of the Audio Meters instrument, the first four channels of AUD 2 in the next four audio meters, the first four channels of AUD 3 in the next four audio meters and finally the first four channels of AUD 4 in the remaining four audio meters. The remaining 112 channels are unmetred.

To identify the source flow and channels currently being metered, hover the mouse cursor over any of the 16 meters to display a tooltip, as shown in [Figure 10-7](#).

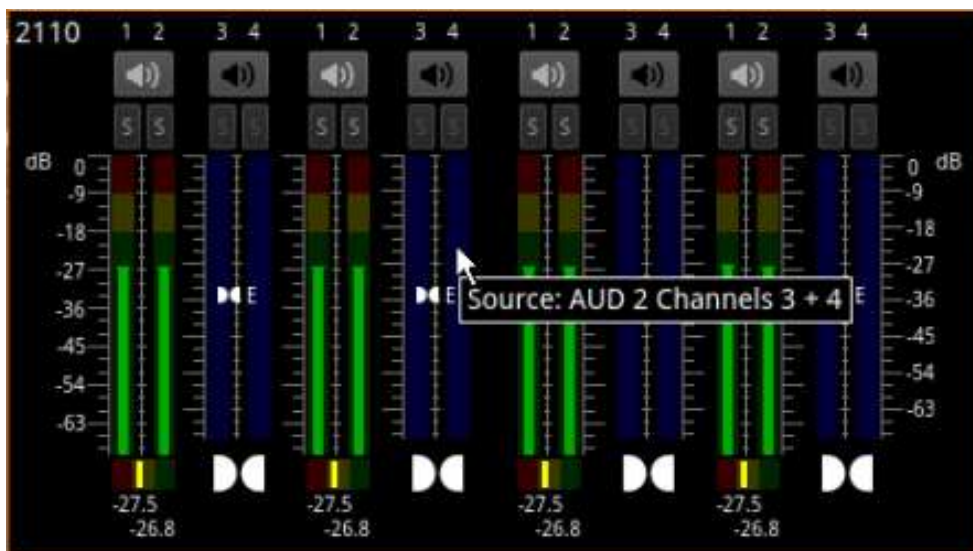

Figure 10-7: Audio Group Metering Tooltip (ST 2110 Input)

Using the Dolby E Decoder

Requires Option(s):	PHQXLO-DOLBY
---------------------	--------------

In order to meter the *output* of the Dolby® decoder, with the **PHQXLO-Dolby** license installed, select **Dolby Decoder** from the **Input Select** dropdown in the Options Menu.

To enable the Dolby decoder to decode the audio signal, select both the **Dolby Location** (ST 2022-6 and optional SDI input: Sub-Image *n*, AES; ST 2110 IP Input: AUD 1 to AUD 4, AES) *and* the **Dolby Source** (ST 2022-6 IP or optional SDI input: G1P1, etc.; ST 2110 IP input: Ch 1-2, Ch 3-4, etc.) from the Options menu. When selected, the Dolby E Decoder displays five pairs of audio meters (a ten channel audio meter.) The first four meters display the eight channels of audio in the Dolby E or ED2 stream. The fifth audio meter displays the Left and Right stereo 2.0 channels of the Downmix Engine.

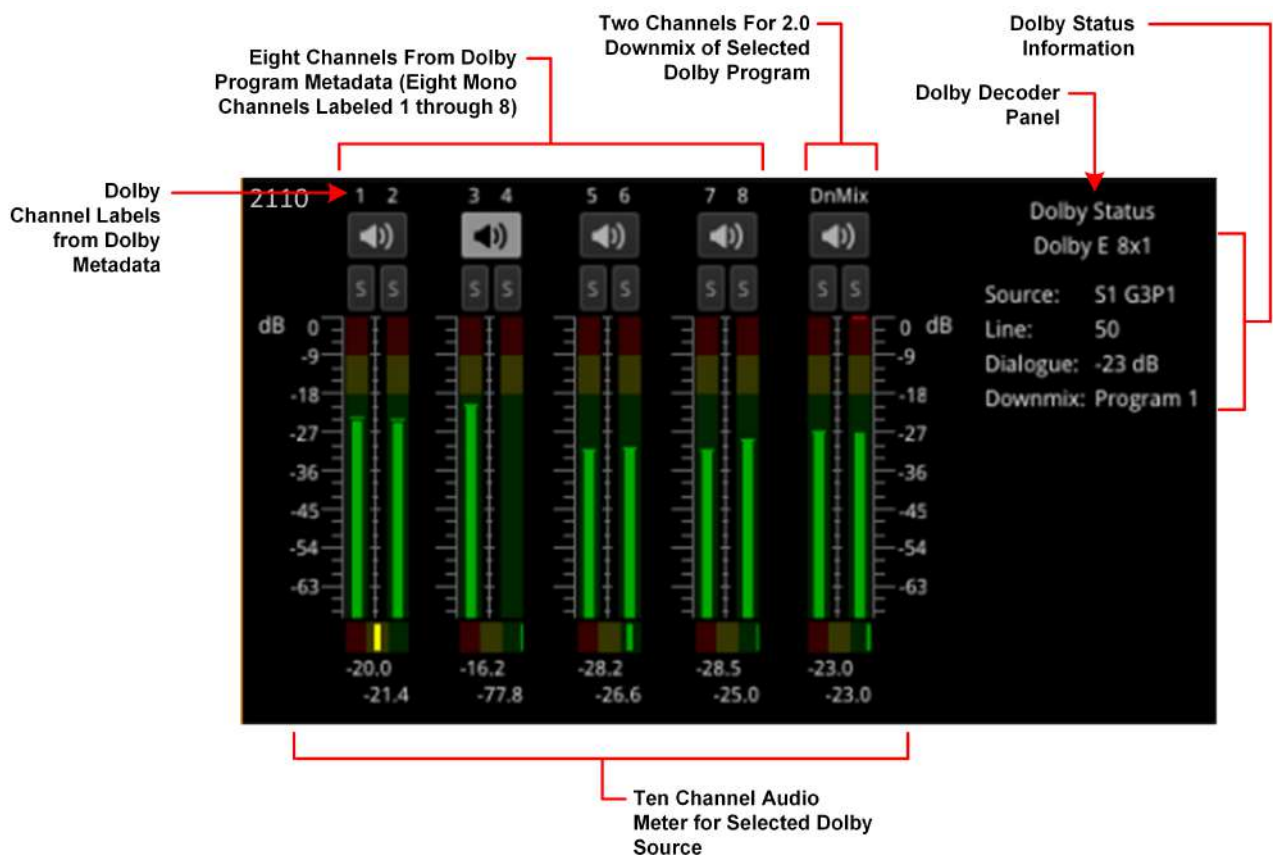

Figure 10-8: Dolby E Decoder Selected in Audio Meters (ST 2110 IP Input)

You can also select the input to the Downmix Engine (for example, when downmixing from 5.1 to 2.0) by choosing the appropriate **Dolby E Downmix Program** source from the Options menu.

The Dolby E decoder will provide up to eight decoded program outputs, depending on how many programs are in the Dolby E or Dolby ED2 source. The unit provides the facility to preselect a program to be downmixed (i.e., the input to the downmixer) that may not currently be present in the source, but may be available in the future.

Note: The Downmix is part of the Dolby Decoder block and can only downmix content that is actively being decoded by the decoder. It is not possible to downmix a PCM source.

In addition, a Dolby Status panel provides the following information on the status and context of the decoded Dolby audio configured through the Options menu:

- Channel configuration, for example, 5.1+2
- Active Dolby Source input to the Dolby decoder, either as Flow and Channel (ST 2110 IP input) for example, **AUD1 1/2**, or as SDI Substream and Channel (ST 2022-6 and optional SDI input) for example, **S1 G2P2**
- Dolby Line Number (ST 2022-6 IP and optional SDI input only)
- Dialogue Level metadata value
- Source of the Dolby downmix, that is, the program within the Dolby E stream.

The ten available channels are labeled according to the Program metadata in the Dolby audio feed (eight channels, together with a meter for a two program downmix of the selected Dolby E Downmix Program (**Program 1** through **Program 8** selected in the Dolby Encode Options menu.)

For example, for a selected **5.1+2** program, the columns are labeled as follows:

- **L1:** Left 1
- **R1:** Right 1
- **C:** Center
- **LFE:** Low Frequency Effects
- **Ls:** Left Surround
- **Rs:** Right Surround
- **L2:** Left 2
- **R2:** Right 2
- **DnMix:** Stereo downmix channels

For example, for a selected program with eight mono channels, the columns are labeled: **1, 2, 3, 4, 5, 6, 7, 8, DnMix**

For more information on the Dolby Metadata, launch the **Analyzer - Dolby Metadata** instrument, see the section [Analyzer - Dolby Metadata](#).

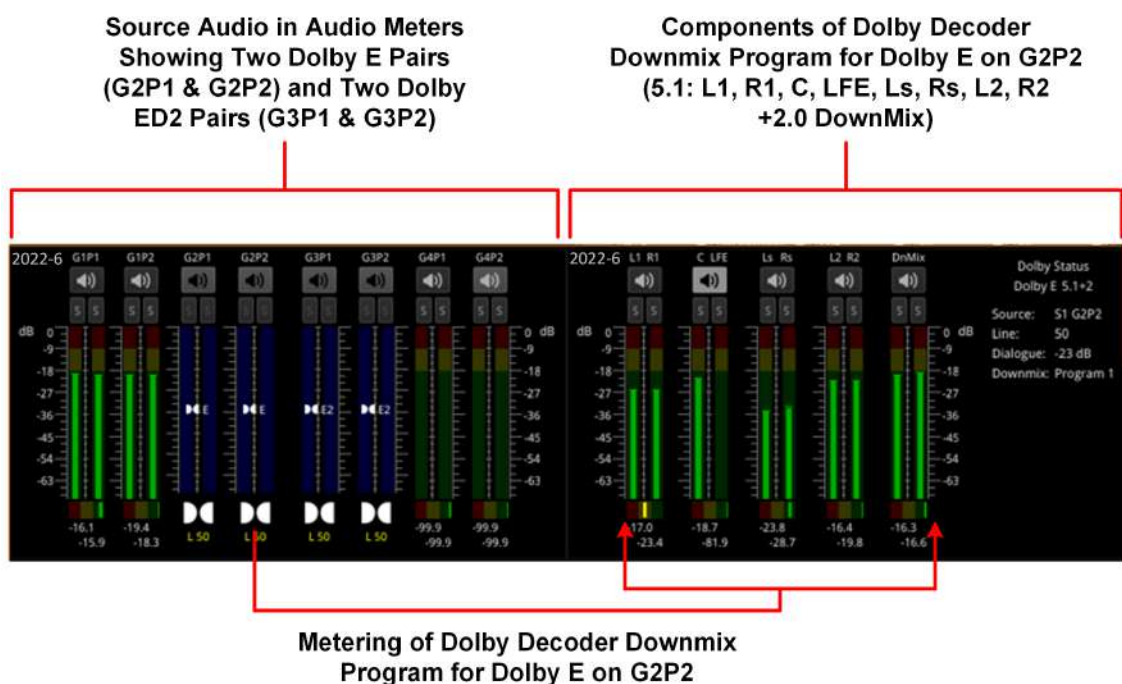
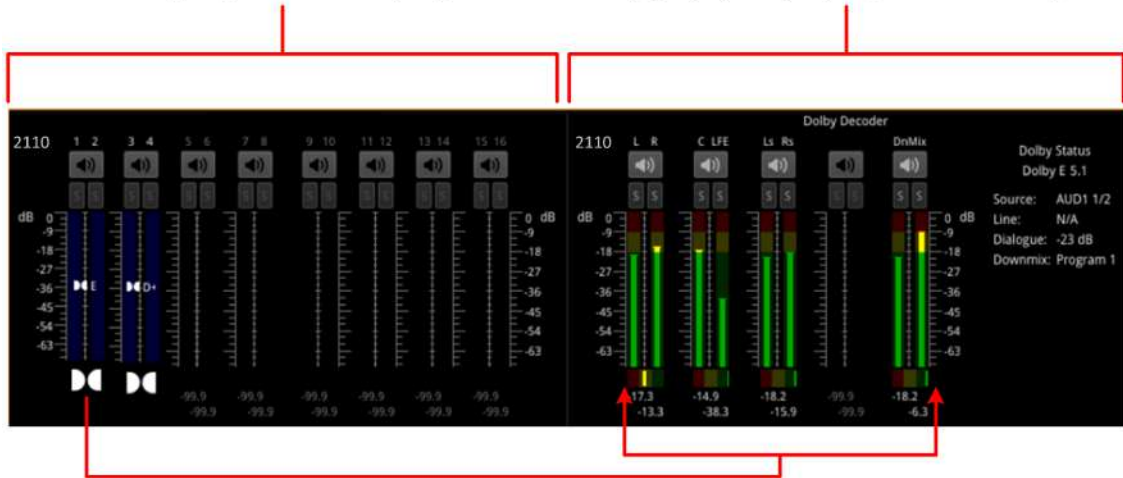

Figure 10-9: Audio Meters and Dolby Decoder Instruments (ST 2022-6 IP and Optional SDI Input)

Source Audio in Audio Meters
Showing a Dolby E Pair (1/2)
&
Dolby Digital Plus Pair (3/4)

Components of Dolby Decoder
Downmix Program for Dolby E on
AUD1, Pair 1/2
(L, R, C, LFE, Ls, Rs, +2.0 DownMix)



Metering of Dolby Decoder Downmix
Program for Dolby E on Pair 1/2

Figure 10-10: Audio Meters and Dolby Decoder Instruments (ST 2110 IP Input)

Instrument Menu Options

The following configurable parameters are available to configure the **Analyzer - Audio Meters** Instrument:

Table 10-2 : Analyzer - Audio Meter Menu Options

Item	Options	Description
Input Select (ST 2022-6 IP and Optional SDI Input)	Image/Sub Image 1 Group 1-4 Image/Sub Image 1 Group 5-8 Sub Image 2 Group 1-4 Sub Image 2 Group 5-8 Sub Image 3 Group 1-4 Sub Image 3 Group 5-8 Sub Image 4 Group 1-4 Sub Image 4 Group 5-8 AES IO Dolby Decoder (Requires Option: PHQXLO-DOLBY)	Select the source for each pair of audio meters to meter simultaneously up to 32 audio channels in up to two Audio Meter instrument windows. When Option PHQXLO-Dolby is installed, you can also control and configure the Dolby Decoder and select its output.
Input Select (ST 2110 Input)	With Audio Flows set to 1x 80 Channel: AUD 1: Channels 1 - 16 AUD 1: Channels 17 - 32 AUD 1: Channels 33 - 48 AUD 1: Channels 49 - 64 AUD 1: Channels 65 - 80 With Audio Flows set to 2x 64 Channels: AUD 1: Channels 1 - 16 AUD 1: Channels 17 - 32 AUD 1: Channels 33 - 48 AUD 1: Channels 49 - 64 AUD 2: Channels 1 - 16 AUD 2: Channels 17 - 32 AUD 2: Channels 33 - 48 AUD 2: Channels 49 - 64 AUD 1,2 Channels 1 - 8 With Audio Flows set to 4x 32 Channels: AUD 1: Channels 1 - 16 AUD 1: Channels 17 - 32 AUD 2: Channels 1 - 16 AUD 2: Channels 17 - 32 AUD 3: Channels 1 - 16 AUD 3: Channels 17 - 32 AUD 4: Channels 1 - 16 AUD 4: Channels 17 - 32 AUD1,2,3,4 Channels 1 - 4: (AUD1,2,3,4: 4-4-4-4) AUD1,2,3,4: 2-6-4-4) AES IO Dolby Decoder (Requires Option: PHQXLO-DOLBY)	Select the audio channels corresponding to the audio flows selected in IP Receive - Flows , AUD 1, AUD 2, AUD 3 or AUD 4 for metering in up to two Audio Meter instrument windows. Note: in 2110-30: One active received flow comprises 1 - 80 channels, whereas two active received flows comprise two times 1 to 64 channels. When Option PHQXLO-DOLBY is installed, you can also control and configure the Dolby Decoder and select its output.

Item	Options	Description
Ballistics	PPM Type I PPM Type II Vu VuFr Fast	Set the required peak program meter (PPM) ballistic responsiveness setting for the audio meters. PPM Type I emulates the performance of IEC 60268-10 Type I PPM style audio meters typically used by German broadcasters. PPM Type II emulates the performance of IEC 60268-10 Type II PPM style audio meters typically used by UK broadcasters. Vu emulates the performance of IEC 60268-17 Type I PPM style audio meters typically used by US and Australian broadcasters. VuFr emulates the performance of ITU-R Rec BS.645 style audio meters typically used by French broadcasters. Fast provides instantaneous attack ballistics.
PPM Scale	dBFS dBu -18dBFS dBu -20dBFS BBC DIN45406 NordicN9	Set the desired scale for the audio meters according to your standard operating model. The displayed graticule and audio levels change accordingly to reflect the selected scale.
Hat hold time	0.00...10.00, infinite	Sets the minimum time that the signal gate is held open in ms.
Monitor Buttons	Enabled (Default) Disabled	Toggle the display of Monitor icons for the audio meters.
Solo Buttons	Enabled (Default) Disabled	Toggle the display of Solo icons for each channel of a pair.
Dolby E Line Number (ST 2022-6 and Optional SDI Input)	Relative to Ideal (Default) Absolute	Select whether to display the Dolby E timing line number relative to the ideal for the selected standard, or as an absolute line number. The line number is shown in red font if it is outside the valid range (not the ideal range).
Dolby Options - Requires Option: PHQXLO-DOLBY		
Note: The following controls are duplicated in the Dolby Metadata instrument. The Source selection affects the Dolby Decoder and consequently also affects both the Audio Meter and the Dolby Metadata instruments.		
Dolby Source (ST 2022-6 and Optional SDI Input)	None G1P1 G1P2 G2P1 G2P2 G3P1 G3P2 G4P1 G4P2 G5P1 G5P2 G6P1 G6P2 G7P1 G7P2 G8P1	Select the source for each audio pair configured as the Dolby source.

Item	Options	Description
	G8P2	
Dolby Source (ST 2110 IP Input)	For 2110-30 at 125 µs packet size: None Ch 1-2 Ch 3-4 Ch 5-6 Ch 7-8 Ch 9-10 ... Ch 31-32 (Audio Flows set to 4x 32) Ch 63-64 (Audio Flows set to 2x 64) Ch 79-80 (Audio Flows set to 1x 80)	Select the source for each audio channel pair configured as the Dolby source. Notes: <ul style="list-style-type: none"> For 2110-31 at 125 µs packet size, the number of channels is restricted to 60. For 2110-30 at 1 ms packet size, the number of channels is restricted to 10 For 2110-31 at 1 ms packet size, the number of channels is restricted to 7
Dolby Source (When AES Selected as Dolby Location)	None AES 1 AES 2 AES 3 AES 4	Select the source for each AES audio input configured as the Dolby source
Dolby Location (ST 2022-6 IP and Optional SDI Input)	Sub Image 1 Sub Image 2 Sub Image 3 Sub Image 4 AES	Select the appropriate sub-image or the AES input as the location of the Dolby metadata.
Dolby Location (ST 2110 IP Input)	With Audio Flows set to 1x 80 Channel: AUD1 AES With Audio Flows set to 2x 64 Channel: AUD1 AUD2 AES With Audio Flows set to 4x 32 Channel: AUD1 AUD2 AUD3 AUD4 AES	Select the appropriate flow or the AES input as the location of the Dolby metadata.
Dolby E Downmix	Program <i>n</i>	Select the desired Dolby E downmix program from Program 1 to Program 8.
Dolby E Downmix Mode	LoRo (Default)	Select the desired Dolby E downmix mode.
Dolby E Downmix Metadata	Legacy Extended (Default)	Legacy sets the downmix parameters to the center downmix level and the surround downmix level. Note: If Legacy mode is selected but legacy metadata is not available, the unit uses the selected Extended Downmix Metadata parameters. Extended sets the downmix parameters to the Lo/Ro (or Lt/Rt) center downmix level and surround downmix level.

Item	Options	Description
		Note: If Extended mode is selected or being used and Extended metadata is not available, the downmix will revert to using the last set levels.

Analyzer - Loudness Monitor



Overview

The **Analyzer - Loudness Monitor** instrument enables the metering and monitoring of loudness on the configured audio channels for either a stereo audio pair, a 5.1 surround sound audio group, or a decoded Dolby E program.

The Loudness Monitor provides the following Loudness meters:

- **M**: Momentary loudness meter
- **S**: Short-term loudness meter
- **I**: Integrated loudness meter.

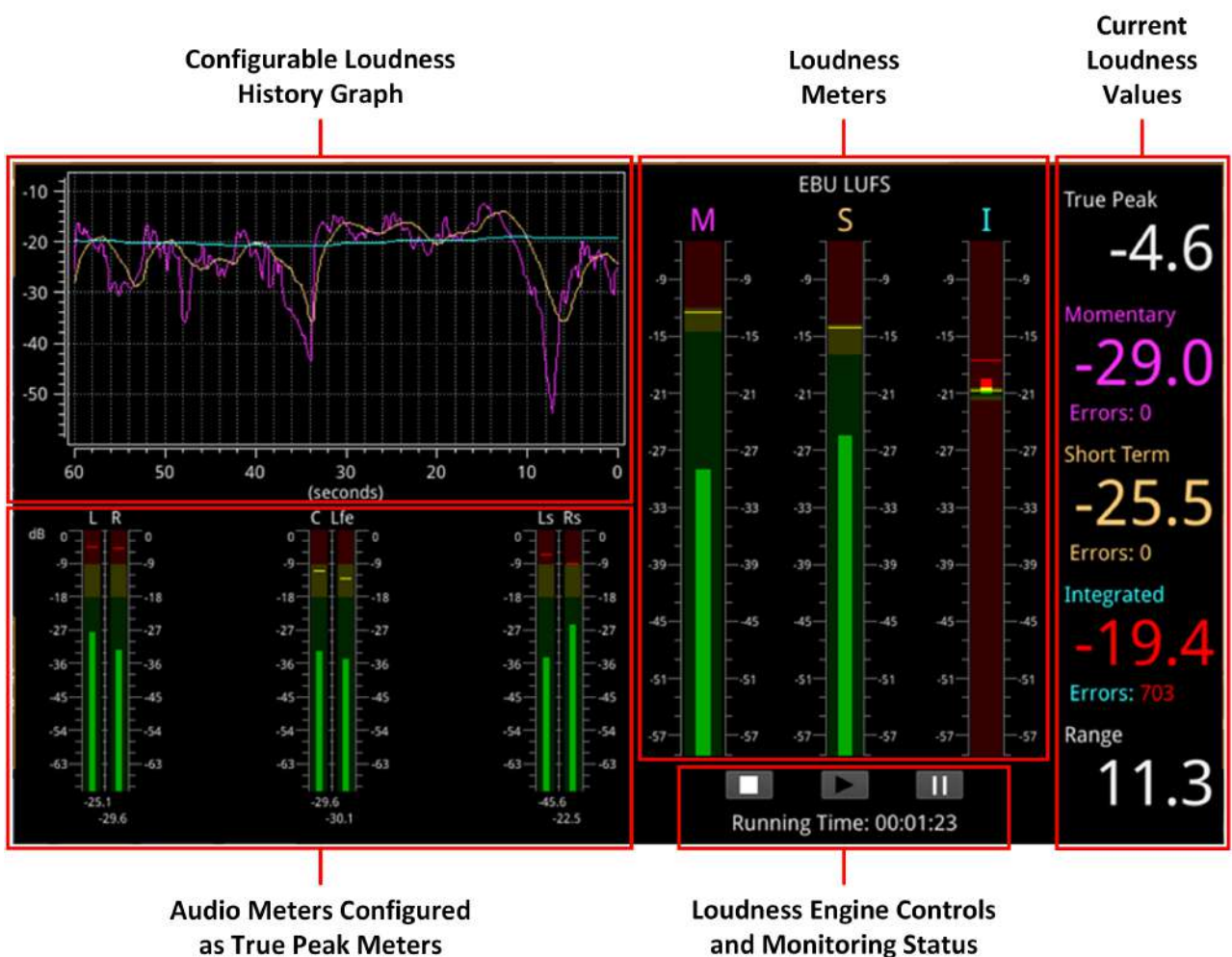

Figure 10-11: Analyzer - Loudness Monitor Instrument

Loudness is measured in accordance with the standards EBU Recommendation R128 and ITU-R BS-1770 which define the measurement over different time periods in terms of either:

- EBU Loudness Units Full Scale (**EBU LUFS**)
- EBU Loudness Units (**EBU LU**)
- ITU Loudness K-weighted Full Scale (**ITU LKFS**)
- ITU Loudness Units (**ITU LU**)

The right-hand section of the Loudness window displays the actual loudness values of the assigned audio channels both graphically, in the three loudness meters and numerically, in the current values for Integrated, Momentary and Short Term loudness. This section also displays the True Peak value, together with a value for the Loudness Range.

When below the configured loudness target and tolerance, the momentary, short-term and integrated values are displayed in the same color as their corresponding loudness meter. If the loudness value exceeds the configured tolerance for a particular meter, the corresponding value switches to a red color and an error count is incremented below the value. In addition, if the True Peak value exceeds the configured **True Peak Alarm** threshold, this value also changes color from white to red.

Three media controls below the Loudness Monitors are provided to enable you to start, stop or pause the Loudness Engine and consequently, the loudness monitoring session.

Note: The Loudness Engine controls do not affect the input source/media to the Loudness Monitor.

The left-hand section of the Loudness window displays the Audio Meters acting as inputs to the Loudness Monitor, together with a Loudness History graph, plotting the selected loudness values from the monitoring session in real-time.

For clarity of viewing, you can double-click the Loudness Monitor to display the window in quarter screen size.

The Loudness options menu allows you to:

- Open the **Audio Assignment** dialog to define the loudness monitoring mode and assign the audio input channels for loudness monitoring and measurement, see the section [Audio Assignment for Loudness Monitoring](#). Define the ballistics and PPM scale type for the conventional audio meters (in the Analyzer - Audio Meters instrument) and the True Peak meters in the Loudness Monitor.

Note: The choice of ballistics does not affect the reported true peak values in the true peak meters.

- Set the loudness standard (EBU or ITU) and units (LU, LUFS or LKFS).
- Configure the Loudness History graph.
- Enable or disable the individual loudness meters (M, S, and I).
- Configure target loudness levels and appropriate tolerances for each loudness meter and, in addition, set an alarm for the True Peak loudness value.
- Reset the True Peak value, the loudness monitoring session, or zero accumulated loudness errors.
- Define the logging duration and lifetime of the loudness logfiles and change the naming of the logfiles.

For details, see the section [Instrument Menu Options](#).

Summary Loudness Monitoring Process

When monitoring an audio track or program for loudness, you will need to perform some, or all, of the following steps:

1. Open the **Analyzer - Loudness Monitor** from the PHABRIX launch menu.
2. Open the **Audio Assignment** dialog form the Loudness Options menu. Select the desired audio mode and then assign the appropriate audio inputs, see the section [Audio Assignment for Loudness Monitoring](#).
3. Set the ballistics and scale type for the audio and true peak meters.
4. Select the Loudness standard and appropriate scale for the loudness monitors.
5. Enable which of the three possible loudness meters you want to use.
6. Set the graphing period and choose which traces to display in the Loudness History graph.
7. Set the loudness targets and tolerances for the active loudness meters.
8. Set the true peak alarm threshold.
9. Set the desired log duration and lifetime.
10. Click the **Play** button to start the loudness monitoring session.

These tasks are described in more detail in the following subsections.

Audio Assignment for Loudness Monitoring

You can select the audio inputs from the available audio channels to be monitored for loudness by opening the **Audio Assignment** dialog from the Loudness Options menu.

The unit's Audio Meter instruments can provide up to 32 simultaneous audio channels for either ST 2022-6 IP or optional SDI input, or up to 80 audio channels for ST 2110 IP input.

For ST 2022-6 IP or optional SDI input, you can assign any of the 32 channels of the left/right pairs in Groups 1 to 8 to the stereo or 5.1 audio inputs for loudness monitoring.

For ST 2110 IP input, you can assign any of up to 80 input channels to the stereo or 5.1 audio inputs for loudness monitoring.

First select the desired loudness monitoring **Mode** from the dropdown menu:

Table 10-3 : Audio Assignment Modes for Loudness Monitoring

Audio Modes for ST 2022-6 IP or Optional SDI Input:	Audio Modes for ST 2110 IP Input:
SDI Stereo	IP Stereo
SDI 5.1	IP 5.1
AES Stereo	AES Stereo
AES 5.1	AES 5.1
Dolby Decoder1	Dolby Decoder1

In SDI, AES or IP **Stereo** audio mode, two input audio meters, Left (L) and Right (R) are displayed.

In SDI, AES or IP **5.1** audio mode, all six audio input meters are active as follows:

- Left (L)
- Right (R)
- Center (C)
- Low frequency effects (Lfe)
- Left Surround (Ls)
- Right Surround (Rs).

In **Dolby Decoder1** mode, select one of the available Dolby Decoder configuration programs, see the table [Dolby Program Configuration Settings](#).

Note: The Loudness Monitor supports only the following channel order in surround sound mode 5.1: L, R, C, Lfe, Ls, Rs.
The Audio Assignment dialog then maps the incoming audio to the expected channel order of the Loudness Monitor.

For ST 2022-6 IP or optional SDI input, select the sub-image then the group/pair to use as stereo inputs to the loudness monitor from the dropdown lists. For ST 2110 IP input, select the configured audio flow (AUD 1 to AUD 4) and then assign one of up to 80 available channels (depending on the number of flows) using the selector.



Figure 10-12: Audio Assignment for Loudness Input for ST 2022-6 IP / Optional SDI and ST 2110 IP Input

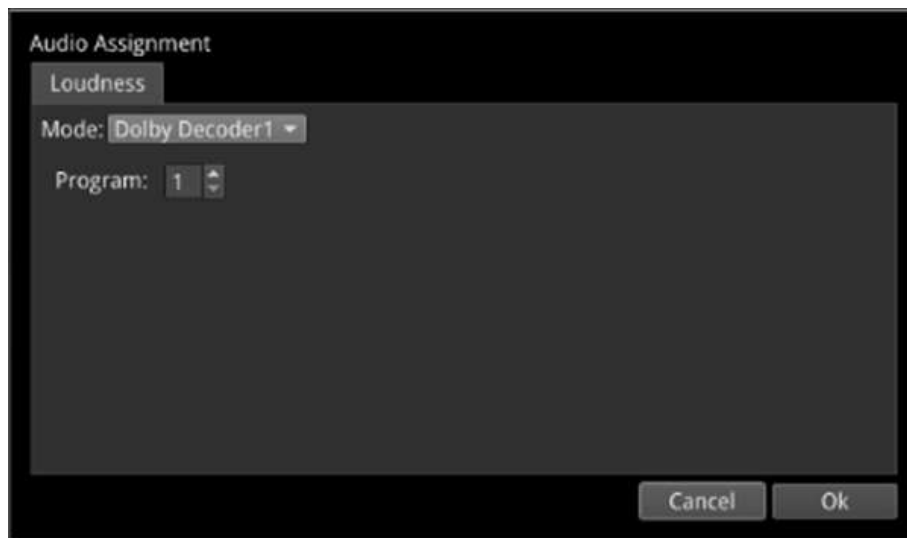

Figure 10-13: Audio Assignment for Loudness Input from the Dolby Decoder

On completion, click **OK** to save your audio input mapping changes.

Audio Meters for Loudness Inputs

The audio meters displayed in the Loudness Monitor display the active audio levels for the selected audio mode and assigned audio channels.

In stereo mode, the two selected input channels are active in the Left (L) and Right (R) audio input meters.

In 5.1 surround sound mode, six input channels are active in all six audio input meters: L, R, C, Lfe, Ls and Rs as shown in the following figure.

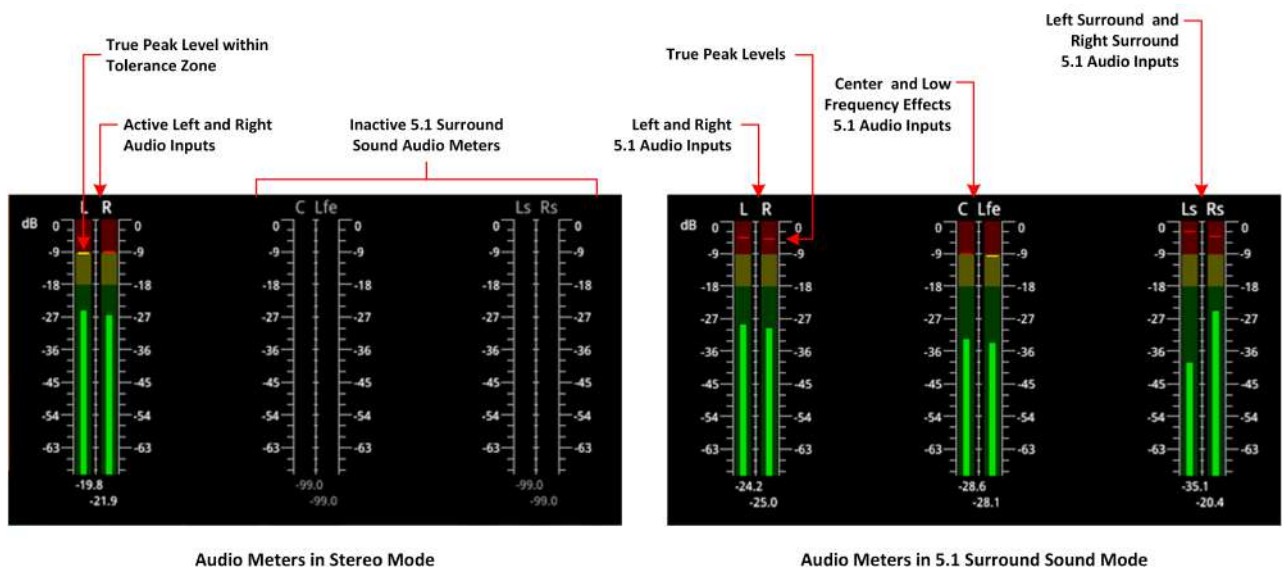

Figure 10-14: Audio Meters for Loudness Inputs in Stereo and 5.1 Surround Sound Modes

The current True Peak levels are also displayed as a horizontal band in each of the active audio meters.

Understanding the Loudness Meters and Values

The Loudness Monitor features three individual loudness meters to measure momentary, short-term and integrated (also known as program loudness) levels across the different time periods defined in the selected standard. You can enable or disable each individual meter using the Options menu and set the Loudness standard and scale. The unit updates the loudness meters every 100 ms.

When enabled, the monitors give a visual indication, in real-time, of the current loudness level with the actual value displayed as a numeric in the right-hand column. The loudness value is also plotted in the Loudness History graph to generate a trace of the loudness trend over time.

The **Momentary (M)** Loudness meter measures the loudness of the audio in a **400 ms** period and then updates the Momentary Loudness displays (numeric value, meter and peak).

The **Short-term (S)** Loudness meter measures the maximum level of all short-term loudness values received over a period of **3 s** monitors and then updates the Short-term Loudness displays (numeric value, meter and peak).

The **Integrated (I)** Loudness meter measures the average loudness over the entire length of the monitoring session, audio track or program and then updates the Integrated Loudness displays (numeric value, meter and peak).

Note: If you hover the mouse cursor over the three loudness meters, the unit displays a tooltip showing the Peak Momentary, Short-term and Integrated values.

The underlying Loudness Engine calculates the Momentary, Short-term and Integrated loudness values and the Loudness meters are the visual representation of the underlying algorithm and calculations.

Each Loudness Meter is color-coded for ease of recognition as follows:

- **Momentary Meter:** **Magenta**
- **Short-term Meter:** **Orange**
- **Integrated Meter:** **Cyan**

The colors of the loudness meters are also reflected in both the numeric loudness values and in the plotted traces in the Loudness History graphs.

When a loudness value for one of the loudness meters is in error, the value is displayed in red.

The configurable **Target Zone** of each meter represents the target loudness of the input audio signal and is displayed as the green background in the meter. When the loudness is within the target range, the numeric value is displayed in the same color as the corresponding meter.

The configurable **Tolerance Zone** of each meter represents the tolerance permitted for the loudness of the signal to be outside the target range and is displayed as the yellow background in the meter. If the tolerance is set to zero (0) or a very low value, you may not see a yellow background section on the meter. When the loudness is within the tolerance range, the numeric value is displayed in the same color as the corresponding meter.

The area of the meter outside the target and tolerance levels represents the loudness Error Zone, or excessive loudness, and is displayed as a red background in the meter.

If the loudness is within the error zone of any of the meters, the corresponding loudness value is displayed in red.

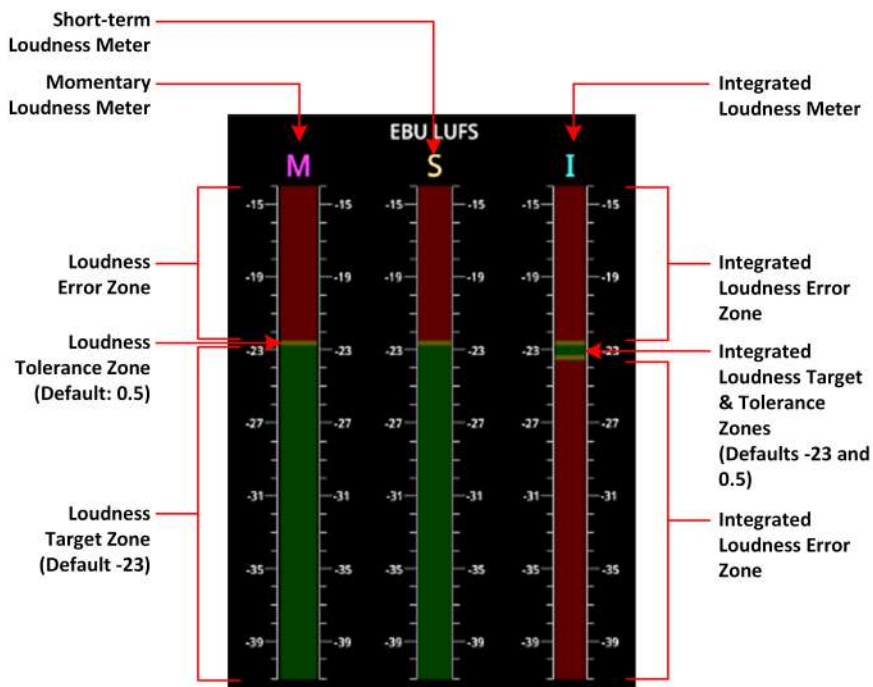

Figure 10-15: EBU LUFS Loudness Meters Showing Default Configuration With No Signal

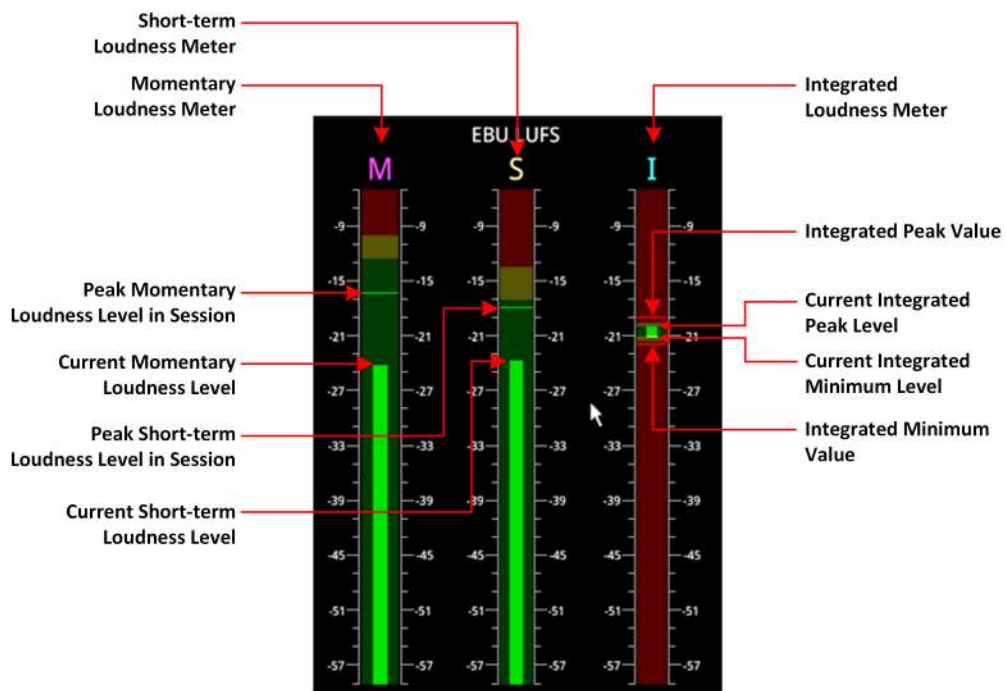

Figure 10-16: Active EBU LUFS Loudness Meters Showing Peak Levels

The unit measures loudness simultaneously, across three different time periods, momentary, short-term and integrated. The current loudness values, displayed to the right of the Loudness meters, are shown in the same color as their corresponding meter, for example, the Momentary Loudness value is magenta, and so on. Only when the value exceeds the configured target and tolerance level does the color of the displayed value change to red to indicate a loudness error condition. Each of the Loudness values is described in the following subsections.

True Peak Value

As specified in the EBU Recommendation EBU-R 128-2020 the True Peak "level of a programme shall not exceed $-1dBTP$ ($dBTruePeak$) during production (linear audio)." The True Peak measurement is calculated from all audio data for each channel and is not affected by the choice of ballistics.

The True Peak value is displayed in white font when below the value of the configurable True Peak Alarm threshold. When the True Peak value exceeds the True Peak Alarm threshold setting, the True Peak value is displayed in red. You can set the True Peak Alarm threshold anywhere in the range from -99.9 to 0 dBFS, with the default set to 0 dBFS.

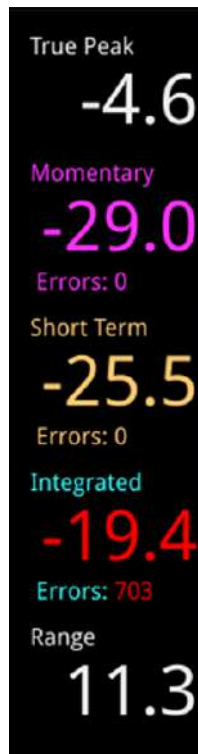

Figure 10-17: Loudness Values Showing Errors on the Integrated Loudness Value

Momentary Loudness Value and Error Count

The Momentary Loudness value, displayed immediately below the True Peak value, represents the loudness value measured across the shortest timescale of 400 ms. The unit updates the value every 100 ms.

If the Momentary Loudness value is above the configured tolerance level then the unit starts to record an error count and the value changes color to red. The error count represents the number of data samples above the target and tolerance threshold.

Short-term Loudness Value and Error Count

The Short-term Loudness value, represents the loudness value measured across a longer timescale of 3 seconds. The unit updates the value every 100 ms.

If the Short-term Loudness value is above the configured tolerance level then the unit starts to record an error count and the value changes color to red. The error count represents the number of data samples above the target and tolerance threshold.

Integrated Loudness Value and Error Count

The Integrated Loudness value represents the average loudness across the entire session or program. The unit updates the value every one second.

If the Integrated value exceeds the tolerance setting, the error counts are recorded, in the same way as for momentary and short term loudness but, in addition, if the value reaches the target then drops below the tolerance, the unit records ten error counts.

Loudness Range Value

The Loudness Range is defined in the EBU Recommendation EBU-R 128-2020 as "*the distribution of loudness within a programme.*" The unit calculates and updates this value every second.

Using the Loudness Controls

The loudness monitoring controls are designed to appear as standard media controls and work in the same way. Use these controls to start, pause, restart and stop the loudness monitoring session. Active controls are displayed as a white icon on a gray background and inactive controls are reversed, as shown in the following graphic.

The following loudness monitoring controls are located below the loudness meters to control the progress of loudness monitoring; from left to right:

- **Stop** - stops the current loudness monitoring and logging session
- **Play** - starts the loudness monitoring and logging session
- **Pause** - pauses the current loudness monitoring and logging session.

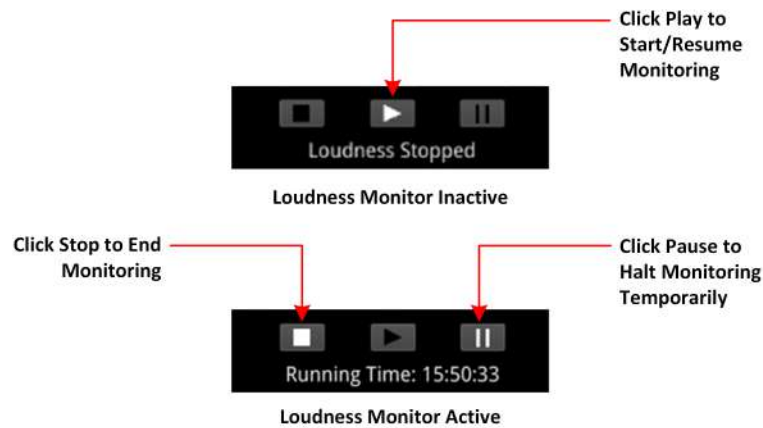

Figure 10-18: Loudness Monitoring Controls

To start a loudness monitoring session, click the **Play** button and to stop the session, click **Stop**. If you want to suspend loudness monitoring temporarily press **Pause**, then either **Play** to resume or **Stop** to end the session.

Note: Pressing **Pause** pauses the current loudness monitoring *and* the logging session. When you press **Play** to resume, the unit continues loudness monitoring using the previous set of audio data and, in addition, restarts the logging session. As a result, the unit re-sets the running-time counter to zero.

You will see the current status of a loudness monitoring session displayed below the controls. If monitoring is in progress, the Loudness Monitor displays the running time of the session, in the format **hh:mm:ss**. If monitoring is paused, or stopped, you will see the messages **Loudness Stopped** or **Loudness Paused**, respectively.

Using the Loudness History Graph

The Loudness History Graph displays a trace of loudness values over a configured time period for each active loudness meter, with the trace displayed in the same color as its associated meter. You can set the displayed graphing period from one minute to a maximum of 10 minutes and the horizontal (x-axis) time scale adjusts accordingly. The vertical (y-axis) scale represents the loudness units for the configured standard, for example, LUFS, LKFS, or LU. The scale values adapt automatically to the loudness values being monitored.

If you position the cursor over any point in the History Graph, the unit displays a tooltip containing the following information:

- Current actual time
- Elapsed time in the loudness monitoring session
- Momentary loudness value at that point (if active)
- Short-term loudness value at that point (if active)
- Integrated loudness value at that point (if active)

If you stop loudness monitoring using the loudness controls and then start another session, the content is cleared from the History Graph.

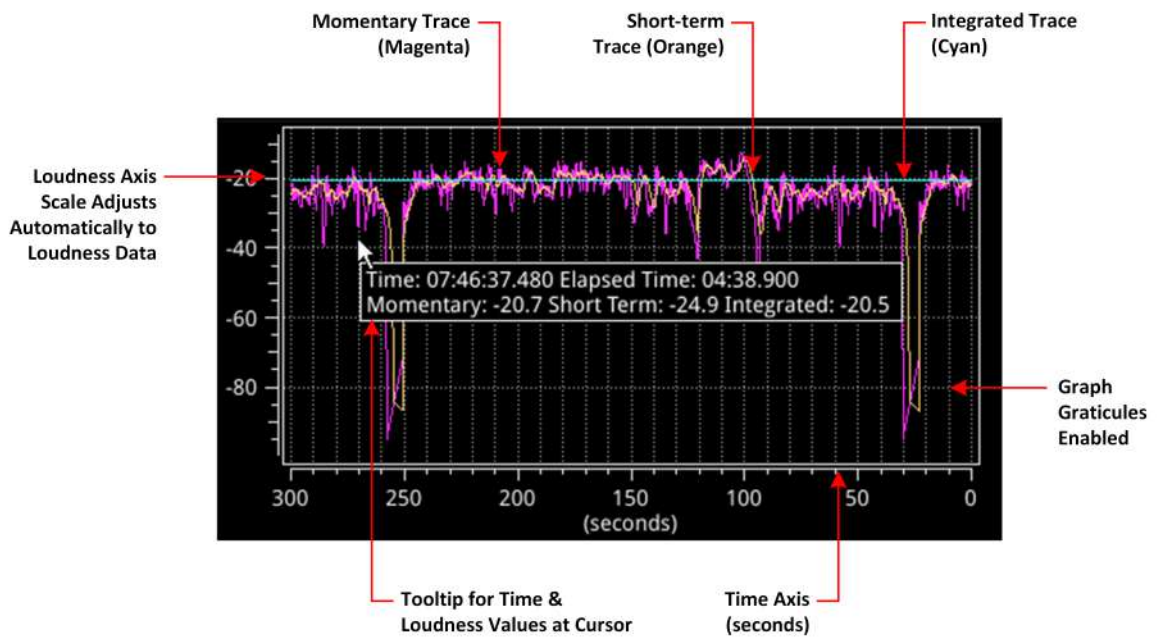

Figure 10-19: Loudness History Graph

Resetting Loudness Values and Errors

The reset controls in the Loudness Options menu enable you to reset the following:

- **True Peak Value:** Resets to the current true peak value at the moment of reset.
- **Loudness Monitoring:** Clears the Loudness History Graph and restarts the loudness monitoring session to start monitoring again from time zero.
- **Errors:** Zeroes any error counts registered by the Momentary, Short-term or Integrated loudness meters.

Managing the Loudness Log Files

The unit automatically starts to record a loudness log when you click **Play** to start the loudness monitoring session.

The unit creates two files for each loudness log as follows:

- A log description text file with a **.txt** extension
- A data file in comma separated value (CSV) format with a **.csv** extension.

Both log files are compressed into a single zip file when the unit saves the logfile to the repository.

The log description text file contains the following content:

- Start Date
- Start Time

- Loudness Mode (LUFS/LKFS/LU)
- List of loudness inputs
- Target and Tolerance configuration
- End Time
- True Peak levels for each loudness input
- Program loudness value
- Highest Momentary Loudness value
- Momentary Error Count
- Highest Short-term Loudness value
- Short-term Error Count
- Highest Integrated Loudness Value
- Integrated Error Count
- Final Loudness Range value.

The data CSV logfile contains the following content:

- Time
- Timecode
- Momentary Loudness value
- Short-term Loudness value
- Integrated Loudness value
- Loudness Range value.

Each time the configured **Log Duration** is reached, or you stop or pause loudness monitoring, the unit saves a Loudness Log to the repository. You can set the Log Duration to a value between five minutes and 24 hours in the options menu, with a default duration of 30 minutes.

Each loudness logfile is an individual, time-stamped, compressed CSV (comma separated value) zip file, saved in the following folder:

qx:/log/loudness

The **Log Lifetime** setting is the period that the unit keeps the loudness logs in its repository. You can set the log lifetime period from one to 30 days in the options menu. Once the configured log lifetime elapses, the unit will delete the loudness logfile.

Retrieving the Loudness Log Files

Use the File Manager to copy the Loudness logfiles to a USB drive, in the same way as with other files. Open the File Manager from Launch menu or insert a USB drive into one of the USB ports.

From the **qx:/** folder, open the **log** folder, then the **loudness** folder. You should see all your loudness logfiles listed with a date- and time-stamp, together with a **.zip** extension. Select the desired files, right-click, then select **Copy from Qx to USB...** from the menu.

You can also delete selected logfiles, if necessary.

For more information on the File Manager, see the section [Managing Files with the File Manager](#).

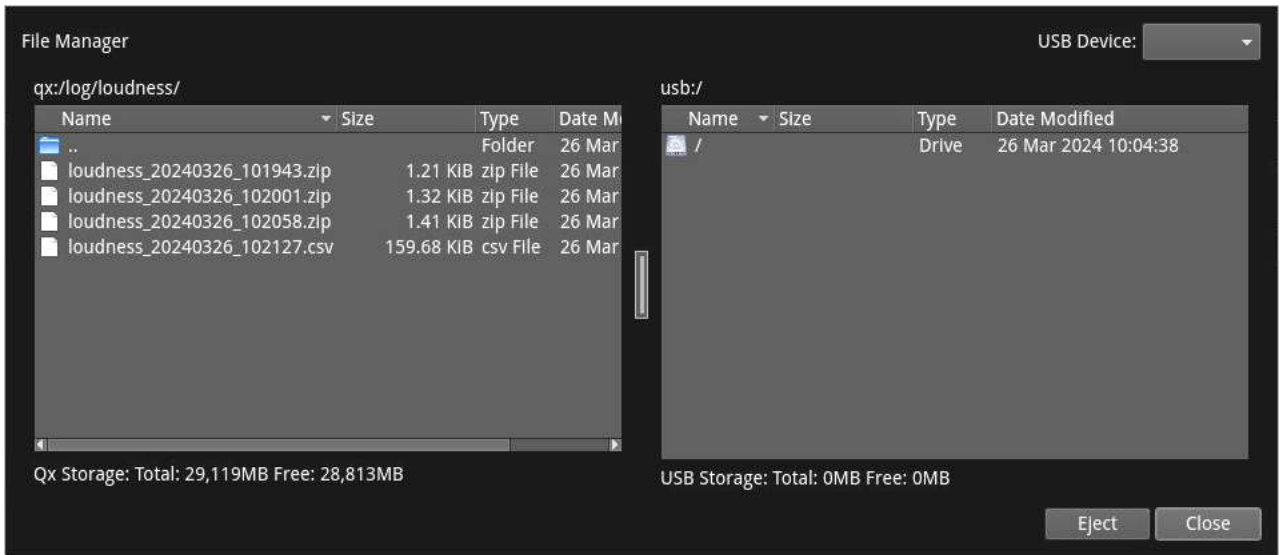

Figure 10-20: Loudness Logfiles Listed in the File Manager

Renaming the Loudness Logfile Base Name

All logfiles are named using the following syntax by default:

loudness_YYYYMMDD_hhmmss.zip



Figure 10-21: Rename Loudness Logfile Base Name

The loudness logs are always date- and time-stamped, however, you can change the default **loudness** base name as required. To do so, select **Rename file...** from the Loudness Options menu to display the rename dialog. Enter a new base name in the field, then click **Ok**. The new base name will be used to name all loudness logfiles from that point forward.

When entering a new base name for the logfile, do not use any of the following special characters as they will be automatically removed from the name on saving:

< > ` * ' | " \$ & , . / : \ ; = ? @, tab or carriage return

Instrument Menu Options

The following menu parameters are available to configure the **Analyzer - Loudness Monitor** Instrument:

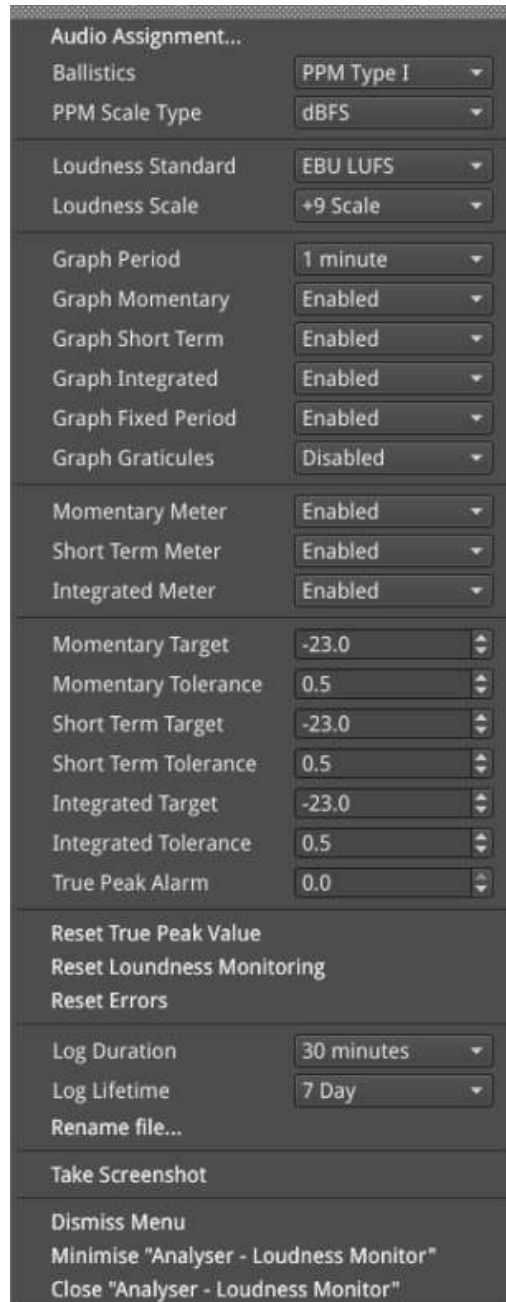

Figure 10-22: Analyzer - Loudness Monitor Menu Options

Table 10-4 : Analyzer - Loudness Monitor Menu Options

Item	Options	Description
Audio Assignment	System Control - opens Audio Assignment dialog	Use this control to open the Audio Assignment dialog to select the audio mode and assign the loudness input channels or Dolby E program, as appropriate. For details, see the table Audio Assignment Modes for Loudness Monitoring .
Audio Meter Ballistics and Scale Settings		
Ballistics	PPM Type I (Default) PPM Type II Vu VuFr Fast	Set the required peak program meter (PPM) ballistic responsiveness setting for the audio meters. PPM Type I emulates the performance of IEC 60268-10 Type I PPM style audio meters typically used by German broadcasters. PPM Type II emulates the performance of IEC 60268-10 Type II PPM style audio meters typically used by UK broadcasters. Vu emulates the performance of IEC 60268-17 Type I PPM style audio meters typically used by US and Australian broadcasters. VuFr emulates the performance of ITU-R Rec BS.645 style audio meters typically used by French broadcasters. Fast provides instantaneous attack ballistics. Note: The Ballistics option is a global setting that applies to all of the unit's audio meters.
PPM Scale Type	dBFS (Default) dBu -18dBFS dBu -20dBFS BBC DIN45406 Nordic N9	Set the desired scale for the loudness audio meters according to your standard operating model. The displayed graticule and audio levels change accordingly to reflect the selected scale. Note: The PPM Scale Type applies only to the audio meters in the Loudness Monitor; the Audio Meters instrument has its own Scale Type setting.
Loudness Settings		
Loudness Standard	EBU LUFS (Default) EBU LU ITU LKFS ITU LU	Select the appropriate loudness standard for loudness monitoring of your audio track or program. You can switch between ITU and EBU standards without losing your customized settings.
Loudness Scale	+9 Scale (Default) +18 Scale	The +9 and +18 scales are defined in EBU Tech 3341-2016 and have been adopted by the ITU. The scale ranges are as follows for EBU: +9 Scale: -18.0 LU to +9.0 LU (-41.0 LUFS to -14.0 LUFS) +18 Scale: -36.0 LU to +18.0 LU (-59.0 LUFS to -5.0 LUFS) The scale ranges are as follows for ITU: +9 Scale: -18.0 LU to +9.0 LU (-42.0 LUFS to -15.0 LUFS) +18 Scale: -36.0 LU to +18.0 LU (-60.0 LUFS to -6.0 LUFS) See Figure 10-23 for a comparison of these scales.
Loudness History Graph Settings		

Item	Options	Description
Graph Period	1 minute(Default) 2 minutes 5 minutes 10 minutes	Define the time period over which the History Graph displays loudness data. The horizontal time scale adjusts automatically to the selected period.
Graph Momentary	Enabled (Default) Disabled	When enabled, the unit plots the Momentary loudness trace in the Loudness History Graph. You can switch off the display of the Momentary loudness trace if desired. You can display the Momentary graph even if the Momentary loudness meter is disabled.
Graph Short Term	Enabled (Default) Disabled	When enabled, the unit plots the Short-term loudness trace in the Loudness History Graph. You can switch off the display of the Short-term loudness trace if desired. You can display the Short-term graph even if the Short-term loudness meter is disabled.
Graph Integrated	Enabled (Default) Disabled	When enabled, the unit plots the Integrated loudness trace in the Loudness History Graph. You can switch off the display of the Integrated loudness trace if desired. You can display the Integrated graph even if the Integrated loudness meter is disabled.
Graph Fixed Period	Enabled (Default) Disabled	When enabled, the x-axis is set to the static value set in the Graph Period option and does not change dynamically. When disabled, the x-axis scale is dynamic up to a maximum period of 2 minutes (120 seconds), after which it is fixed.
Graph Graticules	Disabled (Default) Enabled	When enabled, displays gridlines in the background of the graph.
Loudness Meter Activity		
Momentary Meter	Enabled (Default) Disabled	When disabled, the Loudness Monitor will not display momentary loudness values or errors, however, the data is still recorded in the loudness log.
Short Term Meter	Enabled (Default) Disabled	When disabled, the Loudness Monitor will not display short-term loudness values or errors, however, the data is still recorded in the loudness log.
Integrated Meter	Enabled (Default) Disabled	When disabled, the Loudness Monitor will not display integrated loudness values or errors, however, the data is still recorded in the loudness log.
Loudness Targets, Tolerances and Alarm		
Momentary Target	Range: - 41 to -14 Default: -23	Set the maximum acceptable Momentary loudness level for the monitored track or program. This represents the green section of the meter and signal.
Momentary Tolerance	Range: 0.0 to 10.0 Default: 0.5	When set to a value above 0.0, the Momentary tolerance is displayed as the yellow background of the Momentary Loudness meter. When the monitored momentary loudness is within the tolerance, the level color changes to yellow. A tolerance level provides an acceptable buffer to accommodate for measurement errors.

Item	Options	Description
		If the Momentary tolerance is set to 0.0 then the tolerance / target feature is disabled so that the meter background is completely green and no errors are displayed.
Short Term Target	Range: – 41 to –14 Default: –23	Set the maximum acceptable Short-term loudness level for the monitored track or program. This represents the green section of the meter and signal.
Short Term Tol-erance	Range: 0.0 to 10.0 Default: 0.5	When set to a value above 0.0, the Short-term tolerance is displayed as the yellow background of the Short-term Loudness meter. When the monitored short-term loudness is within the tolerance, the level color changes to yellow. A tolerance level provides an acceptable buffer to accommodate for measurement errors. If the Short-term tolerance is set to 0.0 then the tolerance / target feature is disabled so that the meter background is completely green and no errors are displayed.
Integrated Target	Range: – 41 to –14 Default: –23	Set the maximum acceptable Integrated loudness level for the monitored track or program. This represents the green section of the meter and signal.
Integrated Tol-erance	Range: 0.0 to 10.0 Default: 0.5	When set to a value above 0.0, the Integrated tolerance is displayed as the yellow background of the Integrated Loudness meter. When the monitored integrated loudness is within the tolerance, the level color changes to yellow. A tolerance level provides an acceptable buffer to accommodate for measurement errors.
True Peak Alarm	Range: 0 to –99 Default: 0	Set the threshold above which the unit generates errors for the loudness True Peak.
Reset Controls		
Reset True Peak Value	System Control	Resets to the current True Peak value at the moment of reset.
Reset Loudness Monitoring	System Control	Resets both the Loudness History Graph and the loudness logs. The loudness monitoring session restarts from time zero.
Reset Errors	System Control	Resets all error counts from the active loudness meters to zero. This control does not reset the loudness logs.
Loudness Log Settings		
Log Duration	5 minutes 15 minutes 30 minutes (Default) 1 hour 2 hours 3 hours 6 hours 12 hours 24 hours	Set the duration of each loudness logfile. When the Log Duration is met during a monitoring session, the unit saves the logfile to the repository with the current date and time-stamp.
Log Lifetime	1 day	Set the retention period for loudness logfiles in the unit's

Item	Options	Description
	7 days (Default) 14 days 30 days	repository. On expiry of the Log Lifetime period, the unit deletes the logfile to free-up space in the repository.
Rename File...	System Control - Opens file renaming dialog	Use this dialog to change the loudness logfile base-name from loudness to a different string.

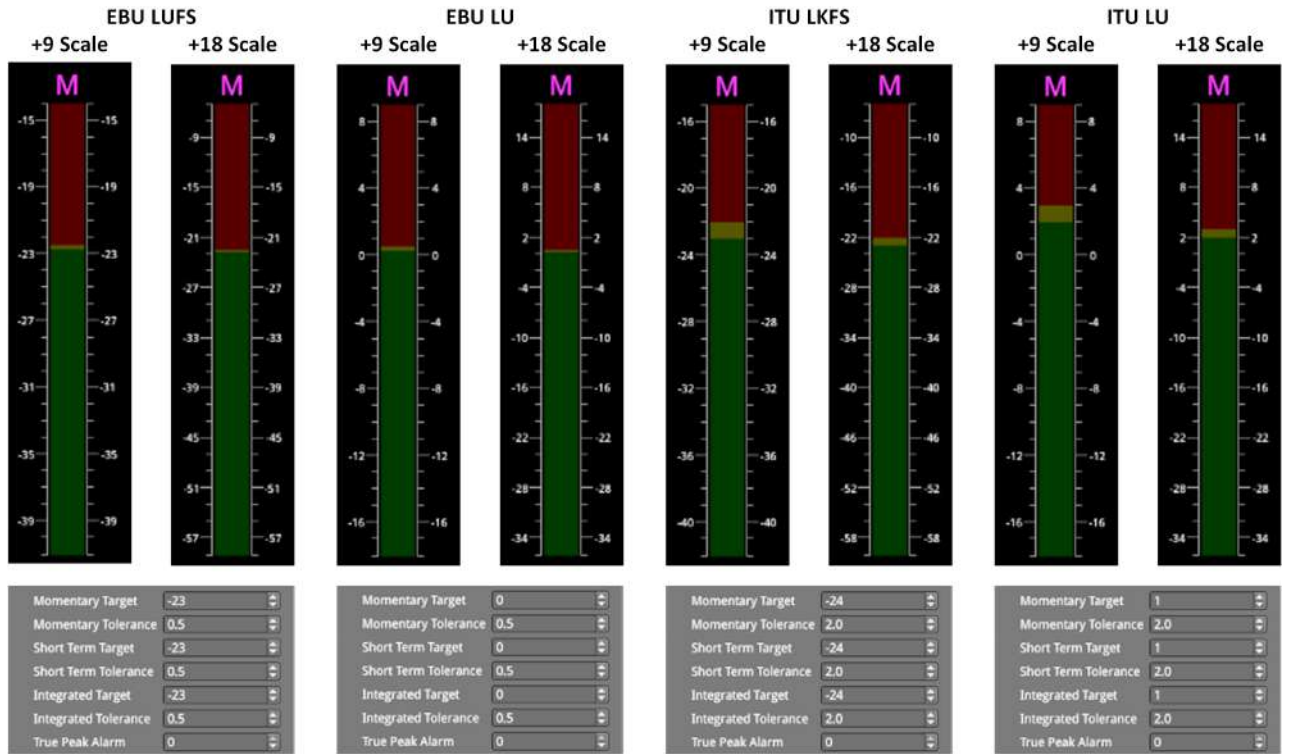

Figure 10-23: Loudness Standard Scales for Momentary Meter & Default Target/Tolerance Settings for All Meters

Analyzer - Dolby Metadata



Requires Option(s):	PHQXLO-DOLBY
---------------------	--------------

Overview

The **Analyzer - Dolby Metadata** instrument displays the Dolby E™ metadata present in a selected audio stream. It also enables you to check the correct timing of Dolby E packets in the audio signal at all stages in an IP (ST 2022-6 / ST 2110) or SDI broadcast chain. You can check whether the Dolby E is created correctly and transferred transparently through the broadcast chain unaffected by network equipment such as routers, switchers, satellite links, etc.

You can choose to monitor the Dolby® audio from any of the ST 2022-6 IP, ST 2110 IP, or optional SDI input embedded audio pairs / channels; or the AES input.

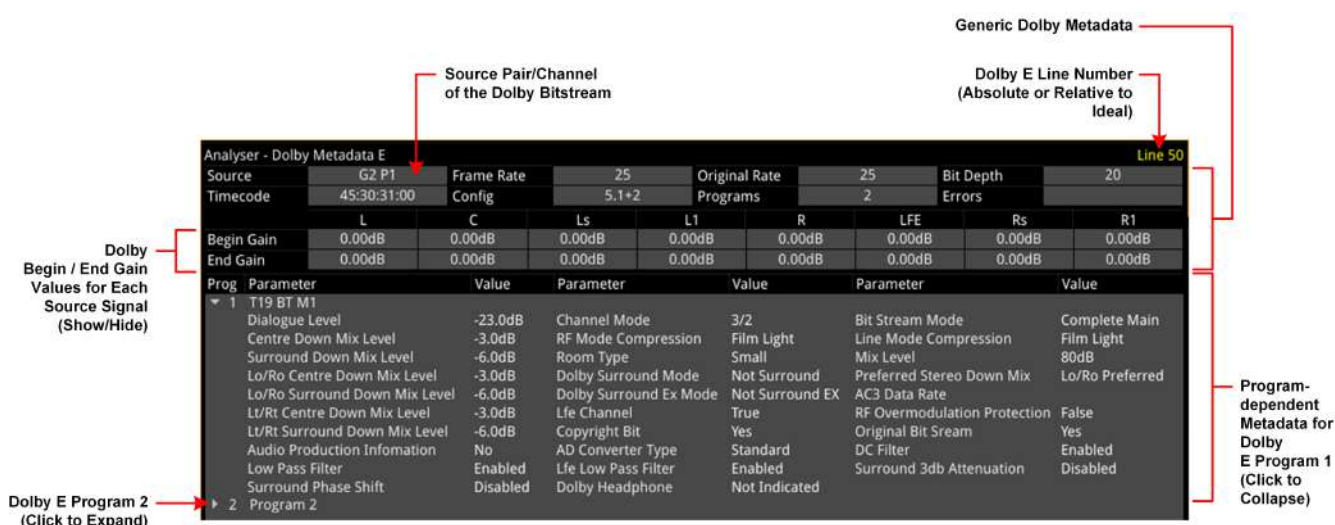

Figure 10-24: Analyzer - Dolby Metadata E Instrument (ST 2022-6 IP and optional SDI Input)

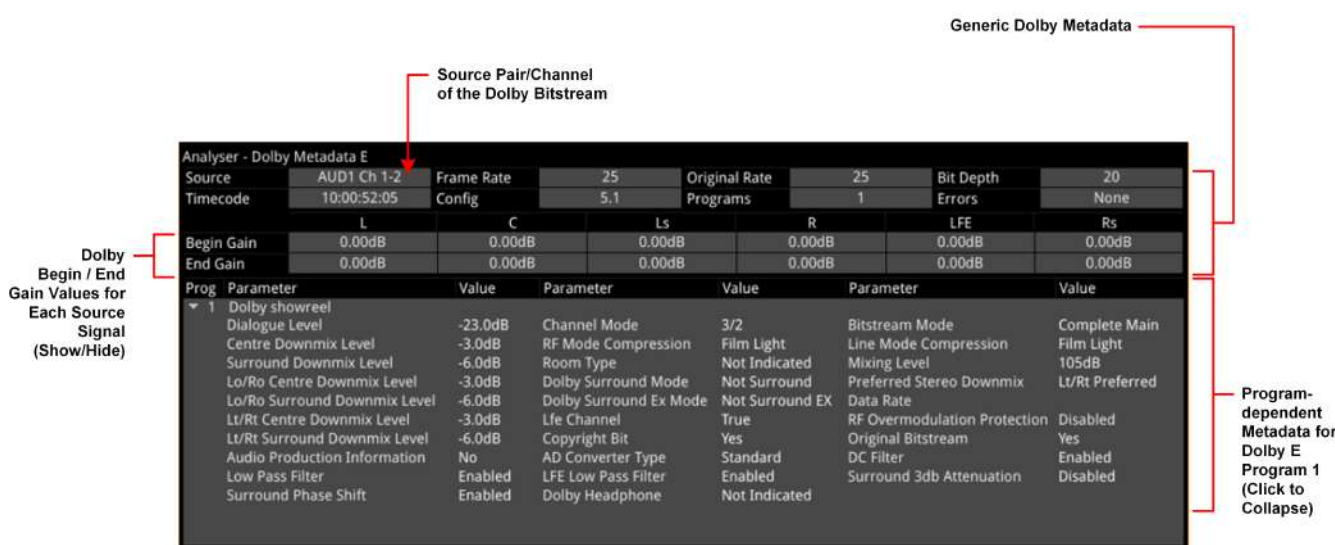

Figure 10-25: Analyzer - Dolby Metadata E Instrument (ST 2110 IP Input)

The Dolby E Line Number, displayed in the top-right of the window (for ST 2022-6 IP and optional SDI input), may be displayed in different colors as follows:

- White: Line number within ideal range.
- Yellow: Line number within allowable range.
- Red: Line number outside the allowable range for the Dolby start line.

To expand or collapse the display of metadata for a program, click on the triangular icon next to the program number or in any column on the program's line.

For more information, refer to the Dolby reference documentation.

Dolby E and Dolby ED2 digital audio standards can be transported as audio data over a SMPTE 337M AES carrier with a 48 kHz sample rate. These standards can be used to transport mono, stereo, Dolby 5.1 and Dolby 7.1 audio programs.

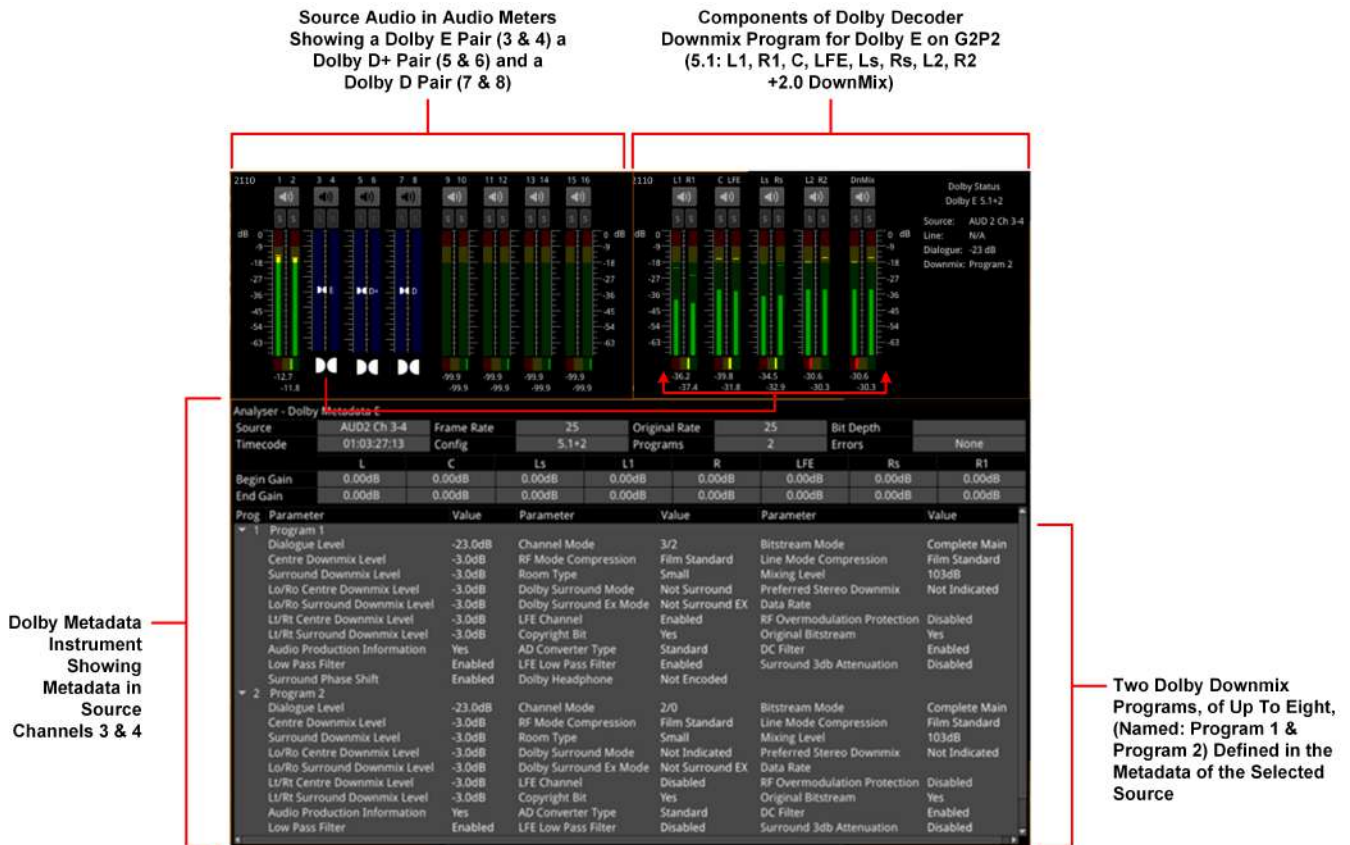

Figure 10-26: Audio Meters, Dolby Decoder and Dolby Metadata Instruments (ST 2110 Input)

About Dolby Metadata

Dolby E is an audio technology that carries metadata together with the audio bitstream. The metadata describes the encoded audio and includes information to control downstream encoders and decoders. The encoded audio and metadata are usually transmitted together as a bitstream on a pair of standard digital audio channels (for example, AES3).

Dolby E includes metadata parameters required for the transmission encoder. Metadata can be added during program creation or mastering and then carried through the broadcast transmission.

Dolby E

Dolby E is a production audio encoding and decoding technology, developed by Dolby Laboratories, that allows up to eight channels of audio (mono, stereo, 5.1 or 7.1) for a primary program (Program 1) and optional ancillary programs. These eight channels are compressed (low loss) into a digital stream that can be transferred between compatible devices and stored on a standard stereo pair of audio tracks.

This format is based on video frames and allows switching and further processing and/or compression.

Dolby ED2

Dolby ED2 is an extension to Dolby E, designed with future audio technologies in mind and is backward compatible with Dolby E.

Instrument Menu Options

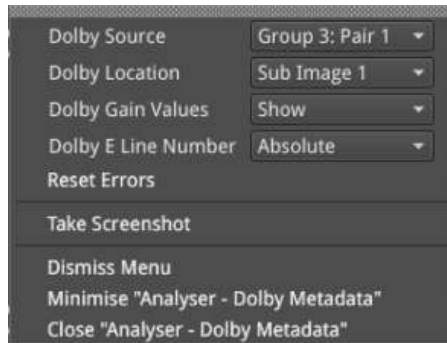

Figure 10-27: Analyzer - Dolby Metadata Options Menu (ST 2022-6 IP / Optional SDI Input)

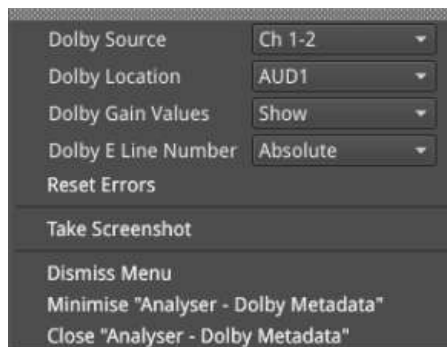

Figure 10-28: Analyzer - Dolby Metadata Options Menu (ST 2110 IP Input)

The following menu options are available for configuring the **Analyzer - Dolby Metadata** Instrument:

Note: The following controls are duplicated in the Audio Meters instrument. The **Dolby Source** selection affects the Dolby Decoder and consequently also affects the Audio Meters instrument.

Table 10-5 : Analyzer - Dolby Metadata Menu Options

Item	Options	Description
Dolby Source (ST 2022-6 IP and Optional SDI Input)	Group 1: Pair 1 Group 1: Pair 2 Group 2: Pair 1 Group 2: Pair 2 Group 3: Pair 1 Group 3: Pair 2 Group 4: Pair 1 Group 4: Pair 2 Group 5: Pair 1 Group 5: Pair 2 Group 6: Pair 1 Group 6: Pair 2 Group 7: Pair 1 Group 7: Pair 2	Select the source for each audio pair configured as the Dolby source.

Item	Options	Description
	Group 8: Pair 1 Group 8: Pair 2	
Dolby Source (ST 2110 IP Input)	None Ch 1-2 Ch 3-4 Ch 5-6 Ch 7-8 Ch 9-10 ... Ch 31-32 (Audio Flows set to 4x 32) Ch 63-64 (Audio Flows set to 2x 64) Ch 79-80 (Audio Flows set to 1x 80)	Select the source for each audio channel pair configured as the Dolby source.
Dolby Source (When AES Selected as Dolby Location)	None AES 1 AES 2 AES 3 AES 4	Select the source for each AES audio input configured as the Dolby source
Dolby Location (ST 2022-6 IP and Optional SDI Input)	Sub Image 1 Sub Image 2 Sub Image 3 Sub Image 4 AES	Select the appropriate sub-image or the AES input as the location of the Dolby metadata.
Dolby Location (ST 2110 IP Input)	With Audio Flows set to 1x 80 Channel: AUD1 AES With Audio Flows set to 2x 64 Channel: AUD1 AUD2 AES With Audio Flows set to 4x 32 Channel: AUD1 AUD2 AUD3 AUD4 AES	Select the appropriate flow (either 2110-30 or -31) or the AES input as the location of the Dolby metadata.
Dolby Gain Values	Show (Default) Hide	Choose whether to display Dolby gain values in the Metadata instrument for each of the Dolby channels.
Dolby E Line Number (ST 2022-6 IP and Optional SDI Input)	Absolute (Default) Relative to Ideal	Select whether to display the Dolby E timing line number relative to the ideal for the selected standard, or as an absolute line number.
Reset Errors	Control	Reset the error counter to zero.

Dolby Program Metadata Display

Generic Information

The following table provides an overview of the generic section in the first two rows of the **Analyzer - Dolby Metadata** instrument.

Table 10-6 : Generic Parameters

Parameter	Displayed Values	Description
Frame Rate (fps)	23.98 24 25 29.97 30	Indicates the frame rate, in frames per second, of the video reference signal to which the device producing the metadata stream is locked.
Original Rate (fps)	23.98 24 25 29.97 30	Indicates the frame rate, in frames per second, of the original source.
Bit Depth	16 20 24	The number of bits per word used in the Dolby E Frame.
Timecode	hh:mm:ss:ff	Displays the SMPTE timecode associated with the Dolby E frame in the format: hours:minutes:seconds:frames
Config	5.1 + 2 5.1 + 2 x 1 4 + 4 4 + 2 x 2 Etc.	Program configuration displays the grouping of audio channels in a Dolby E bitstream. Up to eight channels can be grouped together in individual programs, where each program contains its own metadata. For full details, see the <i>Dolby Metadata Guide</i> .
Programs	1 to 8	Displays the number of Programs in the source Dolby E bitstream. The number of programs ranges from a single program to eight individual programs on a single Dolby E stream. Each program is discrete, with its own metadata in the Dolby E stream.
Errors	Error count	Count of the number of CRC errors found in the audio segments, the metadata segments and the synch/framing segments. Can be reset to zero using the Reset Errors control in the instrument options menu.

Dolby Gain Metadata

The Gain section of the **Analyzer - Dolby Metadata** instrument displays the beginning and end gain settings for each channel in the Dolby E program.

You can choose to show or hide the Gain section to provide additional screen real-estate for viewing the program metadata parameters.

Dolby Program Metadata

Program metadata is created as part of Dolby authoring process. The **Analyzer - Dolby Metadata** instrument displays the following metadata from the Dolby E Program:

Table 10-7 : Dolby Program Metadata - Displayed Parameters

Dolby Metadata Parameter	Displayed Options	Description
Column 1 Metadata		
Dialogue Level	-1 to -31 dB	The long term average level of dialogue within a presentation.
Center Downmix Level	-3 dB -4.5 dB -6 dB	The weighting factor applied to the Center channel during a downmix to stereo 2.0 using Legacy Downmix Metadata.
Surround Downmix Level	-3 dB -6 dB -999 dB	The weighting factor applied to the Surround channels during a downmix to stereo 2.0 using Legacy Downmix Metadata.
Lo/Ro Center Downmix Level	+3 dB +1.5 dB 0.0 dB -1.5 dB -3.0 dB -4.5 dB -6.0 dB -999 dB	The weighting factor applied to the Center channel when downmixing to Left Only / Right Only (Lo/Ro) stereo 2.0 using extended Metadata.
Lo/Ro Surround Downmix Level	-1.5 dB -3.0 dB -4.5 dB -6.0 dB -999 dB	The weighting factor applied to the Surround channels when downmixing to Left Only / Right Only (Lo/Ro) stereo 2.0 using extended Metadata.
Lt/Rt Center Downmix Level	+3 dB +1.5 dB 0.0 dB -1.5 dB -3.0 dB -4.5 dB -6.0 dB -999 dB	The weighting factor applied to the Center channel when downmixing to Left Total / Right Total (Lt/Rt) stereo 2.0 using extended Metadata.
Lt/Rt Surround Downmix Level	-1.5 dB -3.0 dB -4.5 dB -6.0 dB -999 dB	The weighting factor applied to the Surround channels when downmixing to Left Total / Right Total (Lt/Rt) stereo 2.0 using extended Metadata.
Audio Production Information	Yes No	Indicates whether the bitstream contains information about the audio production environment used in making the program.
Lowpass Filter	Enabled/Disabled	Indicates whether a lowpass filter is applied to the main input channels of a Dolby encoder before encoding. The filter removes high frequency signals that are not encoded. At suitable data rates this filter operates above 20 kHz. In all cases it prevents aliasing on decoding and is usually enabled.
Surround Phase Shift	Enabled/Disabled	The Surround Channel 90-Degree Phase-Shift feature is applied when creating an Lt/Rt stereo 2.0 downmix.
Column 2 Metadata		

Dolby Metadata Parameter	Displayed Options	Description
Channel Mode	1+1 1/0 Mono 2/0 Stereo 3/0 2/1 3/1 2/2 3/2	Defines the channel configuration for the Program.
RF ModeCompression	Film Light Film Standard Music Light Music Standard Speech None	An Operational Mode / Dynamic Compression Mode used by consumer and professional decoder products.
Room Type	Not Indicated Large Small	Describes the equalization used during the final mixing session.
Dolby Surround Mode	Not Dolby Surround Dolby Surround Not Indicated	This parameter is used to identify whether the bitstream contains information that was encoded in Dolby Surround. If this is true, after Dolby Digital decoding, the bitstream may be decoded using Dolby Pro Logic.
Dolby Surround Ex Mode	Not Indicated Not Surround EX Surround EX	This parameter is used to identify the encoded audio as material encoded in Surround EX™
Lfe Channel	Enabled Disabled	The status of the LFE Channel parameter indicates to a Dolby Digital encoder whether an LFE Channel is present within the bitstream. Channel mode determines whether the LFE Channel parameter can be set. You must have at least three channels to be able to add an LFE channel.
Copyright Bit	Yes No	This parameter indicates whether the encoded Dolby Digital bitstream is copyright protected.
AD Converter Type	Standard HDCD	Allows audio that has passed through a particular A/D conversion stage to be marked as such, so that a decoder may apply the complementary D/A process.
Lfe Lowpass Filter	Enabled Disabled	This parameter determines whether a lowpass filter is applied to the LFE channel. It is ignored if the LFE channel is disabled.
Dolby Headphone	Not Indicated Not Dolby Encoded Dolby Encoded Reserved	Indicates whether the program has been encoded for use with Dolby Headphones.
Column 3 Metadata		
Bitstream Mode	Complete Main Main M&E Assc Visual Imp Assc Hear Imp	Indicates the type of audio service that the bitstream contains. Complete Main is the standard mode of operation and contains a complete audio program including

Dolby Metadata Parameter	Displayed Options	Description
	Assc Dialogue Assc Commentary Assc Emergency Assc Voice Over Main Sv Karaoke	dialog, music, and effects. Associated services may also be included in the bitstream.
Line Mode Compression	Film Light Film Standard Music Light Music Standard Speech None	Indicates which Dynamic Range Control Profile was selected during the mastering process.
Mixing Level	80 dB to 111 dB in 1 dB increments	Indicates the peak sound pressure level (SPL) used during the final mixing session at the studio or on the dubbing stage.
Preferred Stereo Down Mix	Not Indicated Lt/Rt Downmix preferred Lo/Ro Downmix preferred Reserved	This parameter allows the producer to select either the Lt/Rt or the Lo/Ro downmix in a consumer decoder that has stereo outputs. Consumer receivers are able to override this selection, but this parameter provides the opportunity for a 5.1-channel soundtrack to play in Lo/Ro mode without user intervention. This is especially useful on music material.
Data Rate	32 kbps 40 kbps 56 kbps 64 kbps 80 kbps 96 kbps 112 kbps 128 kbps 160 kbps 192 kbps 224 kbps 256 kbps 320 kbps 384 kbps 448 kbps 512 kbps 576 kbps 640 kbps	Indicates the data rate that should be used to encode the transmitted bitstream associated with the specified program.
RF Over-modulation Protection	Enabled Disabled	Determines whether an RF pre-emphasis filter is used in the overload protection algorithm to prevent RF over-modulation in set-top box decoders. Usually disabled but if enabled, displayed in yellow font.
Original Bitstream	Yes No	Sets the value of a single bit in the Dolby bitstream to indicate whether the bitstream is the master version (Yes) or a copy (No).
DC Filter:	Enabled Disabled	This parameter determines whether a DC-blocking 3 Hz highpass filter is applied to the main input channels of the audio encoder.

Dolby Metadata Parameter	Displayed Options	Description
Surround 3dB Attenuation	Enabled Disabled	This parameter determines whether the Surround channel(s) are to be attenuated by 3 dB before encoding. The attenuation actually takes place inside the Dolby Audio encoder.

Table 10-8 : Dolby Program Configuration Settings

Dolby Program	Program Count	Channel Count	Program Configuration
0	2	8	5.1+2
1	3	8	5.1+2x1
2	2	8	4+4
3	3	8	4+2+2
4	4	8	4+2+2x1
5	5	8	4+4x1
6	4	8	2+2+2+2
7	5	8	2+2+2+2x1
8	6	8	2+2+4x1
9	7	8	2+5x1
10	8	8	6x1
11	1	6	5.1
12	2	6	4+2
13	3	6	4+2x1
14	3	6	2+2+2
15	4	6	2+2+2x1
16	5	6	2+2x4
17	6	6	6x1
18	1	4	4
19	2	4	2+2
20	3	4	2+2x1
21	4	4	4x1
22	1	8	7.1
23	1	8	7.1

Data Analysis Instruments

This chapter describes the suite of data analysis Instruments and includes the following sections:

- [Analyzer - Dataview](#)
- [Analyzer - Ancillary Status](#)
- [Analyzer - Ancillary Inspector](#)



Overview

The **Analyzer - Dataview** instrument displays the raw data present in the signal, for the following inputs:

- ST 2022-6 IP
- Optional SD-SDI: 270M (Factory-fitted option)
- Optional HD-SDI: 1.5G, 3G, 6G, 12G (Factory-fitted option)

Note: For the analysis of ST 2022-6 input, you first need to select an ST 2022-6 IP flow in the [IP Receive - Flows](#) instrument.

You can observe the data in hexadecimal, decimal, or binary formats, and each data word has a sample and line coordinate. The instrument displays the entire video frame complete with active video, TRS words, and blanking information. Changing the window size changes the amount of data displayed.

Note: The Analyzer - Dataview Instrument is not currently available for the analysis of ST 2110 IP input data flows.

For 6G-SDI and 12G-SDI video standards, pre-imposed sync bit correction is provided with the SDI stress testing software option: **PHQXLO-SDI-STRESS**.

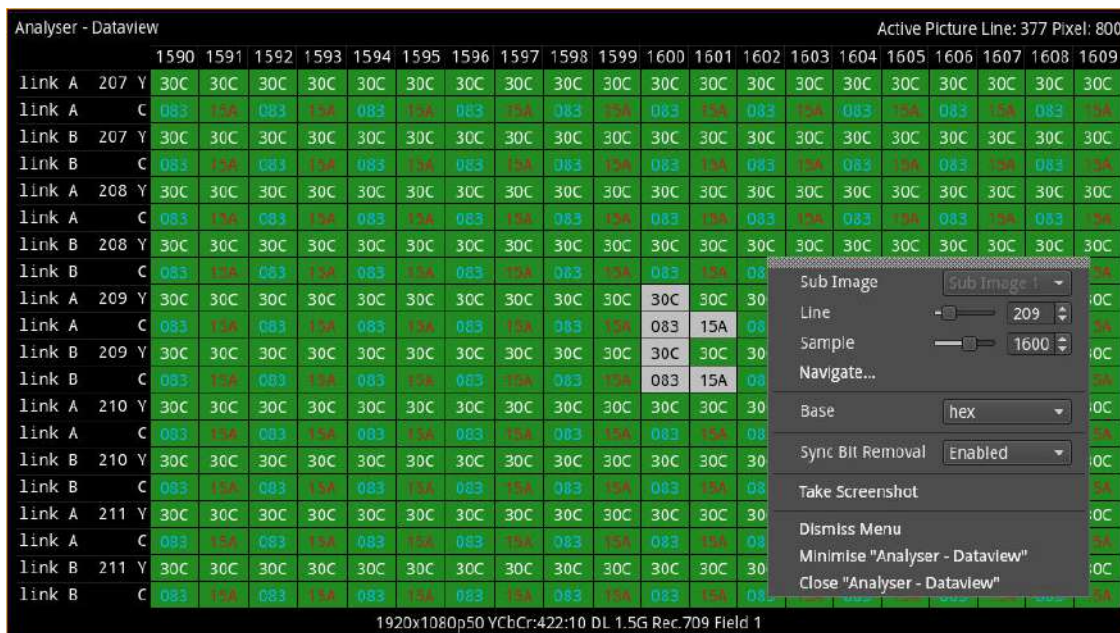

Figure 11-1: Analyzer - Dataview Instrument

Note: If the Dataview instrument is active but the unit is configured to analyze an ST 2110 IP input, you will see the following warning message displayed in the window: **Invalid Input**.

To resolve, make sure that the input source is **ST 2022-6** or **SDI** as required, with the analyzer input set to **IP** or **SDI**, respectively.

Data is presented with a color-coding for both text and background:

- Foreground color indicates video sample type: Y (white), Cb (blue), Cr (red)
- Background color indicates data type: Timing reference signal (TRS) words (blue), Blanking (black), Active picture (green).

You can quickly navigate the Dataview window using sample and line selection in the Cursor tool or using the Navigate keypad, see [Figure 11-2](#).

Both tools are dynamically linked to an enabled Picture Cursor in the Waveform and Picture instruments.

The Cursor tool provides transport line and sample sliders to move around the dataview, at the same time as giving the corresponding Active Picture line and pixel values.

The Navigate keypad allows you to enter the desired coordinates, and provides buttons for quick navigation to key locations: first and last samples or lines, end of active video (EAV) and start of active video (SAV) TRS words, active picture (AP) furthest - left, right, top, and bottom positions.



Figure 11-2: Dataview Navigation Keypad

Instrument Menu Options

The following table lists the configurable parameters in the Analyzer - Dataview instrument submenu:

Table 11-1 : Analyzer - Dataview Options

Item	Options	Description
Sub Image	Sub Image 1 (Default) Sub Image 2 Sub Image 3 Sub Image 4	When enabled, select the sub image for data analysis (standard dependent).

Item	Options	Description
Line	System Control	1 to Total number of Lines for current standard
Sample	System Control	1 to Total number of Pixels for current standard.
Navigate...	System Control	Displays the Dataview navigation keypad.
Base	Hex (default) Decimal Binary	Change the base in which to view the data grid.
Sync Bit Removal Note: Requires the Advanced SDI Stress Toolset (PHQXLO-SDI-STRESS)	Enabled (default) Disabled	For 6G-SDI and 12G-SDI video standards, use to view the data stream before sync bit removal or after sync bit removal. Enabling Sync Bit Removal reverts affected bits to the original value they held prior to sync bit insertion. You can observe this reversion in the TRS and ADF words.

Note: Sync Bit Removal applies only to 6G-SDI and 12G-SDI video standards, where the inclusion of a sync bit is defined in the SMPTE standards. Signals not containing sync bits are unaffected.

If you hover the cursor over a data cell in the grid, the unit displays a tooltip as shown in [Figure 11-3](#).

000	000	2AC	200	200	200	200
000	000	200	07C	161	28A	36F
000	000	200	200	200	200	200
000	000	200	07C	161	28A	36F
000	000	200	200	200	200	200
000	000	200	07C	161	28A	36F
000	000	200	200	200	200	200
000	000	200	07C	161	28A	36F
000	000	200	200	200	200	200
000	000	200	07C	161	28A	36F

Figure 11-3: Analyzer - Dataview Instrument Showing Cursor Tooltip

The coordinates displayed in the Dataview tooltip define the sample and line number pair in the format: **(sample number, line number)**. The tooltip also displays additional information for each cell over which the mouse pointer is held: whether it is the Y-, Cb, Cr- or Alpha-component, etc. This defines the content of the data cell below the cursor.

The highlighted cells (light-gray background) are the samples that contribute to the definition of a single pixel. You can then pinpoint that specific pixel using the cursor function of the **Picture** instrument. Either left-click in the Picture window or specify the coordinates of the pixel in the options menu of the Picture instrument. Alternatively, you can also specify the Line Number and Sample Number using the controls in the Dataview options menu. These functions map the line and sample number pairs to the line and pixel number pairs of the active picture.

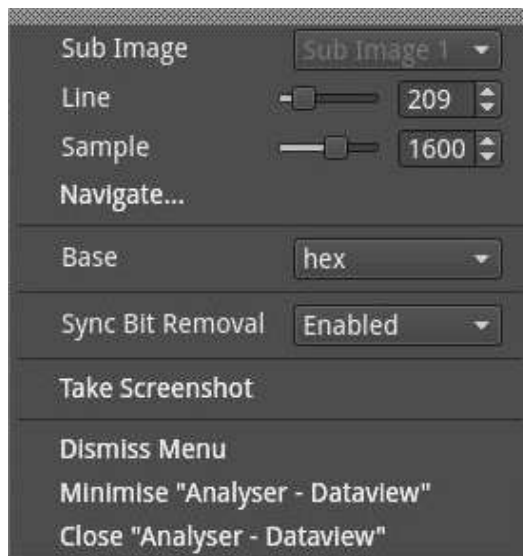

Figure 11-4: Analyzer - Dataview Options Menu



Overview

The **Analyzer - Ancillary Status** instrument provides a sophisticated, real-time display which analyzes the ancillary data present in the signal. UHDTV has a new set of rules for carrying this data and a clear graphical representation is required to establish compliance. Color-coded signal conditions - present, lost, and error are all available. Additional data is displayed as you resize the instrument.

In addition to the option of a combined view, tabs are provided for separate Grid or List views of the ancillary data.

Ancillary Status - Grid		List View	
S353 MPEG Recoding	S305 SDTI	S348 HD-SDTI	S427 Link Encryption
S352 Payload ID	S2016-3 AFD	S2016-4 PAN	S2010 ANSI/SCTE
S2031 DVB/SCTE	S2056 MPEG TS	S2068 3D Packing	S2064 Lip Sync
ITU-R BT.1685	OP47 Caption	OP47 VBI/WST	ARIB-TR-B29
RDD18 Metadata	RP214 KLV Metadata	RP223 UMID/ID	S2020 Audio
S2051 Two Frame	RDD8 WSS	RP215 Film Codes	S12M-2 V-TCODE
EIA-708 Caption	EIA-608 Caption	RP207 Program	S334-1 Data
RP208 VBI Data	Mark Deleted	S299-2 3G Audio	S299-1 HD Audio
S272 SD Audio	S315 Camera Pos	RP165 EDH	S12-3 HFR TCODE
S2103 Generic Time	S2108-1 HDR/WCG		

Figure 11-5: Analyzer - Ancillary Status

The Grid view provides a high-level overview of the packets present in the ancillary data.

In the List View tab, you can expand the headings, to allow a granular drill-down of discovered ancillary packets – providing information on presence, checksum, parity, and data block number (DBN). You can select packets in this window for analysis by the **Analyzer – Ancillary Inspector**.

Color-coding of displayed data provides further health information at a glance:

- White - Indicates ANC packets present and correct
- Red - Indicates ANC packets present but in error
- Yellow - indicates ANC packets present and correct but there has been a previous error.

Instrument Menu Options

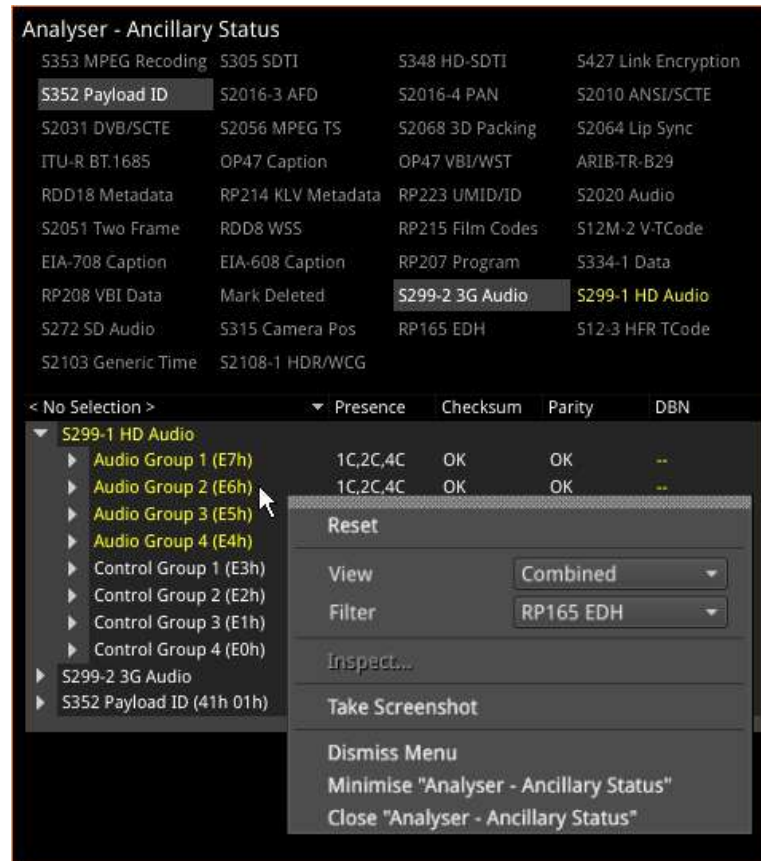

Figure 11-6: Analyzer - Ancillary Status Menu Options

From the **Analyzer - Ancillary Status** instrument submenu, accessible in all views, you can reset the ancillary status analysis, inspect selected packets and set configuration options as follows:

Table 11-2 : Analyzer - Ancillary Status Menu Options

Item	Options	Description
Reset	N/A	Select to reset ancillary status analysis (accessible in all views).
View	Tab View Combined	The combined view provides both a high-level overview grid at the top and an expandable list view below, all in a single window, as shown in the following screen:
Filter	None Ancillary Packet Type	Change the ancillary packet type being filtered by simply selecting a different packet type from the Grid. See the following table for a list of available ancillary data identifiers.
Inspect	Selected packets in Analyzer.	Note: If a packet type is not selected in the List view, the Inspect... option will be unavailable. Enables you to select packets from the list and then initiate ancillary inspection, see Table 11-3 for a list of ancillary data IDs. For more information on ANC inspection, see the section Analyzer - Ancillary Inspector . Select Inspect... to send the inspection request over to the Analyzer - Ancillary Inspector Instrument. If the

Item	Options	Description
		<p>Analyzer - Ancillary Inspector is not currently open, the request opens the instrument. The inspection request is loaded into the Identifier field of the Inspector instrument and, depending on the trigger setting, reacts as follows:</p> <p>None - the request is loaded, but not acted upon</p> <p>Single Shot - the ANC Inspector searches for the packet type and displays the result once a matching packet is detected. (The trigger is then set back to None.)</p> <p>Continuous - the ANC Inspector continuously searches for the selected packet type and refreshes the displayed results each time it detects a matching packet type.</p>

Table 11-3 : List of Ancillary Status Grid Identifiers

Ancillary Status Grid Identifier	Description
S353 MPEG Recoding	MPEG-2 Recoding Information
S305 SDTI	SDTI transport in active frame space
S348 HD SDTI	HD-SDTI Transport in active frame space
S427 Link Encryption	Link encryption for 1.5 Gb/s Serial Digital Interface
S352 Payload ID	Payload identification, HANC space
S4S2016-3 AFD	AFD and Bar data
S2016-4 PAN	Pan-scan data
S2010 ANSI/SCTE	ANSI/SCTE 104 messages
S2031 DVB/SCTE	DVB/SCTE VBI data
S2056 MPEG TS	MPEG TS packets in VANC
S2068 3D Packing	Stereoscopic 3D frame compatible packing and signaling
S2064 Lip Sync	Lip sync data as specified by ST 2064-1 or ST 2064-2
ITU-RBT.1685	Structure of inter-station control data conveyed by ancillary data packets
OP47 Caption	OP47/RDD8 Subtitling distribution packet (SDP)
OP47 VBI/WST	OP47/RDD8 Transport of VBI and/or WST data in a VANC Multipacket
ARIB-TR-B29	Metadata to monitor errors of audio and video signals on a broadcasting chain
RDD18 Metadata	Acquisition metadata sets for video camera parameters
RP214 KLV Metadata	KLV encoded metadata transport
RP223 UMID/ID	Packing UMID and Program Identification Label data into SMPTE 291M Ancillary Data Packets
S2020 Audio	Compressed audio metadata
S2051 Two Frame	Two frame marker in HANC
RDD8 WSS	Wide-screen signaling data
RP215 Film Codes	Film codes in VANC space

Ancillary Status Grid Identifier	Description
S12M-2 V-TCODE	Ancillary time code
EIA-708 Caption	S334-1 EIA 708B Data mapping into VANC space
EIA-608 Caption	S334-1 EIA 608 Data mapping into VANC space
RP207 Program	Program description in VANC space
S334-1 Data	Data broadcast (DTV) in VANC space
RP208 VBI Data	VBI data in VANC space
Mark Deleted	S291 - Packet marked for deletion
S299-2 3G Audio	Audio data in HANC space (3G)
S299-1 HD Audio	Audio data in HANC space (HDTV)
S272 SD Audio	Audio data in HANC space (SDTV)
S315 Camera Pos	Camera position (HANC or VANC space)
RP165 EDH	Error detection and handling (HANC space)
S12-3 HFR TCODE	Time code for high frame rate signals
S2103 Generic Time	Generic time label
S2108-1 HDR/WCG	Extended HDR/WCG

For tooltips on each of the Status Grid Identifiers, hover the mouse cursor over the identifier.



Overview

The **Ancillary (ANC) Inspector** monitors the analyzed signal and displays the contents of selected Ancillary packets in the received data.

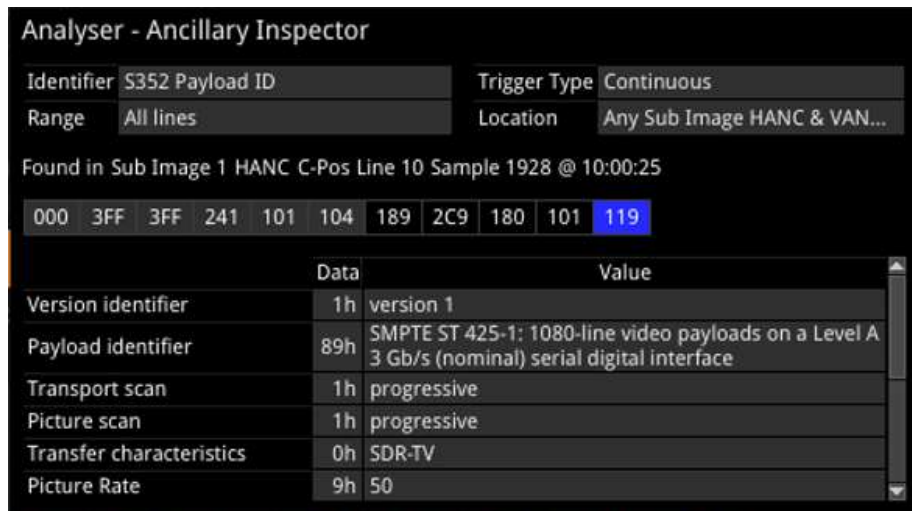

Figure 11-7: Analyzer - Ancillary Inspector Instrument (ST 2022-6 IP and Optional SDI Input)

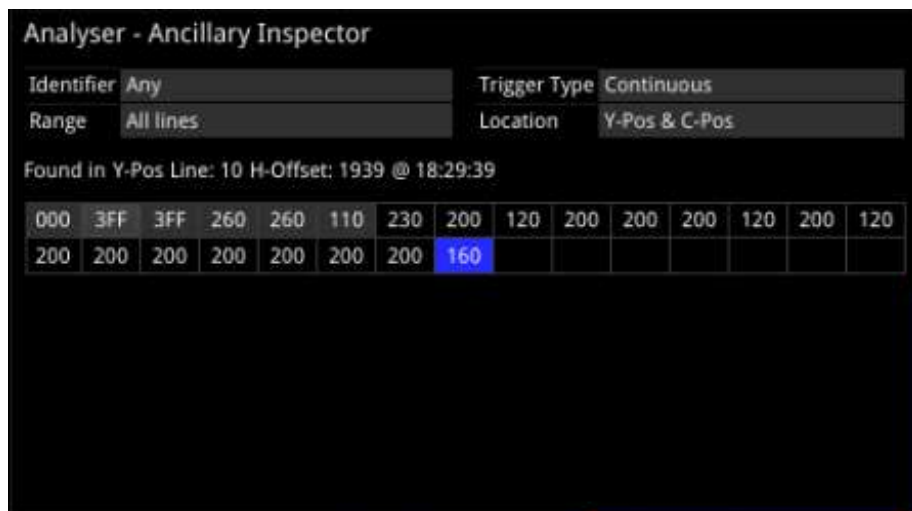

Figure 11-8: Analyzer - Ancillary Inspector Instrument (ST 2110 IP Input)

The window displays both the location of the found packet and the time at which it was found. The lower part of the window displays the packet in hexadecimal form including individual header words (gray background), data words (black background), and checksum (blue background). Hover the mouse over each header word to reveal more detail.

Instrument Menu Options

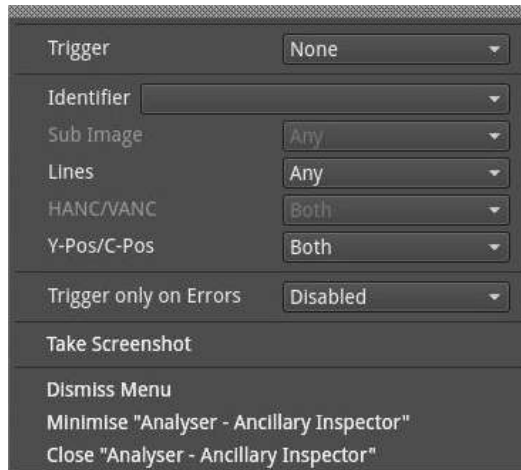

Figure 11-9: Analyzer - Ancillary Inspector Options Menu (ST 2110 IP Input)

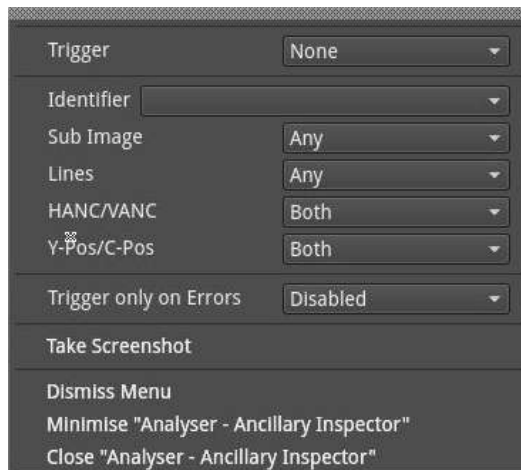

Figure 11-10: Analyzer - Ancillary Inspector Options Menu (ST 2022-6 IP and Optional SDI Input)

The following menu options are available for configuring the **Analyzer - Ancillary Inspector** Instrument:

Table 11-4 : Analyzer - Ancillary Inspector Menu Options

Item	Options	Description
Trigger	None Single Shot Continuous	Set Triggers so that when ancillary data exactly matching the search parameter(s) is detected, the ANC Inspector triggers and displays the inspection result in the lower part of the window. After detecting a matching packet, when the Trigger is set to Single Shot , the inspection result remains in the results display area and the trigger state reverts to None . If the Trigger is set to Continuous , it will remain in the current state after successful detection, and will continuously cause the display to refresh with the results of the next successful detection.
Identifier	None Ancillary Packet Type	Set the Identifier parameter to the ancillary packet type you want to find. For a list of ancillary data identifiers, see the section Analyzer - Ancillary Status .
Sub Image	Any	Additional ANC inspection parameter to use in the data

Item	Options	Description
(ST 2022-6 and Optional SDI Input Only)	Sub Image 1 Sub Image 2 Sub Image 3 Sub Image 4 Sub Ima... Link B Sub Ima... Link B Sub Ima... Link B Sub Ima... Link B	search.
Lines	Any Inside Range Outside Range	Additional ANC inspection parameter to use in the data search.
HANC/VANC (ST 2022-6 and Optional SDI Input Only)	Both HANC VANC	Additional ANC inspection parameter to use in the data search.
Y-Pos/C-Pos	Both Y-Pos C-Pos	Additional ANC inspection parameter to use in the data search.
Trigger only on Errors	Enabled Disabled	When enabled, you can select to enable or disable any of the following: Checksum Errors DBN Errors Parity Errors ANC Gap Errors Note: For ST 2110 IP input, only checksum and parity errors are detected.

You can set the **Identifier** parameter in the submenu of the ANC Inspector to search for the ancillary packet type you want to find.

- **Identifier** > Select from the following available Identifiers:

Table 11-5 : List of Available Ancillary Data Identifiers

Any	Custom	S353 MPEG Recoding VANC Space	S353 MPEG Recoding HANC Space	S305 SDTI
S348 HD-SDTI	S427 Link Encryption Message 1	S427 Link Encryption Message 2	S427 Link Encryption Metadata	S352 Payload ID
S2016-3 AFD	S2016-4 PAN	S2010 ANSI/SCTE	S2031 DVB/SCTE	S2056 MPEG TS
S2068 3D Packing	S2064 Lip Sync	S2108-1 HDR/WCG	ITU-R BT.1685	OP47 Caption
OP47 VBI/WST	ARIB-TR-B29	RDD18 Metadata	RP214 KLV Metadata VANC Space	RP214 KLV Metadata HANC Space
RP223 UMID/ID	S2020No Pair Associated	S2020 Audio Channel Pair 1/2	S2020 Audio Channel Pair 3/4	S2020 Audio Channel Pair 5/6
S2020 Audio Channel Pair 7/8	S2020 Audio Channel Pair 9/10	S2020 Audio Channel Pair 11/12	S2020 Audio Channel Pair 13/14	S2020 Audio Channel Pair 15/16
S2051 Two Frame	RDD8 WSS	S12M-2 V-TCODE	S2103 Generic Time	EIA-708 Caption
EIA-608 Caption	S12-3 HFR TCODE	RP207 Program	S334-1 Data	RP208 VBI Data
Mark Deleted	S299-2 3G Audio Control Group 8	S299-2 3G Audio Control Group 7	S299-2 3G Audio Control Group 6	S299-2 3G Audio Control Group 5
S299-2 3G Audio Audio Group 8	S299-2 3G Audio Audio Group 7	S299-2 3G Audio Audio Group 6	S299-2 3G Audio Audio Group 5	S299-1 HD Audio Control Group 4

S299-1HD Audio Control Group 3	S299-1HD Audio Control Group 2	S299-1HD Audio Control Group 1	S299-1HD Audio Audio Group 4	S299-1HD Audio Audio Group 3
S299-1 HD Audio Audio Group 2	S299-1 HD Audio Audio Group 1	S272 SD Audio Control Group 4	S272 SD Audio Control Group 3	S272 SD Audio Control Group 2
S272 SD Audio Control Group 1	S315 Camera Pos	RP165 EDH	S272 SD Audio Group 4 Ext	S272 SD Audio Audio Group 4
S272 SD Audio Group 3 Ext	S272 SD Audio Audio Group 3	S272 SD Audio Group 2 Ext	S272 SD Audio Audio Group 2	S272 SD Audio Group 1 Ext
S272 SD Audio Audio Group 1				

When setting any parameters in ANC Inspector, AND logic applies; so note that *all* active search parameters must be met before ANC Inspector can successfully display the results of that search. If ancillary packet data in the analyzed SDI data does not meet even one of the search conditions set, it will not be displayed.

In searching for specific data events it is recommended to keep the search parameters as wide as possible first to establish that you are actually seeing data for the selected ANC packet. Only when the ANC Inspector is displaying streaming data, should you introduce more specific search parameters.

ANC Inspector can also be used to search more generally for errors with **Trigger only on Errors** enabled (and Identifier set to Any). Where an error is present in a packet, individual data word text will become red in the display indicating the exact position of an error within a packet.

IP Network Traffic Measurement

Note: Requires the **PHQXLO-IP-MEAS** License.

This chapter describes the advanced IP network traffic measurement instruments available with the IP Measurement option and includes the following sections:

- [IP Receive - Interpacket Timing](#)
- [Analyzer - 2110-21 Status \(ST 2110 IP Input\)](#)
- [Advanced Media Timing Measurement \(ST 2110 IP Input\)](#)

IP Receive - Interpacket Timing



Requires Option(s):

PHQXLO-IP-NGT (For ST 2022-6 IP Input Only) and
PHQXLO-IP-MEAS (Up to Four Timing Windows)

Overview

Each **IP Receive - Interpacket Timing** window displays the interpacket arrival timings, in each second, for a single flow.

The number of simultaneously available interpacket timing windows depends on the type of input to the unit's analyzer as follows:

- **ST 2022-6 IP Input:** Only one interpacket timing window is required for analysis of an ST 2022-6 flow. You can switch between the flows received on SFP E, or SFP F, or both SFP E+F, by selecting from the options menu of the IP Receive - Flows instrument.
- **ST 2110 IP Input:** Up to four interpacket timing windows are available to track the number of simultaneous IP flows that can be selected. You can switch each window between the available flows by selecting from the dropdown list in the Instrument options menu. In addition, you can switch between the flows received on SFP E, or SFP F, or both SFP E+F, by selecting from the options menu of the IP Receive - Flows instrument.

The instrument provides analysis of the IP media flow packet reception, and gives a real-time indication as to the health of the received media flow.

The histogram displays the distribution of all packet arrival intervals, for the selected flow, within a given second, together with the mean, minimum, and maximum packet intervals for this period. Outlier times, significantly longer than the expected mean, may indicate significant delays in packet propagation, or may indicate a gapped linear video sender. A high occurrence of such long intervals is characteristic of high jitter in a network.

Features of the Interpacket Timing window include:

- Stream health reporting using a histogram to visualize the distribution of interpacket arrival times (with dynamic auto-scaling provided)
- Packet counts (log or linear scales) mapped against arrival times (μ s)
- Easy diagnosis of congestion with maximum, mean and minimum interpacket arrival times
- Zoom capability (and linear Y-axis scale) for closer inspection of narrow distribution regions.
- Mouse controls to center, select range, and reset range as follows:
 - Single left-click to center on the mouse position without zooming. This can be used to pan left and right through the histogram.
 - Click and drag to zoom in on the highlighted range. The selected area has a faint green highlight.
 - Single click of the middle mouse button to reset the scale. This reverts the scale to a range where it shows all the data based on the current Min and Max values. You can also reset the scale by selecting the **Reset Scale** control in the instrument options menu, available when Scaling is set to Manual.

Interpacket Timing with ST 2022-6 IP Input

With ST 2022-6 IP input you can select a single video flow for analysis in the interpacket timing instrument. The interpacket timing window displays the arrival time of packets, sampled over one second, where a packet contains video, audio and ancillary data.

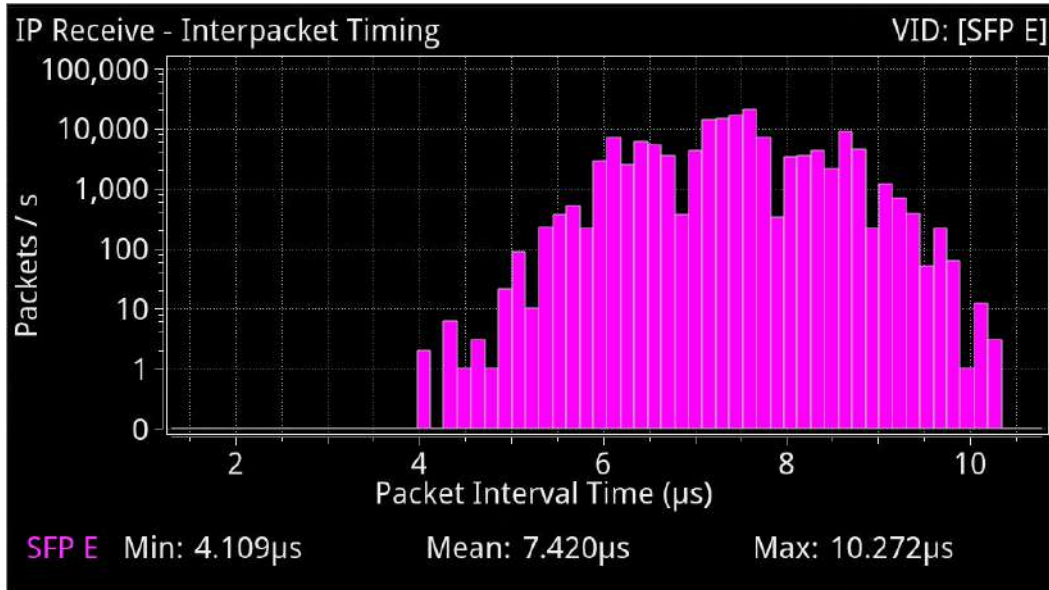

Figure 12-1: IP Receive - Interpacket Timing Instrument (ST 2022-6 IP Input)

When SFP E and F histograms are displayed together, as shown in the following screen, the unit uses SMPTE ST 2022-7 Seamless IP Protection Switching (SIPS) to reconstruct error free ST 2022-6 packets from the flows on both SFP E and SFP F.

- SFP E histograms are colored pink
- SFP F histograms are colored blue
- SFP E + F overlaid histograms are colored purple where they overlap.

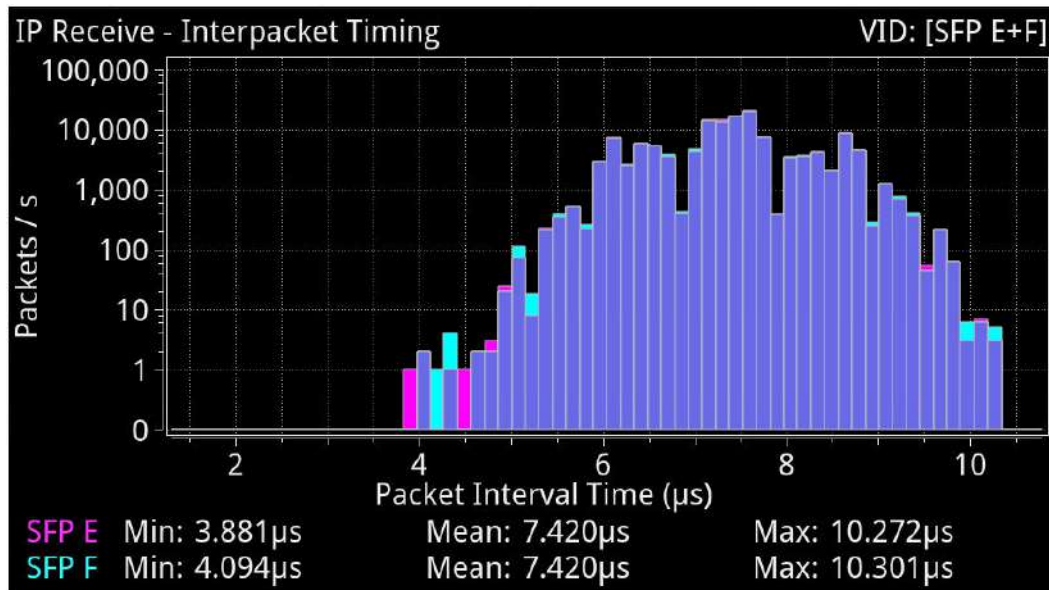

Figure 12-2: IP Receive - Interpacket Timing Using SMPTE ST 2022-7 SIPS on Both SFP E and F

Note: The control for selecting SFP E, SFP F or SFP E + F (Seamless E + F) is available from the dropdown menu of the parameter **2022-7 Mode Selection** in the **IP Receive – Flows** instrument options menu.

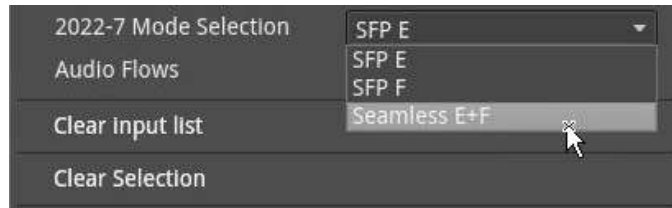

Figure 12-3: SMPTE ST 2022-7 Mode Selection of Seamless E+F in IP Receive - Flows

- Select **Seamless E+F** for **2022-7 Mode Selection** to make a single flow, reconstructed from the flows selected on both SFP interfaces, available for analysis.
- Select **SFP E** to make only SFP E flows available for analysis.
- Select **SFP F** to make only SFP F flows available for analysis.

For more information, see the section [IP Receive - Flows](#) (IP Input).

Instrument Menu Options (ST 2022-6 IP Input)

The menu options available for ST 2022-6 IP input are as follows:

Table 12-1: IP Receive - Interpacket Timing Menu Options (ST 2022-6 IP Input)

Item	Options	Description
Flow	VID: [SFP E] VID: [SFP F] VID: [SFP E+F]	Available options depend on the setting of the parameter 2022-7 Mode Selection in the IP Receive - Flows options menu. This is the only flow required for ST 2022-6 IP input, where the packets contain all video, audio and ancillary data.
Y-Axis Scale	Log10 (Default) Linear	Select whether to plot the number of received packets on the vertical (Y) axis using either a logarithmic or linear scale.
Scaling	Auto (Default) Manual	Select how to control the histogram plot scaling. When using the zoom features, the Scaling setting will default to Manual mode. When Manual scaling is selected, you can reset by clicking the Reset Scale option, which becomes available.

Interpacket Timing with ST 2110 IP Input

With ST 2110 IP input, one video flow, two audio flows, and a single ancillary flow are available for selection.

Note: Monitoring of audio flows **AUD 3** and **AUD 4** is not supported in the current software release.

The Interpacket Arrival Time windows can be set to display the interpacket timing histograms of the flows on either SFP E, SFP F or SFP E + F with the two sets of histograms overlaid on top of each other. The following screen shows the interpacket timing for the flows on SFP E.

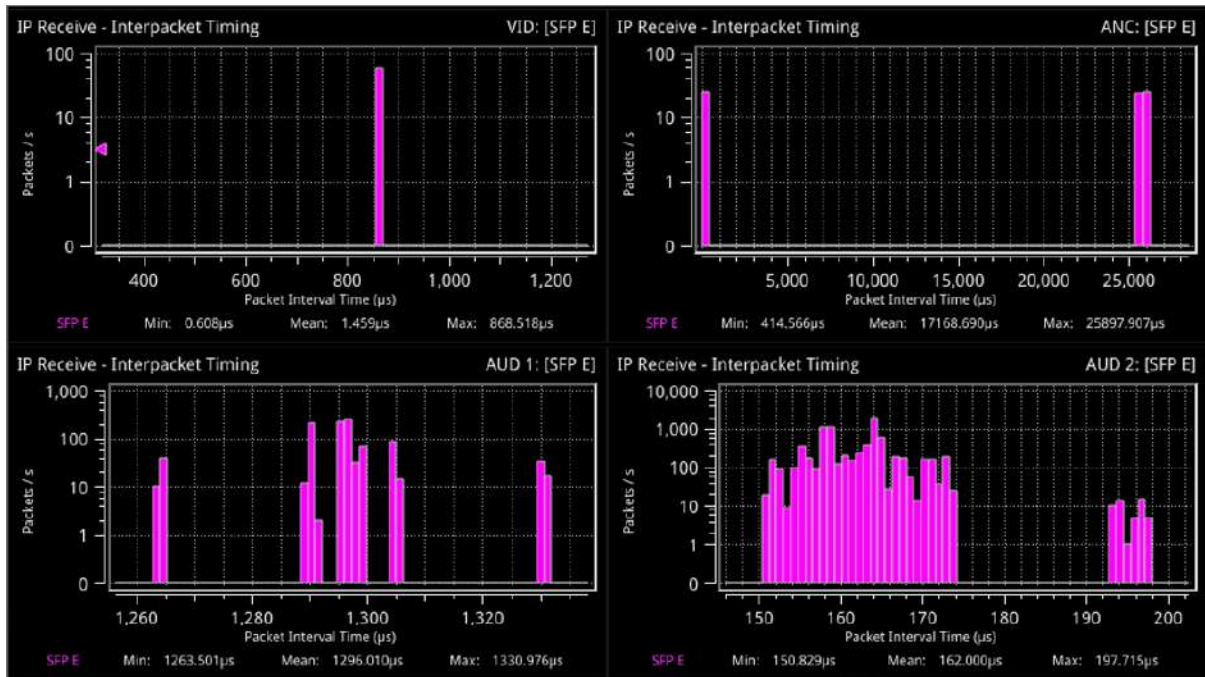

Figure 12-4: IP Receive - Interpacket Timing for ST 2110 IP Input

When SFP E and F histograms are displayed together, as shown in the following screen, the unit uses SMPTE ST 2022-7 Seamless IP Protection Switching (SIPS) to reconstruct error free Video, Audio and ANC from the flows on both SFP E and SFP F.

- SFP E histograms are colored pink
- SFP F histograms are colored blue
- SFP E + F overlaid histograms are colored purple where they overlap.

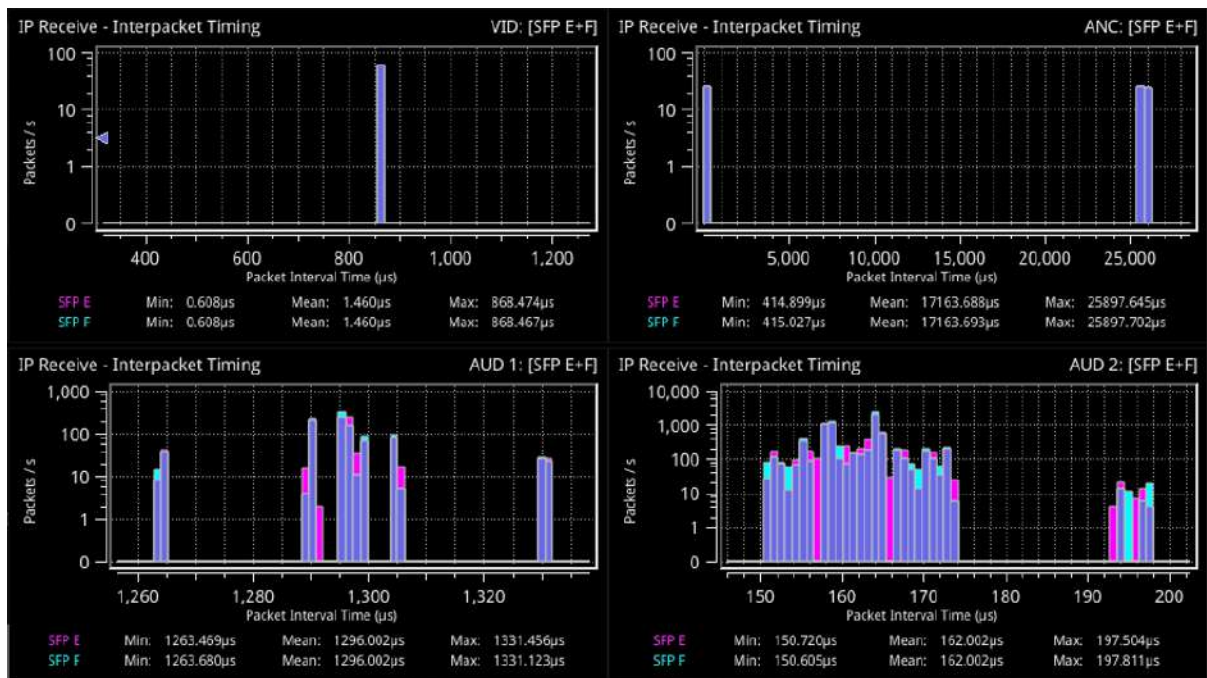

Figure 12-5: IP Receive - Interpacket Timing Using SMPTE ST 2022-7 SIPS on Both SFP E and F

Note: The control for selecting SFP E, SFP F or SFP E + F (Seamless E + F) is available from the dropdown menu of the parameter **2022-7 Mode Selection** in the **IP Receive – Flows** instrument options menu.



Figure 12-6: SMPTE ST 2022-7 Mode Selection of Seamless E+F in IP Receive - Flows

- Select **Seamless E+F** for **2022-7 Mode Selection** to make a single flow, reconstructed from the flows selected on both SFP interfaces, available for analysis
- Select **SFP E** to make only SFP E flows available for analysis
- Select **SFP F** to make only SFP F flows available for analysis.

For more information, see the section [IP Receive - Flows](#) (IP Input).

Instrument Menu Options (ST 2110 IP Input)

The following shows the options available in the instrument options menu:

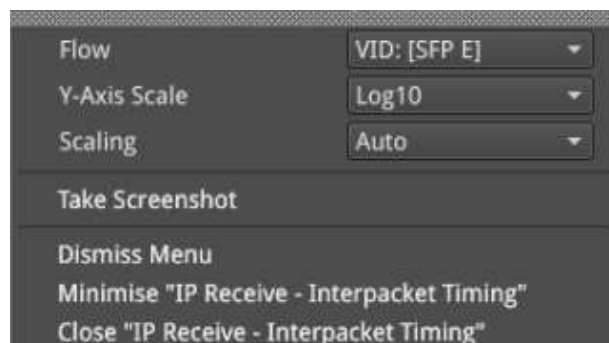

Figure 12-7: IP Receive - Interpacket Timing Menu Options

The menu options available for ST 2110 IP input are as follows:

Table 12-2 : IP Receive - Interpacket Timing Menu Options (ST 2110 IP Input)

Item	Options	Description
Flow	VID: [SFP E], AUD 1: [SFP E], AUD 2: [SFP E], ANC: [SFP E] VID: [SFP F], AUD 1: [SFP F], AUD 2: [SFP F], ANC: [SFP F] VID: [SFP E+F], AUD 1: [SFP E+F], AUD 2: [SFP E+F], ANC: [SFP E+F]	Select a flow to display in the active window. Note: Available flows are dependent on the option selected in 2022-7 Mode Selection of the IP Receive – Flows Instrument.
Y-Axis Scale	Log10 (Default) Linear	Select whether to plot the number of received packets on the vertical (Y) axis using either a logarithmic or linear scale.
Scaling	Auto (Default) Manual	Select how to control the histogram plot scaling. When using the zoom features, the Scaling setting will default to Manual mode. When Manual scaling is selected, you can reset by clicking the Reset Scale option, which becomes available.

Analyzer - 2110-21 Status (ST 2110 IP Input)



Requires Option(s):	PHQXLO-IP-MEAS
---------------------	----------------

Overview

The **2110-21 Status** instrument performs real-time measurements of the parameters constituting the Transmission Traffic Shaping *Leaky Bucket* Models as defined in SMPTE ST 2110-21. The standard describes the following two models:

- Network Compatibility Model (C_{Max})
- Virtual Receiver Buffer Model (VRX_{Full})

Use these measurements to determine whether a sender or transmitter meets the requirements to be defined as one of the following types:

- Narrow: Type **N** (gapped)
- Narrow Linear: Type **NL**
- Wide: Type **W**



Figure 12-8: Analyzer - 2110-21 Status Instrument

Note: If the 2110-21 Status instrument is active but the unit is configured to analyze either an ST 2022-6 IP or optional SDI input, you will see the following warning message displayed in the window: **Invalid Input.**

To resolve, make sure that the analyzer input is set to **IP** and that the input source is **ST 2110**.

The graph in the **2110-21 Status** instrument displays the number of packets in the *leaky bucket* buffer. A hardware-based sender will typically be able to establish a carefully controlled read schedule of packets with low levels of packet jitter and highly accurate RTP timestamps and would typically, therefore, be classified as a **Narrow Sender**. A software-based sender, without any hardware assistance, would typically struggle to achieve the same level of control as a hardware-based device and may, consequently, be classified as a **Wide Sender**.

This is an important parameter for a receiving device, as a device with a small buffer (with low latency) may only be capable of handling flows from a Narrow Sender, and is defined as a **Narrow Receiver**. A receiver that can accept flows from both Narrow and Wide Senders will have a larger buffer (with larger latency) and is defined as a **Wide Receiver**. The unit is a Wide Receiver.

The compatibility of the unit is as follows:

Table 12-3 : ST 2110-21 IP Status Compatibility

Sender	Receiver	Unit Compatible ?
Narrow (Gapped or Linear)	Narrow	Yes
	Wide	Yes
Wide	Narrow	No
	Wide	Yes

Note: The ST 2110-21 specification is a direct measure of the Sender without any intervening network, which will typically introduce packet jitter. Practical measurements made with a switch or router in circuit may not be a true measure of the source. You can use this measurement, however, to establish whether a source, in conjunction with a real network, requires a Narrow or Wide Receiver; a consideration which may be useful in low-latency applications.

The thresholds for the maximum values of C_{Full} and VRX_{Full} for Narrow and Wide Senders varies with video format and bit depth. A sender must satisfy both criteria, for example:

Table 12-4 : Narrow and Wide Sender Thresholds for Max C_{Full} and VRX_{Full} by Video Format

V	H	T	Color	Bit	C_{MaxN}	C_{MaxW}	VRX_{FullN}	VRX_{FullW}
1280	720	50	4:2:2	10	4	16	8	720
1280	720	60	4:2:2	10	4	16	8	720
1920	1080	25	4:2:2	10	4	16	8	720
1920	1080	50	4:2:2	10	4	16	8	720
1920	1080	60	4:2:2	10	5	16	8	726
1920	1080	50	4:2:2	12	5	16	8	726
1920	1080	60	4:2:2	12	5	16	8	726

Note: Minimum reported values represent the value of the *gap* in a gapped flow as the 2110-21 Status measurements are not windowed.

Measurements and Instrument Menu Options

Measurement Prechecks

Before starting any measurements ensure that the video format parameters entered in the **Analyzer - 2110 Format Setup** Instrument match the video format of the sender.

Network Compatibility Model Measurement (C_{Inst})

The **Analyzer - 2110-21 Status** submenu for the C_{Inst} parameter contains the following options:

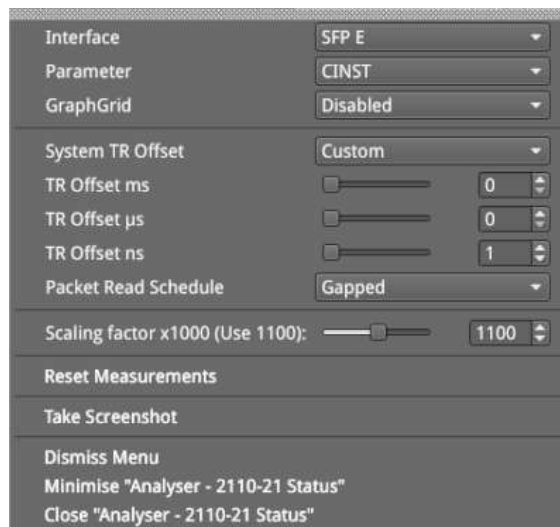

Figure 12-9: Analyzer - 2110-21 Status Menu Options for the C_{INST} Parameter

The **C_{INST}** measurement represents the instantaneous number of packets in the *leaky-bucket* buffer model, averaged over one (1) second.

This measurement is performed with a drain rate (beta) of 1.1, that is, the measurement buffer is being drained 1.1 times faster than it is being filled. The residue of packets in the buffer model is, therefore, an indication of the peak rate at which packets were being delivered into the buffer by the sender.

The configurable parameters available for the **C_{INST}** measurement are as follows:

Table 12-5 : Analyzer - 2110-21 Status - C_{INST} Measurement Options

Item	Options	Description
Interface	SFP E SFP F	Select the target interface for the Analyzer - 2110-21 instrument. When analyzing 2022-7 flows, you switch between SFP E and SFP F.
Parameter	C _{INST} VRX	Select the target measurement for the Analyzer - 2110-21 Status Instrument.
GraphGrid	Enabled (Default) Disabled	When enabled, displays a graphical grid pattern in the instrument background.
System TR Offset	TRO Default (Default) Custom	Defines the timing reference offset (TR Offset) setting. The TR Offset is either a default value based on the current video standard (TRO Default) or a value defined by the sender to account for network delay. Select whether to use the default (TRO Default) as the time at which the read schedule begins on each frame, or select Custom to override the default with a manual TR Offset by adjusting the TR Offset sliders described below to set the granularity in ms, μs and ns. The read schedule must be set to match that of a Gapped or Linear source, see the Gapped Mode option below.
TR Offset Slider Controls	ms, μs, ns	Adjust the slider controls to compensate for the source Video Timing (TR Offset) to obtain an accurate and consistent measurement of C_{INST} .
TR Offset ms	0 to 9	Set the timing reference offset in milliseconds (ms).
TR Offset μs	0 to 999	Set the timing reference offset in microseconds (μs).
TR Offset ns	0 to 999	Set the timing reference offset in nanoseconds (ns).

Item	Options	Description
Gapped Mode	Enabled Disabled	For a Gapped source, ensure that you enable the option Gapped Mode .
Packet Read Schedule	Gapped (Default) Linear	Select the appropriate packet read schedule for use with the SMPTE ST 2110-21 standard; either Gapped or Linear.
Scaling factor x1000 (Use 1100)	100 to 2000	Use the Scaling factor control to change the drain rate presented as 1000 x the drain rate. The default setting is 1100 (x 1.1). If you reduce the scaling factor to 1000, then the drain rate becomes equal to the write rate (x 1.0) and the value of C_{INST} represents the size of the buffer.
Reset Measurements	System control	Use this control to reset the measurement to the start.

Note: It is possible to make this measurement if the underlying media is not locked to PTP, however, the encapsulator of the sender should be locked to PTP for this measurement to be valid.

Virtual Receiver Buffer Measurement (VRX)

A Video RTP sender is required to ensure that the variation in the interval between packets (the instantaneous (or INST) rate) meets the parameters for either a narrow or wide sender. These packets are written into the *leaky-bucket* buffer and are then drained at a precise read schedule. The sender is required to ensure that the maximum size of the leaky-bucket buffer does not exceed the value of **VRX_{Full}** for that format and does not underflow, that is, the minimum value of VRX should not be negative.

The **Analyzer - 2110-21 Status** submenu for the **VRX** parameter contains the following options:

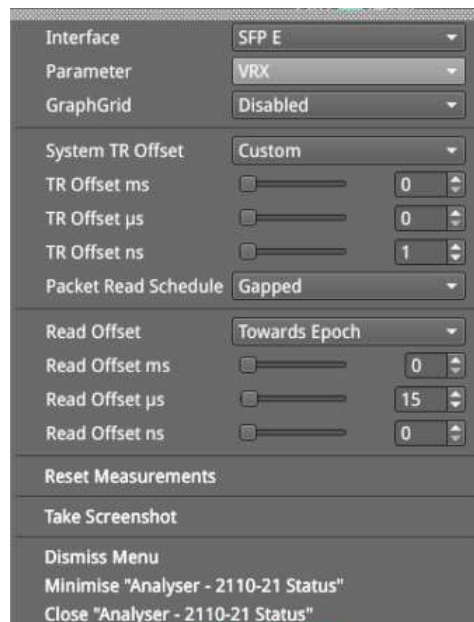

Figure 12-10: Analyzer - 2110-21 Status Menu Options for the VRX Parameter

The configurable parameters available for the **VRX** measurement are as follows:

Table 12-6 : Analyzer - 2110-21 Status - VRX Measurement Options

Item	Options	Description
Interface	SFP E SFP F	Select the target interface for the Analyzer - 2110-21 instrument. When analyzing 2022-7 flows, you switch between SFP E and SFP F.
Parameter	CINST VRX	Select the target measurement for the Analyzer - 2110-21 Status Instrument.
GraphGrid	Enabled (Default) Disabled	When enabled, displays a graphical grid pattern in the instrument background.
System TR Offset	TRO Default (Default) Custom	Defines the timing reference offset (TR Offset) setting. The TR Offset is either a default value based on the current video standard (TRO Default) or a value defined by the sender to account for network delay. Select whether to use the default (TRO Default) as the time at which the read schedule begins on each frame, or select Custom to override the default with a manual TR Offset by adjusting the TR Offset sliders described below to set the granularity in ms, μ s and ns. The read schedule must be set to match that of a Gapped or Linear source, see the Gapped Mode option below.
TR Offset Slider Controls	ms, μ s, ns	Adjust the slider controls to compensate for the network delay, any PTP phase offset, and if required the source Video Timing (TR Offset), to obtain an accurate and consistent measurement.
TR Offset ms	0 to 9	Set the timing reference offset in milliseconds (ms).
TR Offset μ s	0 to 999	Set the timing reference offset in microseconds (μ s).
TR Offset ns	0 to 999	Set the timing reference offset in nanoseconds (ns).
Gapped Mode	Enabled Disabled	For a Gapped source, ensure that you enable the option Gapped Mode .
Packet Read Schedule	Gapped (Default) Linear	Select the appropriate packet read schedule for use with the SMPTE ST 2110-21 standard; either Gapped or Linear.
Read Offset	From Epoch (Default) Toward Epoch	The Read Offset is the time at which packets are read from the <i>leaky bucket</i> . Enables you to set the custom offset relative to the Epoch time, where the Epoch is 00:00:00 UTC on 01 January 1970.
Read Offset Slider Controls	ms, μ s, ns	Adjust the slider controls to compensate for the network delay, any PTP phase offset, and if required the source Video Timing (TR Offset), to obtain an accurate and consistent measurement of VRX.
Read Offset ms	0 to 100	Set the timing reference offset in milliseconds (ms).
Read Offset μ s	0 to 999	Set the timing reference offset in microseconds (μ s).
Read Offset ns	0 to 999	Set the timing reference offset in nanoseconds (ns).
Reset Measurements	System control	Use this control to reset the measurement to the start.

You can use the **Read Offset** control for either of the following tasks:

- To perform a SMPTE ST 2110-21 measurement
- To measure the required Read Offset to ensure that the leaky-bucket does not underflow.

To perform the 2110-21 measurement: set the value of the Read Offset to match the value of the network delay. The 2110-21 Instrument will now report the peak sizes (both positive and negative) of the leaky-bucket buffer. A negative minimum value indicates that the buffer has underflowed.

To measure the Read Offset: adjust the Read Offset controls so that the **VRX_{Min}** value is zero and simultaneously that the **VRX_{Max}** value is also minimized. The value of the Read Offset with the minimum value for **VRX_{Max}** and with **VRX_{Min}** of zero is an indication of the required read offset to ensure that there is no underflow. This measurement will be affected by the network latency, PTP Phase of the sender and the unit, and the Video Timing (**TR_{Offset}**).

The measurement is sensitive to the time difference between the Write and Read schedules and will vary with the source Video Timing (**TR_{Offset}**). If the Source Video Timing is not equal to **TRO_{Default}**, then, if required, you can compensate for this by choosing **Custom** mode and entering the value from the **Video Timing & System Reference** Instrument.

Note: For this measurement to be valid, both the underlying media and the source encapsulator must be locked to PTP.

Advanced Media Timing Measurement (ST 2110 IP Input)

Requires Option(s):	PHQXLO-IP-MEAS
---------------------	----------------

Overview

The Advanced Media Timing measurement functions are provided with the license **PHQXLO-IP-MEAS**.

These advanced functions give you access to additional measurements from the standard Video Timing & System Reference instrument, which provide critical information on the performance of your media network.

The advanced **Video Timing & System Reference** instrument is extended in width, by default, to display the actual flow data to complement the visual information in the flow timing meters.

Note: The unit must be locked to PTP for the advanced media timing measurements to be valid.

Note: The unit has a PTP phase control that you can use to align the one pulse per second (1 PPS) of the unit with that of the PTP Grandmaster. The use of this control reduces any PTP-related timing measurement uncertainty caused by PTP network asymmetry, however, there may still be a PTP phase uncertainty introduced by the sending device. For more information, see the section [SFP E/F - PTP Info \(ST 2110 IP Input\)](#).

When your system includes the **PHQXLO-IP-MEAS** license, the **Video Timing & System Reference** window includes the following three tabs, providing access to different timing data:

- Video Timing
- Media Latency
- External Reference vs PTP

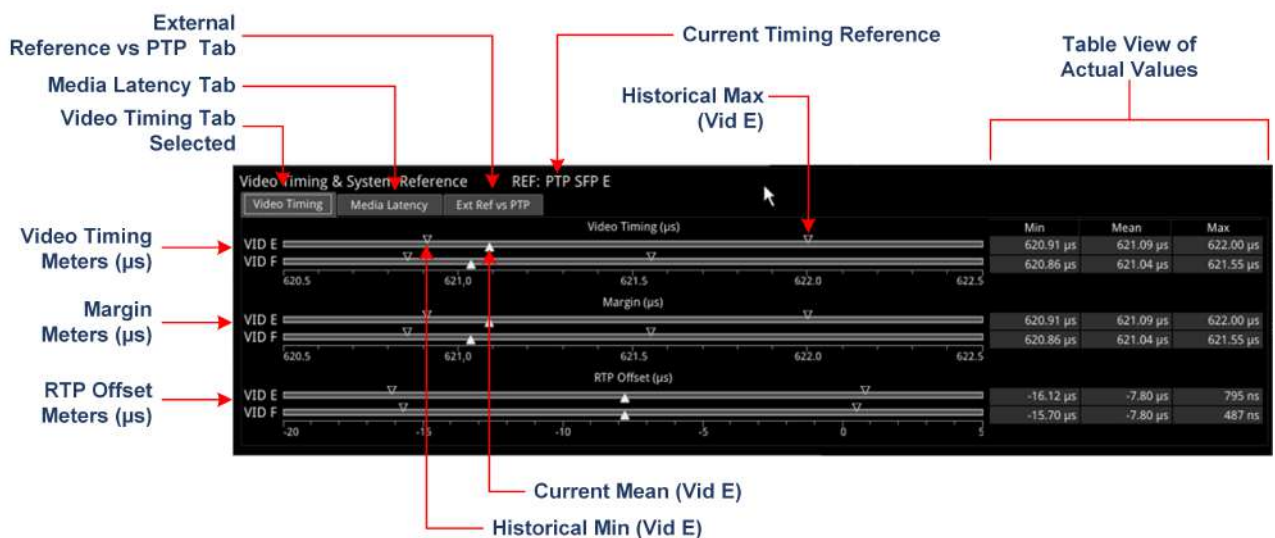

Figure 12-11: Components of the Video Timing & System Reference Instrument (ST 2110 IP Input)

Using the Advanced Video Timing Tab

The Advanced Video Timing tab provides listings of the actual historical minimum, mean and maximum values in the Min, Mean and Max columns to the right of the timing meters.

The advanced Video Timing tab displays the following measurements:

- Video Timing (μs)
- Margin (μs)
- RTP Offset (μs)

Detailed information about the Video Timing tab and these measurements is provided in the Appendix, see: [Advanced Media Timing Measurements](#).

Using the Advanced Media Latency Tab

The advanced **Media Latency** tab provides additional media latency measurements to those in the standard instrument.



Figure 12-12: Media Latency Tab of the Video Timing & System Reference Instrument (ST 2110 IP Input)

The displays the media latency data in the following columns for each flow:

- **Min:** Minimum historical flow latency (since last reset)
- **Mean:** Mean current flow latency (since last reset)
- **Max:** Maximum historical flow latency (since last reset)
- **From Vid:** Displays the difference in latency for the audio (**E AUD 1** and **E AUD 2**) and ancillary (**E ANC**) flows from their related video (**E VID**) flow. If the flow arrives earlier than its related video flow, the value is negative and if it arrives later, the value is positive.
- **RTP clks:** Actual value of the RTP Clock, averaged over one second. For more information, see the section [RTP Clock and Timestamps](#).
- **TSs:** Number of timestamps received over one second. For more information, see the section [RTP Clock and Timestamps](#)
- **RTP clks/TS:** Quotient of RTP clks and TS provides a measure of the number of RTP Clocks per timestamp. For more information, see the section [RTP Clocks per Timestamp Quotient \(RTP/TS\)](#).

Note: Monitoring of audio flows **AUD 3** and **AUD 4** is not supported in the current software release.

To see more detail about the media latency, you can zoom in on a specific area of interest by clicking anywhere on a timing meter of interest, which changes the scale to match the values of the specific flow. For example, when zooming into a video flow, the scale changes from milliseconds (ms) to

microseconds (μs). Click the meter again to zoom out and return to the overview. You can also switch between overview and zoom for individual flow meters by selecting the specific meter from the instrument submenu, as described in the Instrument options table.

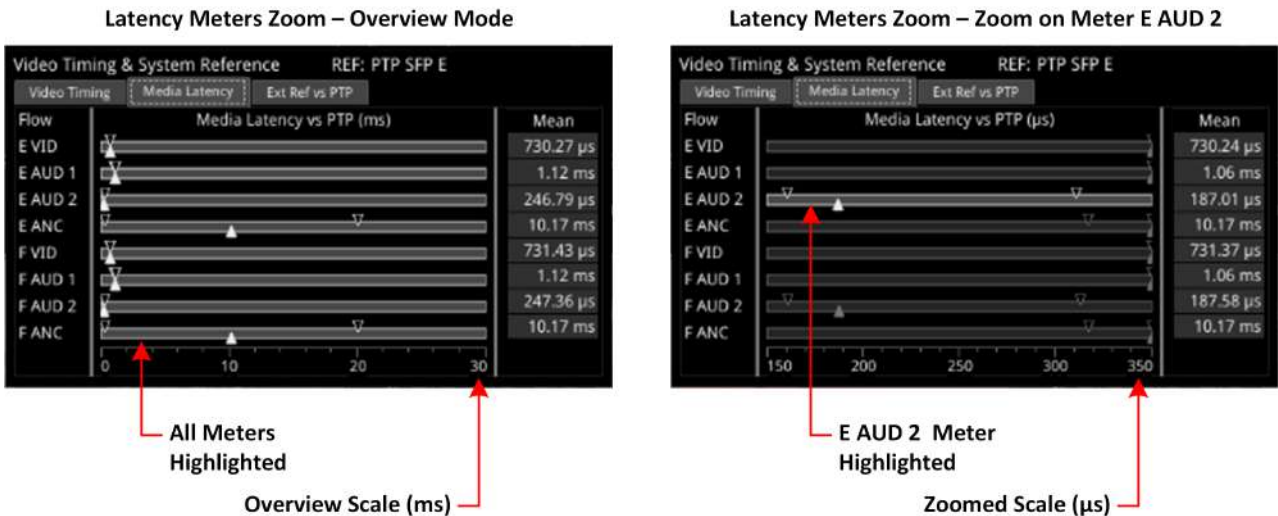

Figure 12-13: Media Latency Tab of the Video Timing & System Reference Instrument (ST 2110 IP Input)
 Detailed information about the Media Latency measurement is provided in the Appendix [Advanced Media Timing Measurements](#).

Instrument Menu Options

The following table lists the options available in both the standard and advanced **Video Timing & System Reference** Instrument submenu:

Table 12-7 : Video Timing & System Reference - Menu Options

Item	Options	Description
System Reference	Free Run (Default) PTP SFP E PTP SFP F	System reference locking controls define the reference to which the unit and any signal it generates is locked. For ST 2110 IP input, make sure that the system reference on either SFP E or F is stably locked to the same PTP source as the sending device. System reference lock status information is displayed in the upper-right corner of the instrument, and any error in the health state of the reference is displayed in red.
Ext Ref Termination	Enabled (Default) Disabled	When enabled, adds an internal 75 ohm termination to the reference input to stabilize the system reference signal.
Reference Timing Meter Range	+/- 0.1 line, +/- 0.5 line, +/- 0.5 frame	Adjusts the displayed range of the reference timing meter in the upper section of the Instrument to display readings at frame scale, or to zoom in to a fraction of a line.
System TR Offset	TRO Default Custom	Defines the timing reference offset (TR Offset) setting. The TR Offset is either a default value based on the current video standard (TRO Default) or a value defined by the sender to account for network delay. When you select TR Offset, you can set the TR Offset by adjusting the TR Offset sliders described below to set the granularity in ms, μ s and ns.
TR Offset ms	0 to 9	Set the timing reference offset in milliseconds (ms).
TR Offset μ s	0 to 999	Set the timing reference offset in microseconds (μ s).
TR Offset ns	0 to 999	Set the timing reference offset in nanoseconds (ns).
Wrap Video Timing	Enabled / Disabled (Default)	When enabled, displays video timing values exceeding half a TV frame period as a negative time value relative to the next TV frame, rather than as a positive value. For example, for a frame of 20 ms, if the frame end is measured at 30 ms, the unit will display this as - 10 ms instead of 30 ms.
Wrap Margin	Enabled / Disabled (Default)	When enabled, displays margin timing values exceeding half a TV frame period as a negative time value relative to the next TV frame, rather than as a positive value.
Wrap RTP Offset	Enabled / Disabled (Default)	When enabled displays RTP Offset timing values exceeding half a TV frame period as a negative time value relative to the next TV frame, rather than as a positive value.
Latency Meters Zoom	Overview, E VID, E AUD 1, E AUD 2, E ANC, F VID, F AUD 1, F AUD 2, F ANC	Select a specific timing meter to switch between overview and zoomed-in view.

Item	Options	Description
Anchor time scale start in Overview mode	Zero (0) or less, Any value	Set the start point of the timescale when in Overview.
Clear Min, Max values	N/A	Set the historical minimum and maximum values back to zero.

12G Physical Layer Analysis

Note: Requires the **PHQXL01E-3G Mezzanine** Factory-fitted hardware option.

This chapter describes the Instruments available with the 12G-SDI Physical Layer Analysis Toolset option and includes the following sections:

- [Eye - SDI In A](#)
- [Jitter - SDI In A](#)

Eye - SDI In A (Physical Layer Analysis)



Requires Option(s):	PHQXL01E-3G
---------------------	-------------

Overview

The optional instrument **Eye - SDI in A**, available in the **Physical Layer Analysis** toolset, enables you to analyze physical layer compliance measurements from 270 Mbps to 12 Gbps for optional SDI input. An analog front-end provides a bandwidth of more than 30 GHz (5th harmonic of the 6 GHz fundamental for 12G-SDI.) The GUI uses PHABRIX RealTime Eye (RTE™) to generate a reliable, AC coupled, instantaneous physical layer display with automatic measurements to SMPTE standards. You can receive accurate measurements within seconds of connecting an SDI input (optional). The unit enables you to measure both rise and fall overshoot at the top and bottom of the waveform. In addition, the unit displays amplitude, rise and fall overshoot delta and DC offset - all compulsory measurements when testing against SMPTE standards. The unit highlights any measurements exceeding the specification (for example, an eye amplitude greater than 10 %) in red.

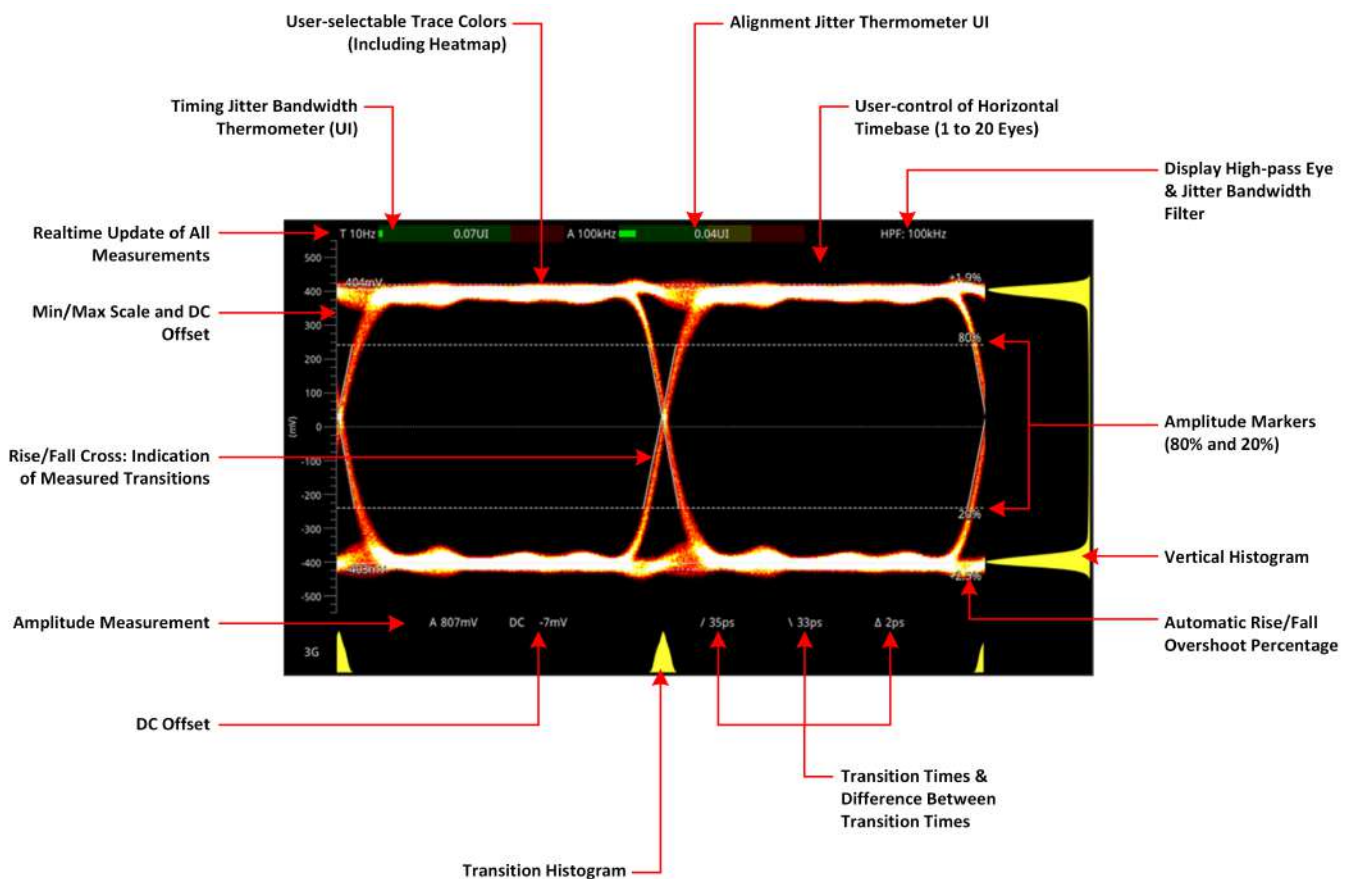

Figure 13-1: Standard SDI Eye Pattern Display (3G) with 100 kHz Jitter Filter (Optional SDI Input)

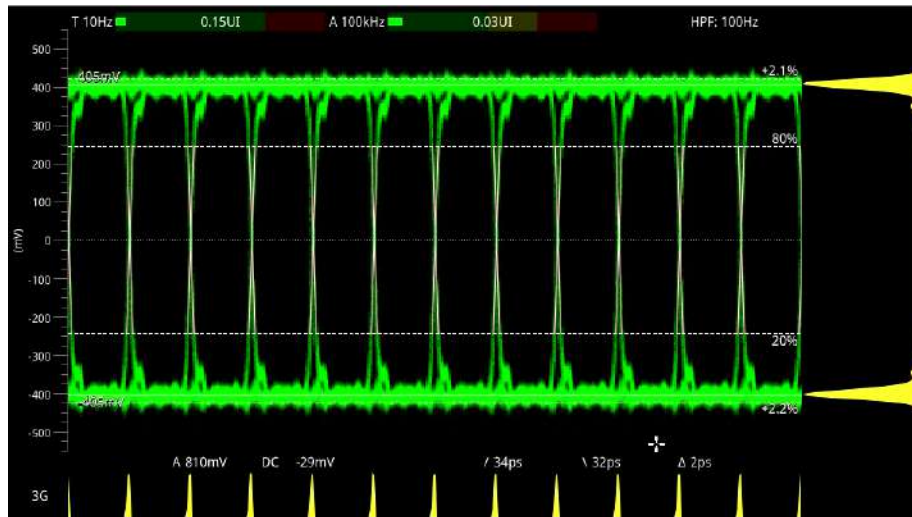

Figure 13-2: 3G-SDI Eye Pattern Set to Display 12 Eyes (Using Green Display Color) (Optional SDI Input)

Note: A black (or red) nut fitted to the **SDI In A** BNC identifies the connector with access to the eye and jitter circuitry.

Note: The use of SDI SFP inputs with **Eye - SDI In A** is not supported.

The **Eye - SDI In A** instrument display also provides:

- Timing jitter thermometer color-coded according to the analyzed SDI standard
- Alignment jitter thermometer color-coded according to the analyzed SDI standard
- Positive and negative Eye amplitude values
- On screen indication of 20 % and 80 % levels for rise and fall time measurement
- Horizontal time histogram of eye crossing point (0 mV threshold)
- Vertical amplitude histogram indicating energy distribution across all samples
- Eye coupled to AC with display of DC offset measurement.

Instrument Menu Options

The following table lists the configurable parameters in the options menu of the Physical Layer Analysis toolset.

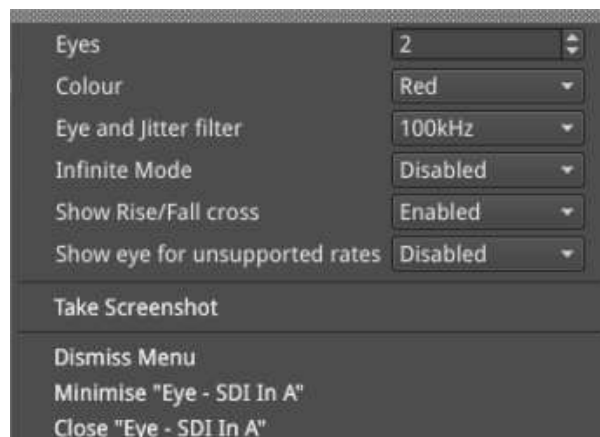

Figure 13-3: Eye - SDI In A Menu Options

Table 13-1 : Menu Options for the Eye - SDI In A Instrument (Optional SDI Input)

Item	Options	Description
Standard Physical Layer Analysis Tools		
Eyes	1 to 20 (Default = 2)	Sets the default number of eyes displayed in the Instrument window.
Color	Green Heat Red Ferrara Green-red Blacklight	Sets the color scheme for the eye display.
Eye and Jitter Filter	10 Hz 100 Hz 1 kHz 10 kHz 100 kHz	Sets the frequency of the default jitter filter. Note: This setting controls the filter applied both to the Eye - SDI In A instrument and the Jitter - SDI A instrument.
Infinite Mode	Disabled (Default) Enabled	When disabled, eye data points are displayed for a fixed persistence interval and then removed from the display. When enabled, infinite mode ensures that no data points are removed from the eye display over time, so you will probably observe the eye shape thickening and becoming less distinct. This can be useful when attempting to identify anomalies in the signal which appear sporadically over time and might be missed in the standard mode.
Show Rise/Fall Cross	Disabled (Default) Enabled	Toggle the display of the rise/fall crossing point, which gives a visual indication of the rise and fall time measurements.
Show eye for unsupported rates	Disabled (Default) Enabled	Toggle the display of eyes for rates currently unsupported by the unit. Note: This setting is transient, enabling support of officially unsupported rates. The setting reverts to default following a reboot.

A table showing the SMPTE tolerances for each standard is provided in the section [SMPTE UHD TV: SDI Physical Layer Tolerances](#).

Jitter - SDI In A (Physical Layer Analysis)



Requires Option(s):

PHQXL01E-3G

Overview

The **Jitter** toolset is available on the **SDI In A** BNC - the rear panel connector, fitted with the black (or red) nut, for optional SDI input.

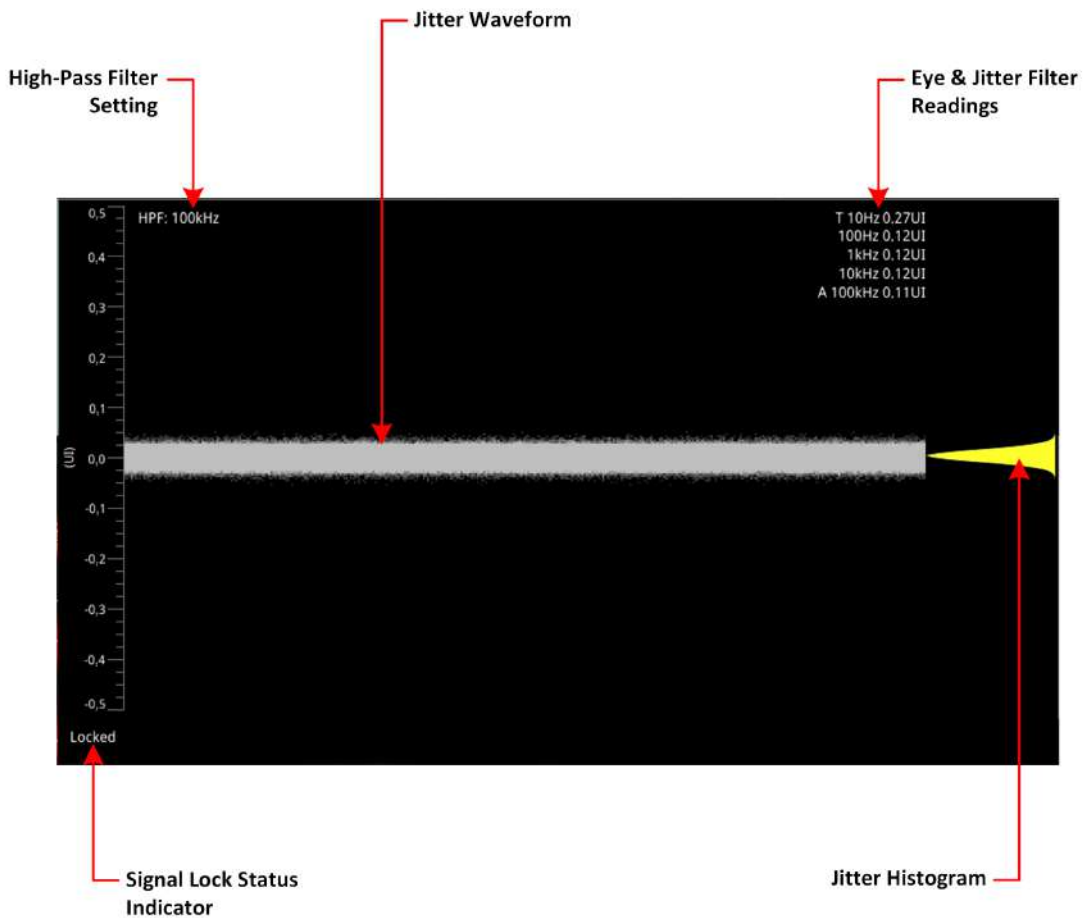

Figure 13-4: Jitter SDI In A Instrument (Optional SDI Input)

The **Jitter SDI in A** instrument displays automated measurements to SMPTE standards. A Jitter histogram, displayed at the right of the window in yellow, provides additional information about the jitter waveform.

Readings for each of the filters are displayed as an overlay in the top-right corner of the instrument window. Any values displayed in red text indicate a reading outside the current specification.

A signal lock status indicator (**Locked / Unlocked**) in the bottom-left corner of the window indicates the quality of the Eye pattern as follows:

- **Unlocked (grayed-out):** No signal available
- **Unlocked (red font):** Eye pattern is *unlocked* or jittery
- **Locked (white font):** Eye pattern is locked, stable and not jittery.

The Jitter and Eye analysis instruments, used in conjunction with the **Jitter Insertion Mode** feature of the **Generator** and the Stress Toolkit [option: **PHQXO-SDI-STRESS**], provide an end-to-end toolset for jitter generation and analysis.

Note: The use of SDI SFP inputs with the **Jitter - SDI In A** toolset is not supported.

Instrument Menu Options

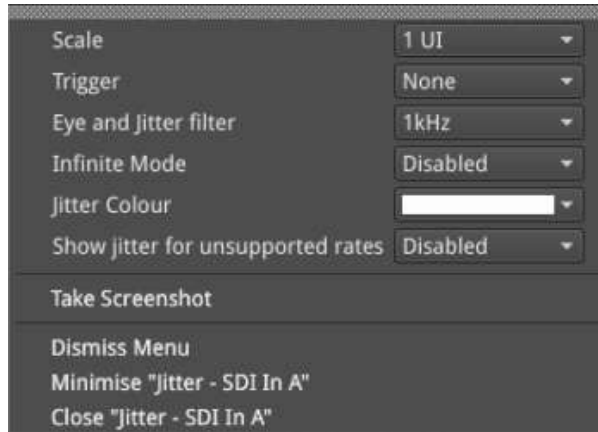

Figure 13-5: Jitter - SDI In A Instrument Menu Options

The following table lists the configurable parameters in the Jitter instrument options menu:

Table 13-2 : Jitter - SDI In A Menu Options

Item	Options	Description
Scale	1 UI (Default) to 128 UI	Adjust the scale of the Y-axis in graticule adjustments from 1 UI to 128 UI
Trigger	None (Default) Single Line Two Lines Single Field Frame	Select a trigger for jitter measurement. Trigger modes are useful to correlate jitter content to line and frame-rate frequencies.
Eye and Jitter Filter	10 Hz 100 Hz 1 kHz 10 kHz 100 kHz (Default)	This setting controls the high-pass filter applied to both the Jitter - SDI In A instrument and the Eye - SDI In A instrument. If you hover over the HPF field in the top-left of the screen, a tooltip displays the frequency response of the current high-pass filter.
Infinite Mode	Enabled Disabled (Default)	When disabled, jitter data points are displayed for a fixed persistence interval and then removed from the display. When enabled, infinite mode ensures that no data points are removed from the display over time.
Jitter Color	White (Default) Select from the color map.	Color selection is by way of an HSV tool providing two cursors. The left-hand color rectangle allows you to select the hue (horizontal) and saturation (vertical). The right-hand vertical bar selects color lightness.
Show Jitter for Unsupported Rates	Enabled Disabled (Default)	Toggle the display of jitter for rates currently unsupported by the unit. Note: This setting is transient, enabling support of officially unsupported rates. The setting reverts to default following a reboot.

Stress-testing Analysis Instruments

Note: Requires the **PHQXL01E-3G Mezzanine** Factory-fitted hardware option and the **PHQXLO-SDI-STRESS** License.

The Stress-testing analysis Instruments provide additional SDI stress-testing functions and complement the Physical Layer Analysis Instruments described in the previous chapter.

This chapter describes the advanced stress testing Instruments available with the SDI-Stress Toolset option and includes the following sections:

- [Advanced Generation Tools](#)
- [Eye - SDI In A](#)
- [PRBS Analysis](#)

Advanced Generation Tools (Optional SDI Input - Stress Option)



Requires Option(s):	PHQXLO-GEN, PHQXL01E-3G and PHQXLO-SDI-STRESS
---------------------	---

Overview

As part of the Advanced SDI Stress Toolset [**PHQXLO-SDI-STRESS**], advanced generation tools are provided in the **Generator** instrument options menu, for SDI input (Factory Fitted Option). The toolset provides the following:

- Control over SDI scrambler switch-off
- Sync bit insertion
- Sync bit removal function in the [Dataview](#) instrument for 6G-SDI and 12G -SDI video standards
- A PRBS (pseudo-random binary sequence) mode for end-to-end bit error rate testing (BERT)
- SDI BER Mode
- Advanced jitter generation controls – facilitating the generation and bespoke adjustment of jitter measurement parameters
- Slew rate adjustment
- SDI output gain control
- Driver pre-emphasis
- Cable compensation.

These tools support a wide range of advanced testing and troubleshooting.

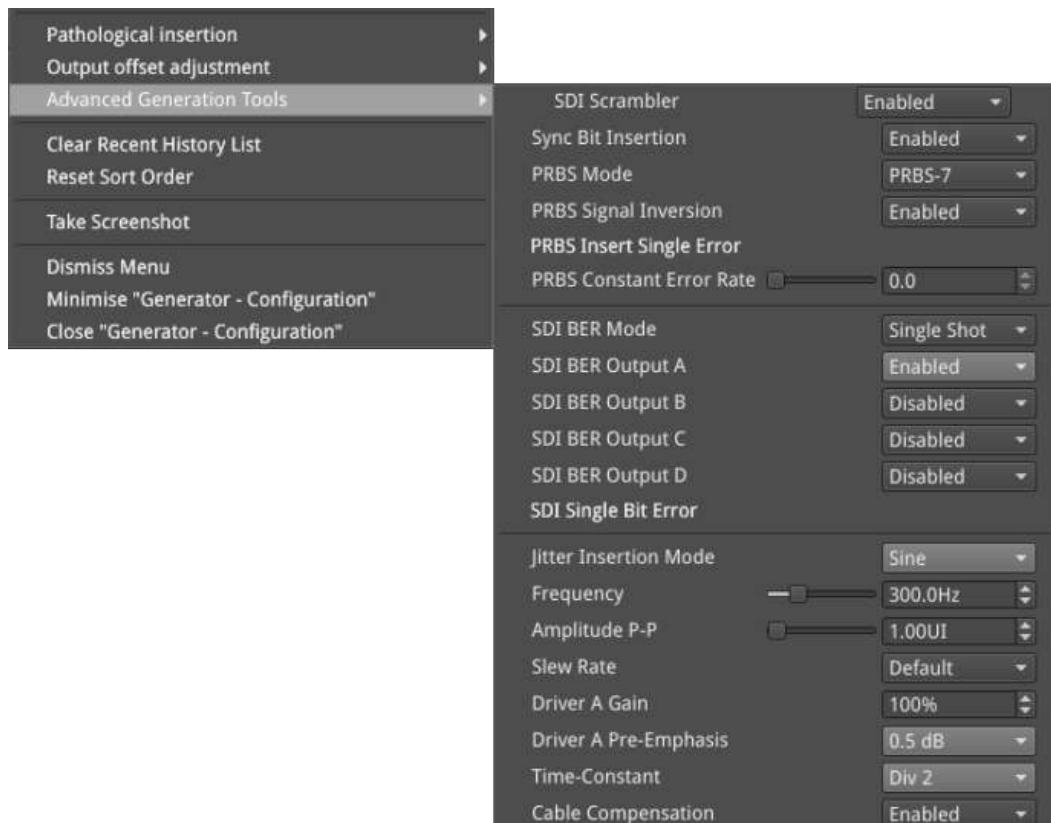

Figure 14-1: Advanced Generation Tools Option Menu (Optional SDI Input)

Advanced Generation Tools Options

The optional Advanced Generation Tools provide the following:

Table 14-1 : Advanced Generator Tools - Menu Options

Item	Options	Description
SDI Scrambler Options		
SDI Scrambler	Enabled (Default) Disabled	The selected video standard datastream can be made to bypass the SMPTE scrambler, just before the output stage. To bypass the scrambler, select Disabled . Note: . For the generation of conventional video, the default state for the SDI Scrambler is Enabled .
Sync Bit Insertion (6G / 12G) Options		
Sync Bit Insertion	Enabled (Default) Disabled	Sync bit insertion prevents the occurrence of a pathological condition that results in the removal of sync bits, also referred to as <i>potholing</i> . Before the output, a sync bit is applied to the Timing Reference Signal (TRS) and Ancillary Data Flag (ADF) words of the generated video standard. To prevent sync bit insertion, deactivate this feature by selecting Disabled . You can observe the insertion of the sync bit in the video signal TRS and ADF words seen in the Analyzer - Dataview instrument when the option Sync Bit Removal is disabled. Note: This feature applies only to 6G- and 12G-SDI video standards.
PRBS Mode Options		
PRBS Mode	Disabled (Default) PRBS-7 PRBS-9 PRBS-15 PRBS-23 PRBS-31	In addition to SDI test signal generation, for the stress testing of SDI infrastructure the unit offers end-to-end BERT capability, with the addition of pseudorandom bit sequence (PRBS) generation and analysis tools. When enabled, you can generate a variety of PRBS signals of different bit lengths. PRBS signal analysis is available in the instrument PRBS – Analysis . Note: The Generator instrument indicates when a PRBS signal is being generated.
PRBS Signal Inversion	Enabled Disabled (Default)	When enabled, inverts the PRBS signal.
PRBS Insert Single Error	System Control	When selected, inserts a single PRBS error at that point in the generated standard signal.
PRBS Constant Error Rate	System Control Slider at 0.0/Day (Default)	Set constant error rate between 10.0/day (minimum) and 9.2/sec (maximum). The rate can be defined as a number of errors introduced per day, hour, minute or second.
SDI BER Mode Options		

Item	Options	Description
SDI BER Mode	Disabled (Default) Single Shot Constant BER	The SDI BER Mode function enables you to insert an SDI error to test CRC and CS errors. A bit error is inserted at the appointed time and can affect any word in the current frame (or field) of the SDI flow. Consequently, ANC words, video words and audio words can all potentially be affected. Select either mode Single Shot or Constant BER to activate SDI BER Mode and display additional parameters.
SDI BER Output A	Disabled (Default) Enabled	Select SDI Out A as the target channel for insertion of the single bit error or constant BER.
SDI BER Output B	Disabled (Default) Enabled	Select SDI Out B as the target channel for insertion of the single bit error or constant BER.
SDI BER Output C	Disabled (Default) Enabled	Select SDI Out C as the target channel for insertion of the single bit error or constant BER.
SDI BER Output D	Disabled (Default) Enabled	Select SDI Out D as the target channel for insertion of the single bit error or constant BER.
SDI Single Bit Error	System Control	When selected, inserts a single bit error at that point in the generated standard signal.
SDI BER Interval	System Control Slider at 4295.0ms (Default)	Use the slider to set the time interval at which the bit errors are inserted. The unit will insert bit errors as long as the SDI BER Mode is set to Constant BER. Range: 10 ns to 10,000 ms
Jitter Insertion Mode Options		
Jitter Insertion Mode	Disabled (Default) Sine	In order to stress the interface and ensure that receivers comply with SMPTE recommended practice you can insert jitter into any generated SDI signal. You can insert sinusoidal jitter with a frequency ranging from 10 Hz to 10 MHz and adjust the peak-to-peak jitter amplitude.
Frequency	System Control Slider at 300.0Hz (Default)	When active, adjust the frequency of the sinusoidal jitter between 1.0 Hz and 10.0 MHz. Note: For precise setting adjustment and frequencies below 10 Hz use the up / down arrow buttons or input values using a USB keyboard.
Amplitude P-P	System Control Slider at 1.00UI (Default)	Jitter amplitude is measured in terms of signal Eye Unit Interval (UI). When active, adjust peak-to-peak jitter amplitude between 0.01 to 127.99 UI, depending on the jitter frequency. Caution: SDI outputs B, C and D may be corrupted when jitter is inserted.
Slew Rate Options		
Slew Rate	Default (Default) Slow Fast	Adjust the slew rate of the generated signal from its default setting. <ul style="list-style-type: none"> • Fast is the standard slew rate for 12G signals. • Slow (10% slower than Fast) is the standard slew rate for HD, 3G, and 6G signals. • Default automatically provides the standard slew rate for any signal being generated.

Item	Options	Description
		If required, you can select a slower slew rate for 12G signals or a faster slew rate for HD, 3G, and 6G signals.
Driver Output Control Options		
Driver A Gain	For units fitted with an optional mezzanine board version 14 or above: Default: 100% Gain is adjustable between 85 and 115% . For units with an optional mezzanine board number less than 14: Default: 100% Gain range is adjustable between 90 and 110% .	You can increase or decrease the signal gain of SDI Out A by up to 15 % in increments of 1%. The version of the optional mezzanine board (if fitted) is displayed in the About dialog. Note: Units upgraded from software release 2.3 or earlier will first require Driver A calibration. For instructions on driver calibration, see the section Driver Calibration .
Driver A Pre-Emphasis	Disabled (Default) 0.5 dB 1.0 dB 1.5 dB	You can adjust driver pre-emphasis for SDI Out A to boost the signal at the beginning of the rising edge of the eye pattern to optimize signal integrity. For more information on the Eye pattern display, see the section Eye - SDI In A (SDI Stress) .
Time-Constant	Default (Default) Div 2 Div 4 Div 8	With Driver Pre-Emphasis enabled, the pre-emphasis time constant can be left as default, or divided by 2, 4, or 8 to adjust the length of time the signal is boosted:
Cable Compensation Options		
Cable Compensation	Disabled Enabled (Default)	By default the unit compensates for the attenuation across a one meter length of SDI cable to ensure that the Eye amplitude at the end of the 1 m cable meets the SMPTE standard of 800 mV. If required, you can use the Cable Compensation option to disable the default attenuation compensation.

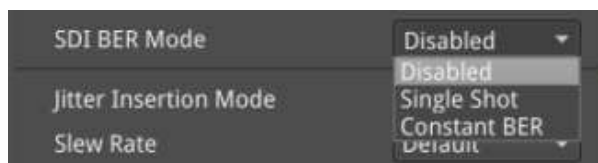

Figure 14-2: Advanced Generation Tools - SDI BER Mode Options

Note: Jitter can be observed in the [Eye – SDI In A](#) and [Jitter – SDI In A](#) instrument windows. For analysis, apply filters and other settings in the Eye and Jitter instruments as required.

Eye - SDI In A (Optional SDI Input - Stress Option)



Requires Option(s):	PHQXL01E-3G, PHQXLO-GEN and PHQXLO-SDI-STRESS
---------------------	---

Overview

The optional instrument **Eye - SDI in A**, available in the **Stress Testing Analysis** toolset, provides additional tools for stress testing and R&D evaluations of your SDI interfaces from 270 Mbps to 12 Gbps (optional). An analog front-end supplies a bandwidth of more than 30 GHz (5th harmonic of the 6 GHz fundamental for 12G-SDI.) The GUI uses PHABRIX RealTime Eye (RTE™) to generate a reliable, AC-coupled, instantaneous physical layer display with automatic measurements to SMPTE standards.

You can receive accurate measurements within seconds of connecting an SDI input. The unit enables you to measure both rise and fall overshoot at the top and bottom of the waveform. In addition, the unit displays amplitude, rise and fall overshoot delta and DC offset - all compulsory measurements when testing against SMPTE standards. The unit highlights any measurements exceeding the specification (for example, an eye amplitude greater than 10 %) in red.

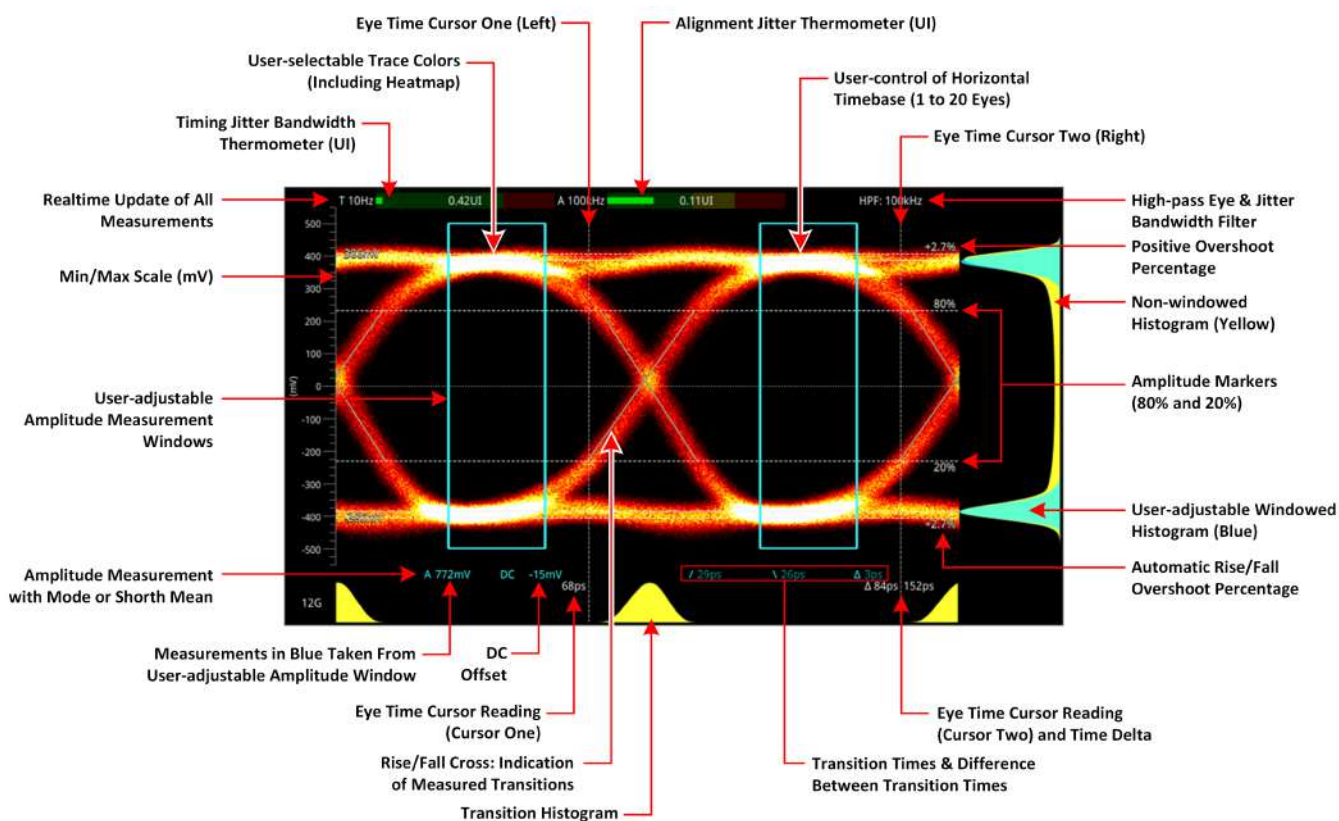

Figure 14-3: 12G-SDI Eye Pattern Display with 100 kHz Jitter Filter (Optional SDI Input)

Use the eye amplitude histogram, showing the distribution of samples over the complete visible eye waveform, to calculate the automatic eye amplitude measurement. The default analysis method is **Mode**.

Note: A black (or red) nut fitted to the **SDI In A** BNC identifies the connector with access to the eye and jitter circuitry.

Note: The use of SDI SFP inputs with **Eye - SDI In A** is not supported.

The **Eye - SDI In A** instrument display also provides:

- Timing jitter thermometer color-coded according to the analyzed SDI standard
- Alignment jitter thermometer color-coded according to the analyzed SDI standard
- Positive and negative Eye amplitude values
- On screen indication of 20 % and 80 % levels for rise and fall time measurement
- Horizontal time histogram of eye crossing point (0 mV threshold)
- Vertical amplitude histogram indicating energy distribution across all samples
- Eye coupled to AC with display of DC offset measurement
- A pair of vertical Eye time cursors to generate and display time measurements across the Eye display.

Using the Eye Time Cursors

When enabled, the Eye time cursors are displayed as a pair of vertical dashed lines, when static.

You can choose to position the Eye time cursors independently or link the cursors together so that they move as a single unit with a fixed time separation. In addition, cursor readings below the trace display the time measurements in picoseconds (ps) from the start of the trace, and show the delta between the two cursors.

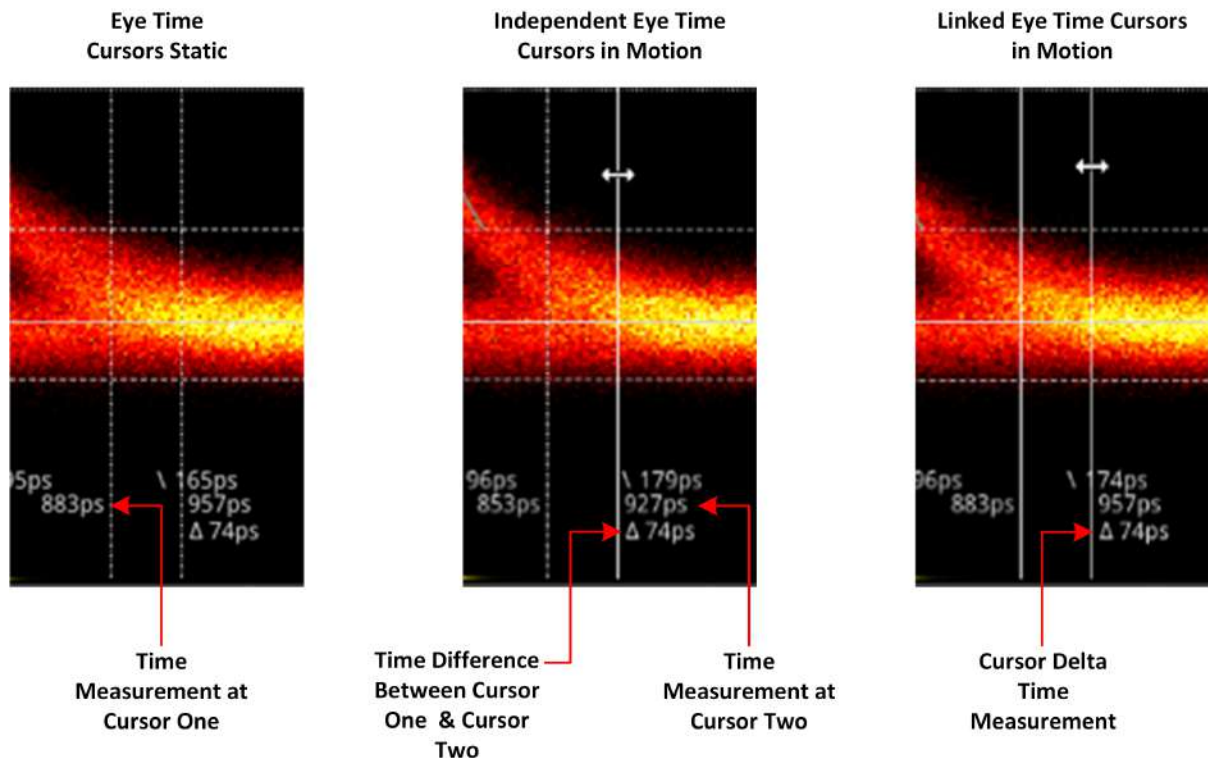

Figure 14-4: Advanced SDI Stress Option: Eye Time Cursors (Optional SDI Input)

You can use the mouse connected to the unit to click then drag a cursor or both cursors to a new position. When in motion, the dashed line of the cursor changes to a solid white line for improved visibility. You will see the time measurements below the Eye change in real-time as you adjust the cursor(s).

However, if using remotely, use the **Cursor One** and **Cursor Two / Cursor Delta** fields in the Instrument submenu to adjust the time cursor positions.

Instrument Menu Options

The Stress Testing toolset provides the following options in the right-click submenu.

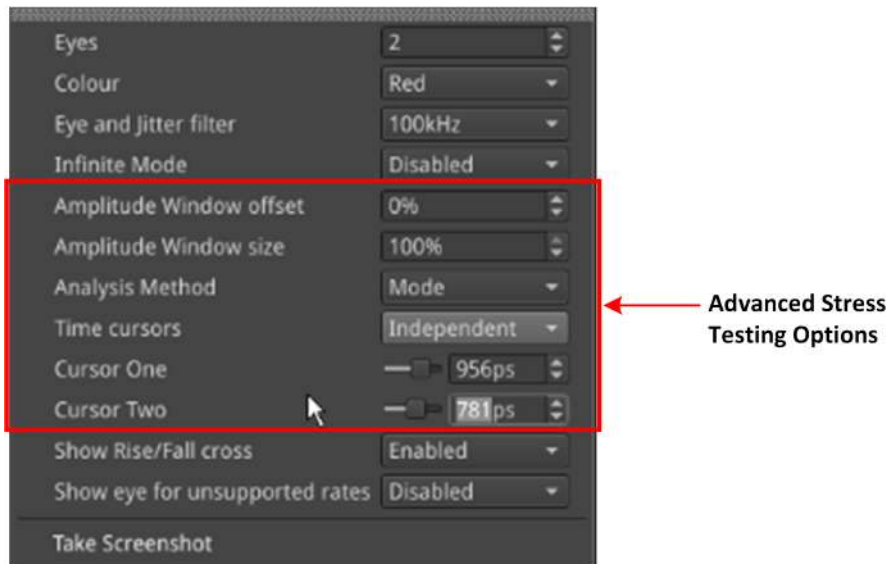

Figure 14-5: Eye - SDI In A Menu Showing Advanced Stress Testing Options

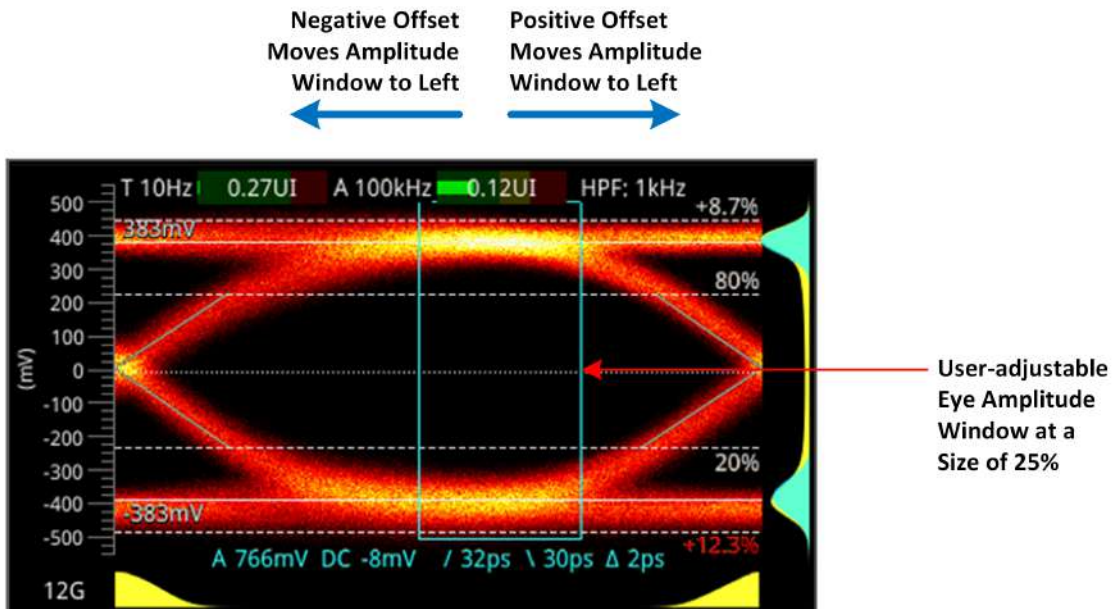

Figure 14-6: Advanced SDI Stress Option: Amplitude Window (Optional SDI Input)

The following table lists the configurable parameters for the Eye - SDI In A Instrument for optional SDI input, with the SDI Stress option (**PHQXO-SDI-STRESS**).

Table 14-2 : Menu Options for the Eye - SDI In A Instrument (Optional SDI Input)

Item	Options	Description
Standard Physical Layer Analysis Tools		
Eyes	1 to 20 (Default = 2)	Sets the default number of eyes displayed in the Instrument window.
Color	Green Heat Red Ferrara Green-red Blacklight	Sets the color scheme for the eye display.
Eye and Jitter Filter	10 Hz 100 Hz 1 kHz 10 kHz 100 kHz	Sets the frequency of the default jitter filter. Note: This setting controls the filter applied both to the Eye - SDI In A instrument and the Jitter - SDI A instrument.
Infinite Mode	Disabled (Default) Enabled	When disabled, eye data points are displayed for a fixed persistence interval and then removed from the display. When enabled, infinite mode ensures that no data points are removed from the eye display over time, so you will probably observe the eye shape thickening and becoming less distinct. This can be useful when attempting to identify anomalies in the signal which appear sporadically over time and might be missed in the standard mode.
Show Rise / Fall Cross	Disabled (Default) Enabled	Toggle the display of the rise/fall crossing point, which gives a visual indication of the rise and fall time measurements.
Show eye for unsupported rates	Disabled (Default) Enabled	Toggle the display of eyes for rates currently unsupported by the unit. Note: This setting is transient, enabling support of officially unsupported rates. The setting reverts to default following a reboot.
Stress Option: Amplitude Window		
Amplitude Window	The Amplitude Window, available in the Advanced SDI Stress Testing toolset, is an additional tool for more detailed analysis and measurement of the eye amplitude.	
Amplitude Window offset	-49 to 50% 0% Default	Only active when the amplitude window size is set to any value between 0 and 99%. Use the offset to move the Amplitude window to an optimum position on the eye for your measurement. A negative offset moves the window to the left and a positive offset, to the right.
Amplitude Window size	1 to 100% 100% (Default)	The amplitude window is defined by the enclosed area containing the eye data points used for eye amplitude measurements. All samples in the window area are used in the amplitude histogram measurement. You can use this option to define a window to focus on a specific part of the eye on which to take the amplitude measurements. When the size is set to the default 100%,

Item	Options	Description
		<p>the amplitude window is the entire active window of the Instrument.</p> <p>The size percentage relates to the percentage width of a single eye, so when set to 50% the Amplitude window covers 50% of an eye width and so on.</p>
Stress Option: Analysis Method		
Analysis Method	Mode (Default) Shorth Mean	Switches the statistical analysis method used for the eye amplitude data. Select between either standard Mode analysis or Shorth Mean analysis.
Stress Option: Eye Time Cursors		
Time Cursors	Independent Linked Disabled (Default)	<p>When selected, the Independent option allows you to move the two cursors independently of each other.</p> <p>When selected, the Linked option allows you to move both cursors together, separated by a fixed time delta. You can increase or decrease the separation by adjusting the Cursor Delta setting (see below).</p>
Cursor One	Slider and incremental combo box	Use the slider or combo box to move the left-hand cursor (when set to Independent) or both cursors (when set to Linked) across the Eye display. Increase the time (in ps) to move to the right or decrease to move to the left. When set to Independent, you will see the delta measurement between the two cursors increase or decrease. The left hand y-axis is equivalent to 0 ps.
Cursor Two (Independent Cursors)	Slider and incremental combo box	Use the slider or combo box to move the right-hand cursor across the Eye display. Increase the time (in ps) to move to the right or decrease to move to the left. You will see the delta measurement between the two cursors increase or decrease. The left hand y-axis is equivalent to 0 ps.
Cursor Delta (Linked Cursors)	Slider and incremental combo box	Use the slider or combo box to adjust the separation between linked cursors across the Eye display. Increase the time (in ps) to increase the separation or decrease to reduce the separation. You will see that the delta measurement between the two cursors remains constant as you position the two cursors as a single unit. The left hand y-axis is equivalent to 0 ps.

A table showing the SMPTE tolerances for each standard is provided in the section [SMPTE UHD TV: SDI Physical Layer Tolerances](#).

PRBS Analysis

(Optional SDI Input - Stress Option)



Requires Option(s):	PHQXL01E-3G, PHQXLO-GEN and PHQXLO-SDI-STRESS
---------------------	---

Overview

The **PRBS - Analysis** instrument displays the signal details, PRBS detection status, total amount of received pseudorandom binary sequence (PRBS) data, total number of errors, bit error rate (BER) per second, and OK time (since last error), for each SDI input link (BNC or SFP) on the unit.

PRBS - Analysis		PRBS-7			
Analysis time: 1m 13s					
	BNC SDI In A	BNC SDI In B	BNC SDI In C	BNC SDI In D	
Signal	1.5G	No Signal	No Signal	No Signal	
PRBS Detected	Detected	Not Detected	Not Detected	Not Detected	
Total Rx (Gb)	51	0	0	0	
Total Errors	1	0	0	0	
Bit error rate (/s)	7.2343e-10	0	0	0	
OK Time	29s				

Figure 14-7: PRBS - Analysis

Instrument Menu Options

The following table lists the configurable parameters in the PRBS - Analysis instrument options menu:

Table 14-3 : PRBS - Analysis Menu Options

Item	Options	Description
PRBS auto scan mode	Enabled Disabled (Default)	For SDI BNC inputs only, automatic PRBS analysis is available. By enabling auto scan mode, the unit will automatically cycle once through all available PRBS Analysis modes and select the correct mode for the incoming signal type. Once auto scan is complete, the function is automatically disabled.
PRBS Analysis Mode	Disabled (Default) PRBS-7 PRBS-9 PRBS-15 PRBS-23 PRBS-31	For BNC and SDI SFP inputs, you can manually enable PRBS analysis. When enabled, you can select the incoming PRBS signal type, if known.
PRBS Data Rate / Divisor	None (Default) Rate: 1G5 Divisor: 1000 Rate: 1G5 Divisor: 1001	For PRBS analysis on SDI SFP inputs this parameter enables you to ensure the accuracy of the PRBS analysis by selecting the appropriate signal data rate and divisor.

Item	Options	Description
	Rate: 3G Divisor: 1000 Rate: 3G Divisor: 1001 Rate: 6G Divisor: 1000 Rate: 6G Divisor: 1001 Rate: 12G Divisor: 1000 Rate: 12G Divisor: 1001	
PRBS Signal Inversion	Enabled Disabled (Default)	When enabled, inverts the incoming PRBS signal.
Reset	N/A Active Control	Resets the counts in the PRBS analysis table.

Note: To select a PRBS signal generation mode, launch the **Generator - Configuration** instrument and open the Options menu from the **Generate - Video** tab. Select the option **Advanced Generation Tools**, then select the desired **PRBS Mode** from the dropdown list.

The optional **Advanced Generation Tools** are available for optional SDI input with the SDI Stress option (**PHQXLO-SDI-STRESS**).

HDR Analysis Instruments

Note: This option requires the Advanced High Dynamic Range (HDR) License: **PHQXLO-HDR**.

This chapter describes the Instruments available with the High Dynamic Range (HDR) Toolset option and includes the following sections:

- [Advanced HDR Toolset](#)
- [Analyzer - CIE Chart](#)
- [HDR Heat-map \(False Color Overlay Tools\)](#)

Advanced HDR Toolset

Requires Option(s):	PHQXLO-HDR
---------------------	------------

Overview

The comprehensive advanced HDR toolset includes a signal generator for HDR test patterns, CIE chart Analyzer, Luma false color highlighting (or heat map), a waveform monitor and vectorscope. The HDR toolset supports all the main live production formats for both SDR and HDR.

For Standard Dynamic Range (SDR), the toolset supports:

- BT.709
- BT.2020

For High Dynamic Range (HDR), the toolset supports:

- BT.2100 HLG
- PQ
- Sony S-Log3
- Sony SR Live

The Waveform provides a Cd/m² (Nits) graticule along with BT.2048 diffuse white markers. The flexible user-controlled HDR heatmap highlights signals beyond SDR with seven simultaneous programmable color overlay bands with presets for HDR and SDR ranges, plus a user-definable preset. The CIE 1931 x,y display provides overlays for BT.709, BT.2020 and ST.2086 gamut (P3) to enhance the visualization and analysis of your HDR/WCG content.

An extensive set of test patterns include BT.2111 HDR color bars for HLG, PQ and SR Live as well as a full set of SDR 709 patterns mapped using *display light* to each of the four HDR formats for line checks, comparative monitor set-up and evaluation of HDR to SDR converters.

HDR Test Patterns

In addition to the standard SDR test patterns which are converted to HDR, the Advanced HDR toolset provides an additional two native HDR test patterns. These test patterns are available when you select one of the following HDR WCG (Wide Color Gamut) options from the **Gamut** and **OTF** lists in the **Video Generator Config...** dialog of the **Generator** Instrument:

- HDR HLG 2020
- HDR PQ 2020
- HDR S-Log3 2020
- HDR SR Live

The available test patterns for a selected video standard are displayed in the **Test Pattern** dialog accessed from options menu of the **Generator** instrument. The native HDR test patterns are as follows:



ITU-R BT.2111-0 HDR Color Bars



ITU-R BT.814-4 PLUGE – 4 variants

Figure 15-1: Available HDR Test Patterns

In addition, all other test patterns are converted to HDR in HDR mode, see the section [Generator Test Patterns](#) for a detailed list. Both S-Log3 and SR Live [S-Log3(HDR Live)] test pattern variants are available.

Transfer Curve and Colorimetry Overrides

HDR content may still contain the SMPTE payload ID for SDR and Rec.709 color space (as standard). When analyzing HDR and WCG content, therefore, you can select manual overrides in the configuration dialogs of the **Analyzer - Video Standard (SDI & 2022-6)** or **Analyzer - 2110 Format Setup** instruments for the appropriate HDR transfer curve and color space as follows:

- Transfer Curve Override, select: OTF: SDR, HLG, PQ, or S-Log3
- Colorimetry Override, select: Gamut: 709 or 2020

Analyzer - CIE Chart



Requires Option(s):	PHQXLO-HDR
---------------------	------------

Overview

The CIE 1931 x y chart provides a display of signal chromaticity - complete with Rec. 709, Rec. 2020, ST 2086 gamut overlays and the Illuminant D65 white point reference.

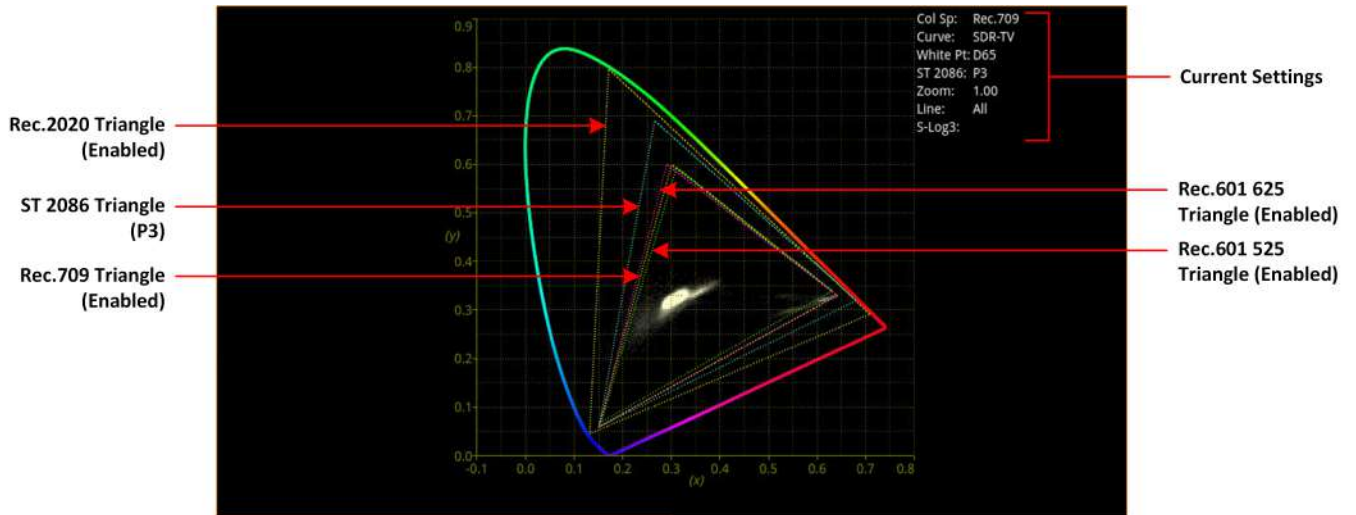

Figure 15-2: Analyzer - CIE Chart Instrument

Instrument Menu Options

The following table lists the configurable parameters in the Analyzer - CIE Chart instrument submenu:

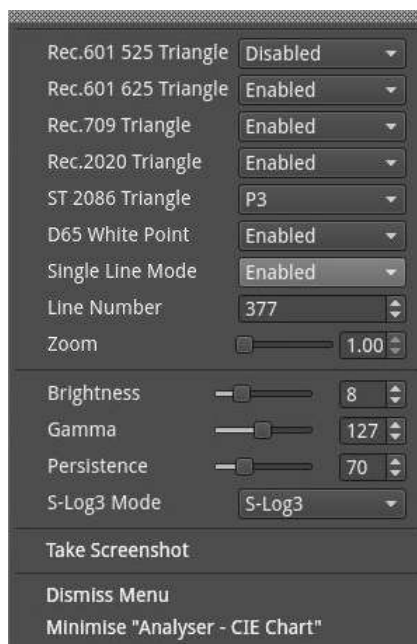

Figure 15-3: Analyzer - CIE Chart Options Menu

Table 15-1 : Analyzer - CIE Chart Options

Item	Options	Description
Rec.601 525 Triangle	Enabled Disabled (Default)	When enabled, displays the triangle for the Rec. 601 color primaries (525 line encoding).
Rec.601 625 Triangle	Enabled Disabled (Default)	When enabled, displays the triangle for the Rec. 601 color primaries (625 line encoding).
Rec.709 Triangle	Enabled (Default) Disabled	When enabled, displays the triangle for the Rec. 709 color primaries.
Rec.2020 Triangle	Enabled (Default) Disabled	When enabled, displays the triangle for the Rec. 2020 color primaries.
ST 2086 Triangle	P3 (Default) Disabled	This triangle shows the location of the SMPTE ST 2086 Mastering Display Primaries. Default is P3.
D65 White Point	Enabled (Default) Disabled	When enabled, displays a marker for the D65 white point in the CIE Chart.
Single Line Mode	Enabled Disabled (Default)	Enable single line mode analysis of the source.
Line Number	System Control 1 to Total number of active lines in the selected standard.	Total number of Active Lines for current standard
Zoom	Slider control; 1.00 (Default) to 4.00	Zoom in/out of the chart for detailed inspection. You can also zoom in/out of the chart by hovering the mouse crosshairs over the chart and scrolling the mouse wheel up or down.
x Position	Slider control;	Pan the zoomed image along the x-axis of the chart. You can also pan across the x-axis by hovering the mouse crosshairs over the x-axis and scrolling the mouse wheel up or down.
y Position	Slider control;	Pan the zoomed image along the y-axis of the chart. You can also pan across the y-axis by hovering the mouse crosshairs over the y-axis and scrolling the mouse wheel up or down.
Brightness	Slider control; 1 to 31 8 (Default)	Adjust the brightness of the instrument trace.
Gamma	Slider control; 1 to 255 127 (Default)	Adjust the gamma component of the instrument trace.
Persistence	Slider control; 1 to 255 70 (Default)	Adjust the persistence of the instrument trace.
S-Log3 Mode	S-Log3 (Default) SR Live	For HDR video signals, see the section Advanced HDR Toolset .

HDR Heat-map (False Color Overlay)

Requires Option(s):	PHQXLO-HDR
----------------------------	-------------------

A false color overlay can be applied to the image displayed in the **Picture** or **Picture -Copy** instrument to highlight luminance ranges in the image that are of particular interest, whether High Dynamic Range (HDR) or otherwise.

The picture can also be displayed in monochrome using grayscale shades. If enabled at the same time as False Color Highlighting, all image elements outside of the enabled false color overlay luminance range(s) are displayed in monochrome; leaving the false color highlight elements to stand out more.

Different types of false color overlay may be applied to visualize different image details clearly, and the custom mode is provided to enable you to create a modified or bespoke overlay.

The range(s) and colors of a selected false color overlay can be modified by adjusting the seven overlay bands. Up to seven distinct ranges can be simultaneously enabled in a single overlay. If adjusted, the new or modified overlay is designated as the Custom overlay type.

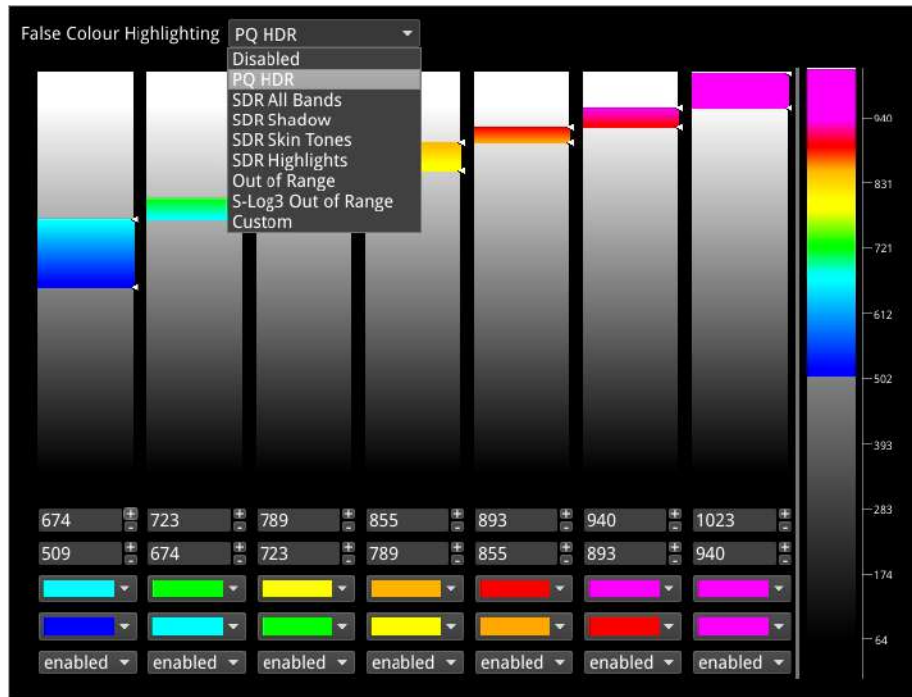

Figure 15-4: Configuring the False Color Overlay

When False Color Highlighting is enabled, a scale with numeric and graphic display of the luminance range(s) of the overlay in use, is available and the required luminance units for the scale can be selected.

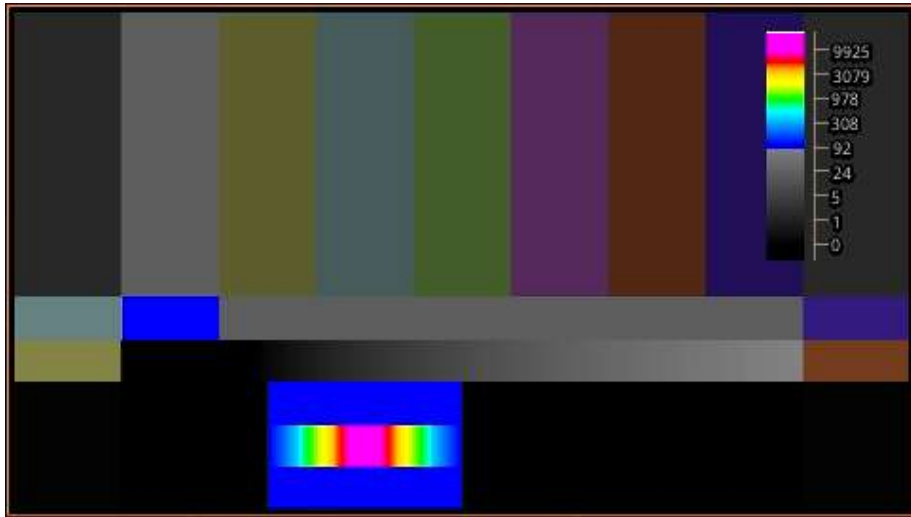

Figure 15-5: False Color Overlay Applied

HDR Instrument Options

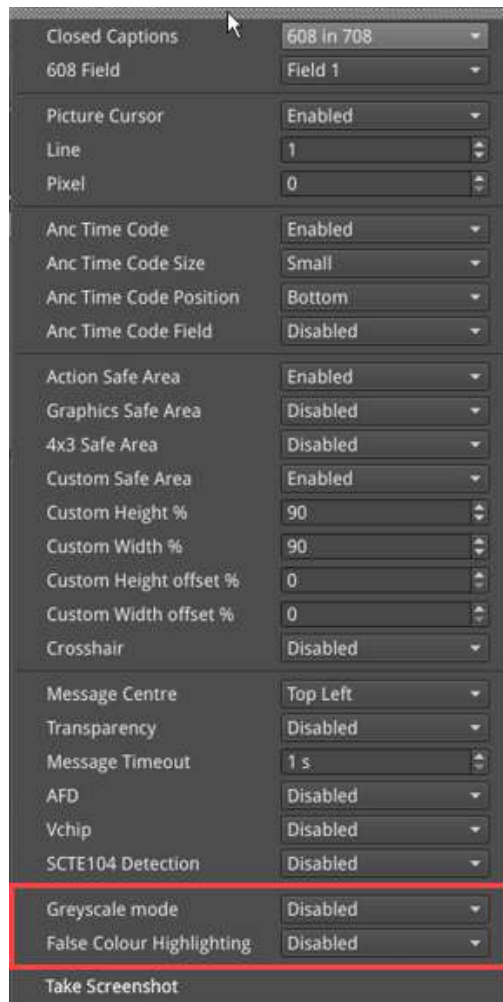

Figure 15-6: Analyzer - Picture Instrument Menu Showing HDR Options

The following table lists the options available with the Advanced HDR Toolset for the Analyzer - Picture and Analyzer - Picture Copy Instrument submenus:

Table 15-2 : HDR Menu Options for the Analyzer - Picture Instrument

Item	Options	Description
Grayscale Mode	Disabled (Default) Enabled	When enabled, displays the Picture using grayscale shades rather than color.
False Color Overlay Scale	Disabled (Default) Enabled	When active, displays a scale, showing both numeric and graphic representation of the luminance range(s) of the selected overlay, at the left-hand side of the window.
Luminance Measurement	Decimal Level (Default) PQ Nits	Selects the measurement units for luminance used in false color highlighting.
False Color Ranges	Disabled, PQ HDR, SDR All Bands, SDR Shadow, SDR Skin Tones, SDR Highlights, Out of Range, S-Log3 Out of Range, Custom	Opens False Color Highlighting window. Adjust any of the seven overlay bands to modify the range(s) and colors of a selected false color overlay. You can enable up to seven distinct ranges simultaneously in a single overlay. If adjusted, the new or modified overlay is designated as the Custom overlay type.

Additional System Information

This chapter provides additional information on using the REST API and driver calibration. It includes the following sections:

- [Using the REST API for Remote Access](#)
- [Using REST API Requests](#)
- [Using the Advertise NMOS Control Endpoints Toggle Switches](#)
- [Driver Calibration](#)

Using the REST API for Remote Access

You can use a standard REST API Client to interrogate the unit remotely by requesting data and status information, or to submit operational control commands.

Activating the REST API

Activate the REST API on the unit as follows:

1. Open the instrument: **Qx Network & Automation**.
2. Right-click in the window to open the submenu.
3. Enable the option: **REST API**.

When enabled, the REST API status in the Qx Network & Automation window displays the port number (8080) on which the unit is listening.

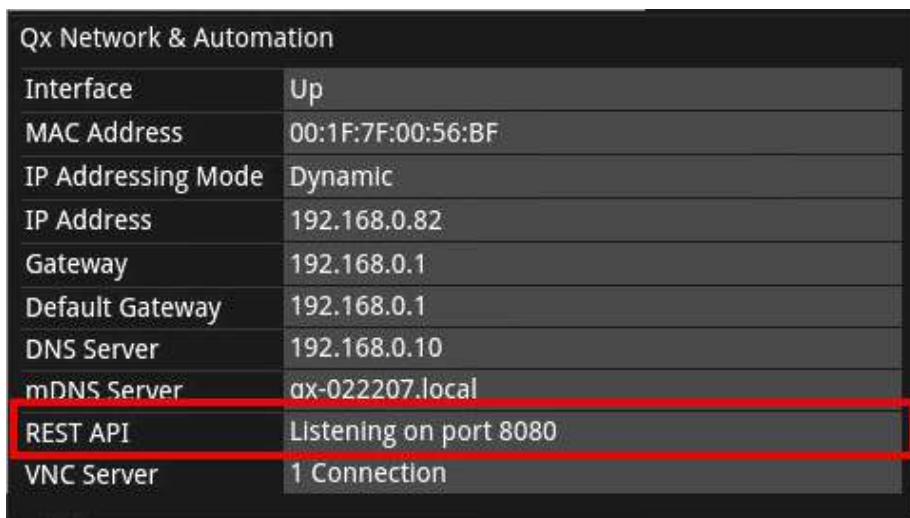

Qx Network & Automation	
Interface	Up
MAC Address	00:1F:7F:00:56:BF
IP Addressing Mode	Dynamic
IP Address	192.168.0.82
Gateway	192.168.0.1
Default Gateway	192.168.0.1
DNS Server	192.168.0.10
mDNS Server	qx-022207.local
REST API	Listening on port 8080
VNC Server	1 Connection

Figure 16-1: REST API Enabled in Network & Automation Window

Connecting Using the REST API

Connect to the unit using the REST API as follows:

1. Run your chosen REST API client application on the computer you will use to connect to the unit.
2. Use either the IP Address or mDNS Hostname (if mDNS is enabled on your computer) of the target unit, together with the port number, to connect to the unit.

For example, to submit a GET request, enter the specific IP Address or mDNS Hostname of the target unit, in one of the following formats:

- **http://192.168.0.70:8080/api**
- **http://qx-020094.local:8080/api**

See the section [Using REST API Requests](#) for an overview of the GET and PUT requests for the REST API.

You can script the following REST API requests for use in automated testing:

- PUT
- GET

- DELETE
- POST

Contact PHABRIX for full details of all available REST API requests.

Using REST API Requests

Using REST API Requests with ST 2022-6 IP Input

With ST 2022-6 IP input you can use REST API requests to:

- Report the currently active multicast request (GET):
 - **http://192.168.0.142:8080/api/v1/ipReceive/multicastRequests**
- Request a new multicast (PUT):
 - **http://192.168.0.142:8080/api/v1/ipReceive/multicastRequests**
 - With a raw payload of the form:
 - **{"action":"request","destinationIpAddress":"230.0.0.15"}**
 - In this example, to join a multicast group of destination IP address: 230.0.0.15
- Report the list of currently available IP media streams (GET):
 - **http://192.168.0.142:8080/api/v1/ipReceive/mediaStreams**
- Select the IP media stream for analysis (PUT):
 - **http://192.168.0.142:8080/api/v1/ipReceive/mediaStreams**
 - With a raw payload of the form:
 - **{"action":"analyseStream","destinationIpAddress": "230.0.0.15", \ "destinationUdpPort":16,"matchSrc":true,"sourceIpAddress": "192.168.10.30",\ "sourceUdpPort":16,"ssrc":123456}**
- Report the IP media stream currently being analyzed (GET):
 - **http://192.168.0.142:8080/api/v1/ipReceive/requestedMediaStreams**
- Clear the list of IP media streams (PUT):
 - **http://192.168.0.142:8080/api/v1/ipReceive/mediaStreams**
 - With a raw payload of:
 - **{"action":"clearList"}**

Using REST API Requests with ST 2110 IP Input

With ST 2110 IP input you can use REST API requests to:

- Report the currently active multicast request (GET):
 - **http://192.168.0.142:8080/api/v1/2110/receive/multicastRequests**
- Request a new multicast (PUT):
 - **http://192.168.0.142:8080/api/v1/2110/receive/multicastRequests**
 - With a raw payload of the form:
 - **{"action":"request","destinationIpAddress":"230.0.0.15"}**
 - In this example, to join a multicast group of destination IP address: 230.0.0.15
- Report the list of currently available IP media streams (GET):
 - **http://192.168.0.142:8080/api/v1/2110/receive/mediaStreams**
- Select the IP media stream for analysis (PUT):
 - **http://192.168.0.142:8080/api/v1/2110/receive/mediaStreams**
 - With a raw payload of the form:
 - **{"action":"analyseStream","destinationIpAddress": "230.0.0.15", \ "destinationUdpPort":16,"matchSrc":true,"sourceIpAddress": "192.168.10.30", \ "sourceUdpPort":16,"ssrc":123456}**
- Report the IP media stream currently being analyzed (GET):
 - **http://192.168.0.142:8080/api/v1/2110/receive/requestedMediaStreams**
- Clear the list of IP media streams (PUT):
 - **http://192.168.0.142:8080/api/v1/2110/receive/mediaStreams**
 - With a raw payload of:
 - **{"action":"clearList"}**

Using REST API Requests with Optional SDI Input

The REST API request examples provided in this section for guidance use an example IP address (**192.168.0.142**) and the REST API Port (**8080**).

The target base resource for REST API requests is: **/api**.

The target base URL for requests (GET) is in the format:

- **http://192.168.0.142:8080/api** or
- **http://qx-020094.local:8080/api**

You can submit REST API requests to:

- Report the current analyzed standard (GET):
 - **http://192.168.0.142:8080/api/v1/analyser/status**
- Report the currently generated standard (GET):
 - **http://192.168.0.142:8080/api/v1/generator/status**
- Navigate through a list of available standards that can be generated (GET):
 - **http://192.168.0.142:8080/api/v1/generator/standards**
 - Select the required URL from the tree structure and use GET again to drill-down to the appropriate color format, bit depth, level, SDR or HDR format, and test pattern.
- Generate a specific standard (PUT) by drilling-down through the available listed items:
 - **http://192.168.0.142:8080/api/v1/generator/standards/1920x1080p60/\ YCbCr%3A422%3A10/3G_A_Rec.709/100%25%20Bars**
 - You can also add a pathological overlay, specifying its type and number of pairs by including a raw payload of, for example:
 - **{ "action": "start", "pathological": { "type": "CheckField", "pairs": 100 } }**
- Report the currently generated audio standard (GET):
 - **http://192.168.0.142:8080/api/v1/generator/audio**
- Audio generation (PUT):
 - **http://192.168.0.39:8080/api/v1/generator/audio**
 - Include a raw payload for QuickConfig of the structure, for example:
 - **{ "mode": "Fixed Tone", "quickConfig": { "gainType": "Fixed Levels", "gain": -10, "pitch": "E 3" } }**
 - For Custom config raw payload structure, refer to the GET request output structure.
- View instantaneous Eye readings (GET):
 - **http://192.168.0.142:8080/api/v1/eye/status**
- View instantaneous Jitter readings (GET):
 - **http://192.168.0.142:8080/api/v1/jitter/status**
- Retrieve the event logs (GET):
 - **http://192.168.0.142:8080/api/v1/eventlog/logs**
- Report current CRC analysis status (GET):
 - **http://192.168.0.142:8080/api/v1/analyser/crcSummary**

- Manage the event logs (PUT):
 - <http://192.168.0.142:8080/api/v1/eventlog/config/restApi>
 - With a raw payload of:
 - {"action":"enable"}
 - In this example, to enable REST API event logging.

Contact PHABRIX for full details of all available REST API requests.

Using the Advertise NMOS Control Endpoints Toggle Switches

The **Advertise NMOS control endpoints** toggle switches in the [NMOS Configuration](#) dialog are provided to prevent network interfaces being advertised in specific sections of the Node API **/self** and **/devices** resources. This is to allow users to control how NMOS controllers connect to the unit by advertising on which network addresses the Qx listens for IS-04 and IS-05 requests.

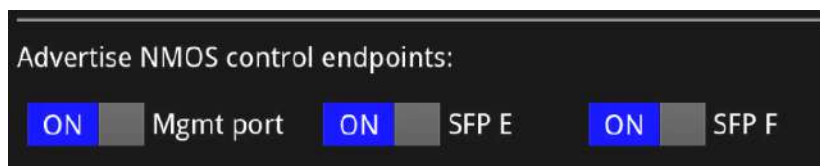

Figure 16-2: Toggle Switches to Advertise NMOS Control Endpoints in NMOS Configuration Dialog

For example, if a controller is connected only to the same network as the management port on the unit but cannot see the two networks to which the media interfaces on **SFP E** and **SFP F** are connected, you can disable NMOS control endpoint adverts on **SFP E** and **SFP F**. Otherwise, the controller may attempt to make requests to unreachable networks.

Note: These controls have no effect on the availability of Sender, Receiver, Flow or Source resources with respect to the media interfaces, nor do they affect which interfaces listen for NMOS requests - we may not advertise an interface but it will still be listening. Furthermore, these controls have no effect on multicast or unicast DNS-SD service discovery.

Affected NMOS Resources on the Unit: [/x-nmos/node/v1.3/self](#)

When the toggle switches are disabled, the unit will no longer add entries for those interfaces to the **api.endpoints** list in the **/self** Node resource. This list contains details of all the network addresses, ports (and protocols) on which the Node API listens for requests.

For example, a unit with three available network interfaces (management on 192.168.0.10, **SFP E** on 192.168.10.10 and **SFP F** on 192.168.20.10) if you disable the **SFP E** toggle switch, the **api.endpoints** list in the **/self** resource will contain:

```
{
  ..... "api": {
    ..... "endpoints": [
      ..... {
        ..... "host": "192.168.0.10",
        ..... "port": 3000,
        ..... "protocol": "http"
        ..... },
      ..... {
        ..... "host": "192.168.20.10",
        ..... "port": 3000,
        ..... "protocol": "http"
        ..... }
      ..... ],
      .....
    }
  }
}
```

Note: The **clocks** list and **interfaces** list in the **/self** resource are not affected by these toggle switches.

Affected NMOS Resources on the Unit: /x-nmos/node/v1.3/devices

When the toggle switches are disabled, the unit will no longer add entries for those interfaces to the **controls** list in the **/devices** resource (the first and only entry in the **/devices** resource). The **controls** list in the **/devices** resource contains a list of URLs used by the unit to listen for various protocol requests (the IS-05 connection API and the manifest-base API).

NMOS controllers use the entries in the **controls** list to determine how to use other NMOS protocols on the unit. By limiting these adverts you may avoid problems with controllers attempting to communicate with the unit on unreachable networks.

For example, a unit with three available network interfaces (management on 192.168.0.10, **SFP E** on 192.168.10.10 and **SFP F** on 192.168.20.10) if you disable the **SFP E** toggle switch, the **controls** list in the **/devices** resource will contain:

```
{
  ...."controls":.[
    .....{
    ..... "href": "http://192.168.0.10:3000/x-nmos/connection/v1.0",
    ..... "type": "urn:x-nmos:control:sr-ctrl/v1.0"
    .....},
    .....{
    ..... "href": "http://192.168.20.10:3000/x-nmos/connection/v1.0",
    ..... "type": "urn:x-nmos:control:sr-ctrl/v1.0"
    .....},
    .....{
    ..... "href": "http://192.168.0.10:3000/x-nmos/connection/v1.1",
    ..... "type": "urn:x-nmos:control:sr-ctrl/v1.1"
    .....},
    .....{
    ..... "href": "http://192.168.20.10:3000/x-nmos/connection/v1.1",
    ..... "type": "urn:x-nmos:control:sr-ctrl/v1.1"
    .....},
    .....{
    ..... "href": "http://192.168.0.10:3000/x-manifest/",
    ..... "type": "urn:x-nmos:control:manifest-base/v1.0"
    .....},
    .....{
    ..... "href": "http://192.168.20.10:3000/x-manifest/",
    ..... "type": "urn:x-nmos:control:manifest-base/v1.0"
    .....}
    ....],
  ...
}
```

Driver Calibration

Requires Option(s):	PHQXL01E-3G
---------------------	-------------

Overview

All PHABRIX units are calibrated and verified before dispatch. Over time, however, the optional SDI generator outputs of the unit may require recalibration as described in this section.

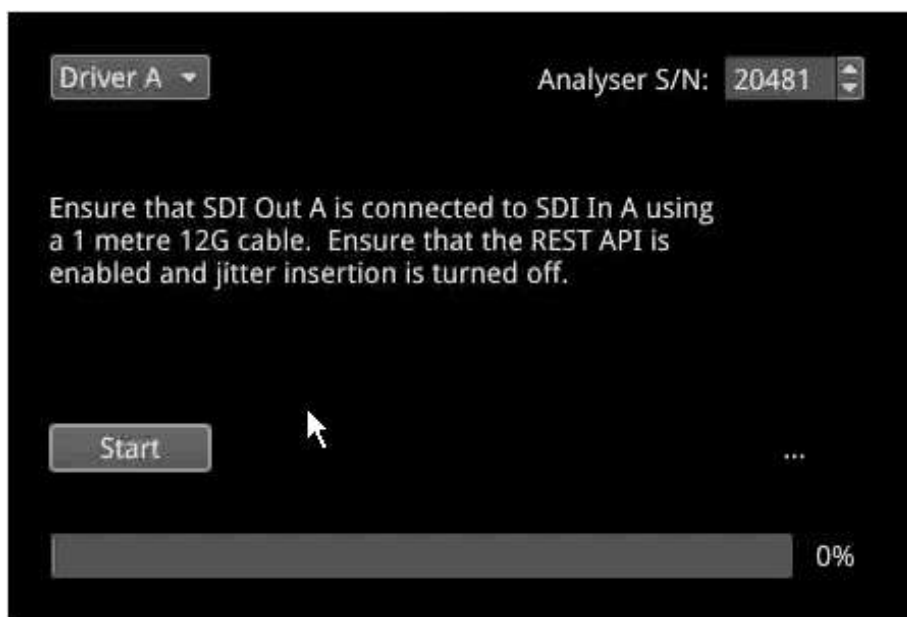

Figure 16-3: Driver Calibration Window

On units with PHABRIX RTE™ (RealTime Eye) capability, the optional SDI generator outputs of the unit can each be calibrated using the SDI In A input.

Note: Recalibration relies upon the calibration status of the Eye/Jitter analyzer. If in doubt consider returning the unit to PHABRIX for calibration.

SDI Output Calibration Steps

Warning: Before attempting to calibrate the unit, make sure that you use a 12G cable that complies with the specification described below. If in doubt, do not attempt to perform calibration on your unit.

Calibrate the unit as follows:

Note: If the unit includes the SDI Stress option (**PHQXLO-SDI-STRESS**) first disable **Jitter Insertion Mode** before beginning driver calibration. See the section [Advanced Generation Tools \(SDI Stress Mode\)](#) for further details.

1. Connect a one meter long cable between the SDI In A input (black or red nut) and the SDI output to be calibrated. A 12G-SDI grade or compatible cable with 12G-SDI BNCs must be used. A suitable cable type is Belden 1694A.

2. Open the **Instrument Launch Menu** and select: **System Settings > Driver Calibration** to open the calibration window.
3. Select the output to calibrate from the dropdown menu, for example, for SDI Output A, select Driver A and so on.
4. Click **Start** to begin calibration. It can take up to five minutes to calibrate an output.
5. On completion of calibration for SDI Output A, connect the output side of the cable to SDI Output B and repeat the steps above, until you have calibrated all SDI Outputs. It may take about 20 minutes to calibrate all four outputs.

Technical Specifications

This Appendix defines the technical specifications of your unit and includes the following sections:

- [Power](#)
- [External Locking Reference](#)
- [SDI Instrument Output](#)
- [HDMI Instrument Output](#)
- [USB Connectors](#)
- [Networking](#)
- [Rear Panel D26 Connector](#)
- [GPIO](#)
- [AES Input/Output](#)
- [Longitudinal Timecode \(LTC\)](#)
- [Analog Audio Output](#)

Technical Specifications

Power

Connector	4-pin XLR, Male
Voltage	10 - 18 V, 12 V DC nominal. DC Power adapter provided. Overvoltage, undervoltage and reverse voltage protection.
Power	50 W nominal, 70 W maximum.

Connector Pinouts Connector View from Rear of Unit (male):



- **Pin 1:** Screen Ground
- **Pin 2:** Not Connected
- **Pin 3:** Not Connected
- **Pin 4:** Core 12 V

External Locking Reference

Label	REF
Input Signal	Tri-level or Bi-Level (black burst) syncs 50 / 59.94 / 60 Hz
Connector	1 x Micro-HD BNC
Input Impedance	Unterminated; 75R Terminated
Input Return Loss	N/A
Maximum Input voltage	+/- 2 V
Specification	Tri-level syncs (SMPTE 274M and SMPTE 296M) 600 mV pk-pk PAL Black Burst (ITU 624-4/SMPTE 318) 1 V pk-pk, Composite NTSC (SMPTE 170M) 1 V pk-pk

SDI Instrument Output

Label	SDI OUT
Connector	Micro-HD BNC
Output Impedance	Unterminated; 75R Terminated
Output Level	800 mV p-p +/- 10 %
Purpose	3 Gbps SDI instrument output

HDMI Instrument Output

Label	HDMI
Connector	Type A version 1.4
Video Format	1920 x 1080 RGB 4:4:4

Audio Format 4 x PCM stereo audio at 48 kHz
 Purpose Monitor output that allows up to 16 individual instrument panels (or windows) to be displayed.

USB

USB USB 2
 USB Connector Type A
 Quantity 3 (2 x front-mounted, 1 x rear-mounted)
 Purpose Keyboard and mouse control of the HDMI® monitor output of instrument and software installation.

Networking

Ethernet IEEE 802.3 1000 Mb/s (1000 base-T)
 Ethernet Connector RJ-45

Rear panel D26

Label I/O Expansion
 Connector 26-way D-type
 Purpose 8 x GP I/O, 4 x AES I/O, LTC input, stereo analog audio out
 Pinout



Table A-1: D26 Connector Pin-outs

Pin Number	Pin Name	Description	Hardwired GPIO Assignments (ST 2110 IP I/O)	Hardwired GPIO Assignments (Non-ST 2110 IP I/O)
1	AES_IO1	Bidirectional AES I/O - 75 ohm unbalanced	N/A	N/A
2	AES_IO2	Bidirectional AES I/O - 75 ohm unbalanced	N/A	N/A
3	AES_IO3	Bidirectional AES I/O - 75 ohm unbalanced	N/A	N/A
4	AES_IO4	Bidirectional AES I/O - 75 ohm unbalanced	N/A	N/A
5	LTC_RX_P	LTC Receive (RX) P (RS-422 compatible)	N/A	N/A
6	LTC_RX_N	LTC Receive (RX) N (RS-422 compatible)	N/A	N/A
7	AUDIO_R	Audio Line Out - right	N/A	N/A
8	AUDIO_L	Audio Line Out - left	N/A	N/A
9	5V0_GPIO	5 V current limited GPIO supply (500 mA)	N/A	N/A
10, 11, 12, 13, 14, 15, 16, 17, 18	GND	0 V	N/A	N/A
19	GPIO-0	Open drain,	1 PPS output for the	Pathological signal

Pin Number	Pin Name	Description	Hardwired GPIO Assignments (ST 2110 IP I/O)	Hardwired GPIO Assignments (Non-ST 2110 IP I/O)
		10 kohm pull-up to + 5 V	selected PTP engine when System Reference set to PTP. Off when System Reference set to Free Run.	output on SDI A Pulses on detection of a PLL pathological condition.
20	GPIO-1	Open drain, 10 kohm pull-up to + 5 V	1 PPS for SFP E when PTP Engine is enabled; off when not enabled.	Pathological signal output on SDI A Pulses on detection of an Equalizer pathological condition.
21	GPIO-2	Open drain, 10 kohm pull-up to + 5 V	1 PPS for SFP F when PTP Engine is enabled; off when not enabled.	Pathological signal output on SDI B Pulses on detection of a PLL pathological condition.
22	GPIO-3	Open drain, 10 kohm pull-up to + 5 V	N/A	Pathological signal output on SDI B Pulses on detection of an Equalizer pathological condition.
23	GPIO-4	Open drain, 10 kohm pull-up to + 5 V	N/A	Pathological signal output on SDI C Pulses on detection of a PLL pathological condition.
24	GPIO-5	Open drain, 10 kohm pull-up to + 5 V	N/A	Pathological signal output on SDI C Pulses on detection of an Equalizer pathological condition.
25	GPIO-6	Open drain, 10 kohm pull-up to + 5 V	N/A	Pathological signal output on SDI D Pulses on detection of a PLL pathological condition.
26	GPIO-7	Open drain, 10 kohm pull-up to + 5 V	N/A	Pathological signal output on SDI D Pulses on detection of an Equalizer pathological condition.

GPIO

Connector	26-way D-type (see previous table)
Pins	19 (GPIO - 0), 20 (GPIO - 1), 21 (GPIO - 2), 22 (GPIO - 3), 23 (GPIO - 4), 24 (GPIO - 5), 25 (GPIO - 6), 26 (GPIO - 7)
Format	Open drain with 10 kohm pull-up to +5 Volts
Power	5 V (pin 9), current-limited GPIO supply for open drain input/outputs. 0 V / signal ground (pins 10 to 18)
Purpose	Generator Pathological Rate Detection

AES I/O

Connector	26-way D-type
Pins	1 (AES I/O 1), 2 (AES I/O 2), 3 (AES I/O 3), 4 (AES I/O 4)
Input Impedance	75 ohm terminated
Maximum Input voltage	+/- 2 V
Input Sample Rate	48 kHz synchronous audio
Input Bit Depth	20 bit or 24 bit
Output Sample Rate	48 kHz synchronous to system reference
Output Bit Depth	24 bit
Specification	Conforming to AES3-2003 and SMPTE-276M
Purpose	4 x AES I/O audio

Longitudinal Timecode (LTC)

Connector	26-way D-type
Pins	5 (RX - P), 6 (RX - N)
Format	RS-422 Compatible
Purpose	Not currently supported in software

Analog Audio Output

Connector	26-way D-type
Pins	7 (Audio Line Out - Right), 8 (Audio Line Out - Left)
Type	Stereo Pair
Level	(1 V peak-to-peak analog audio, full scale 0 dBFS)
Purpose	Audio Monitoring output

Advanced Media Timing Information

This Appendix provides additional information about the advanced media timing measurements you can make using the **Video Timing & System Reference** instrument and includes the following sections:

- [Overview](#)
- [Measurements in the Video Timing Tab](#)
- [Measurements in the Media Latency Tab](#)

Advanced Media Timing Measurements

Requires Option(s):	PHQXLO-IP-MEAS
---------------------	----------------

Overview

This appendix provides additional detail on the advanced media timing measurements available in the **Video Timing & System Reference** instrument when the **PHQXLO-IP-MEAS** license is installed. For information on using the Instrument, see the sections [Video Timing & Setting External Reference in IP 2110 Mode](#) and .

Advanced Media Timing Definitions

The following terms are used in this section and are defined as follows:

Table B-1 : Advanced Media Timing Definitions

Term	Definition
TPA_0	The PTP arrival time of the first packet of a frame, for progressive video, or field one, for interlaced video, as measured.
TPR_0	The time when the receiver is expected to read the packet from its receive buffer. It is set by TR_{Offset} which can be either the default value or set in the Session Description Protocol (SDP).
$N * T_{Frame}$	The Epoch-aligned start of the last frame as defined in ST 2059-1.
T_{VD}	A time-point at which $N * T_{Frame} + TR_{Offset}$ is an integer and the time-scale has its origin at the SMPTE Epoch as defined in SMPTE ST 2059-1.
$RTP_{Timestamp}$	The time contained in the timestamp within the received packet.

Video IP Packet Timing Schematics

The graphics on the following pages are provided to illustrate the subsequent descriptions of the advanced media timing measurements. The first, [Figure B-1](#), shows the IP video packet timing at the Sender and [Figure B-2](#) shows the IP video packet timing at the receiver.

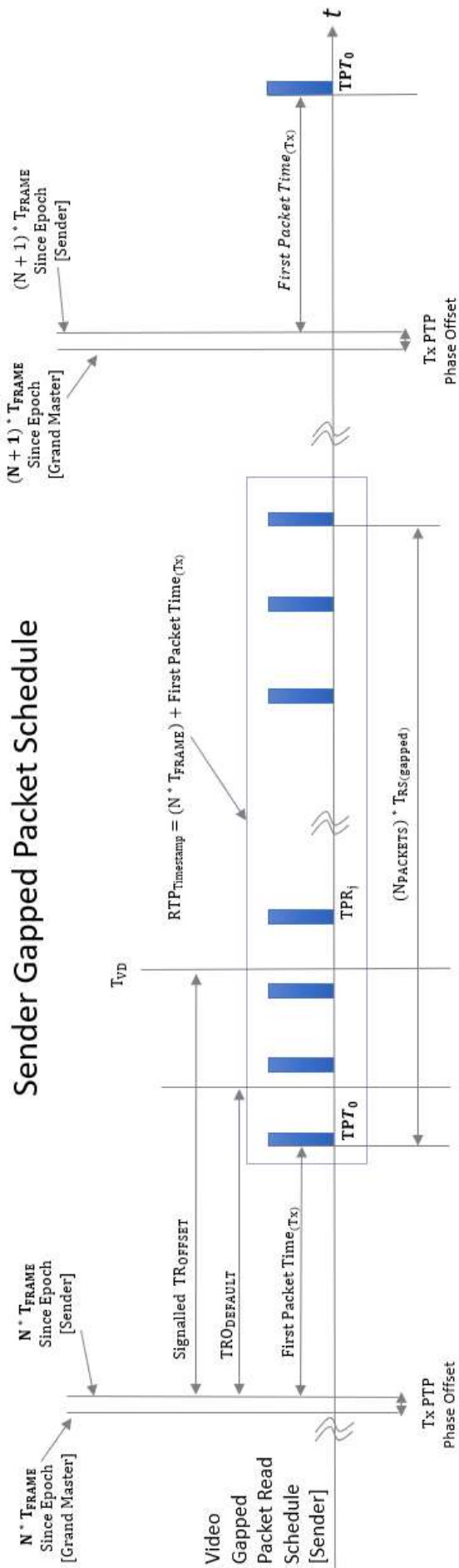

Figure B-1: Sender Gapped Packet Schedule

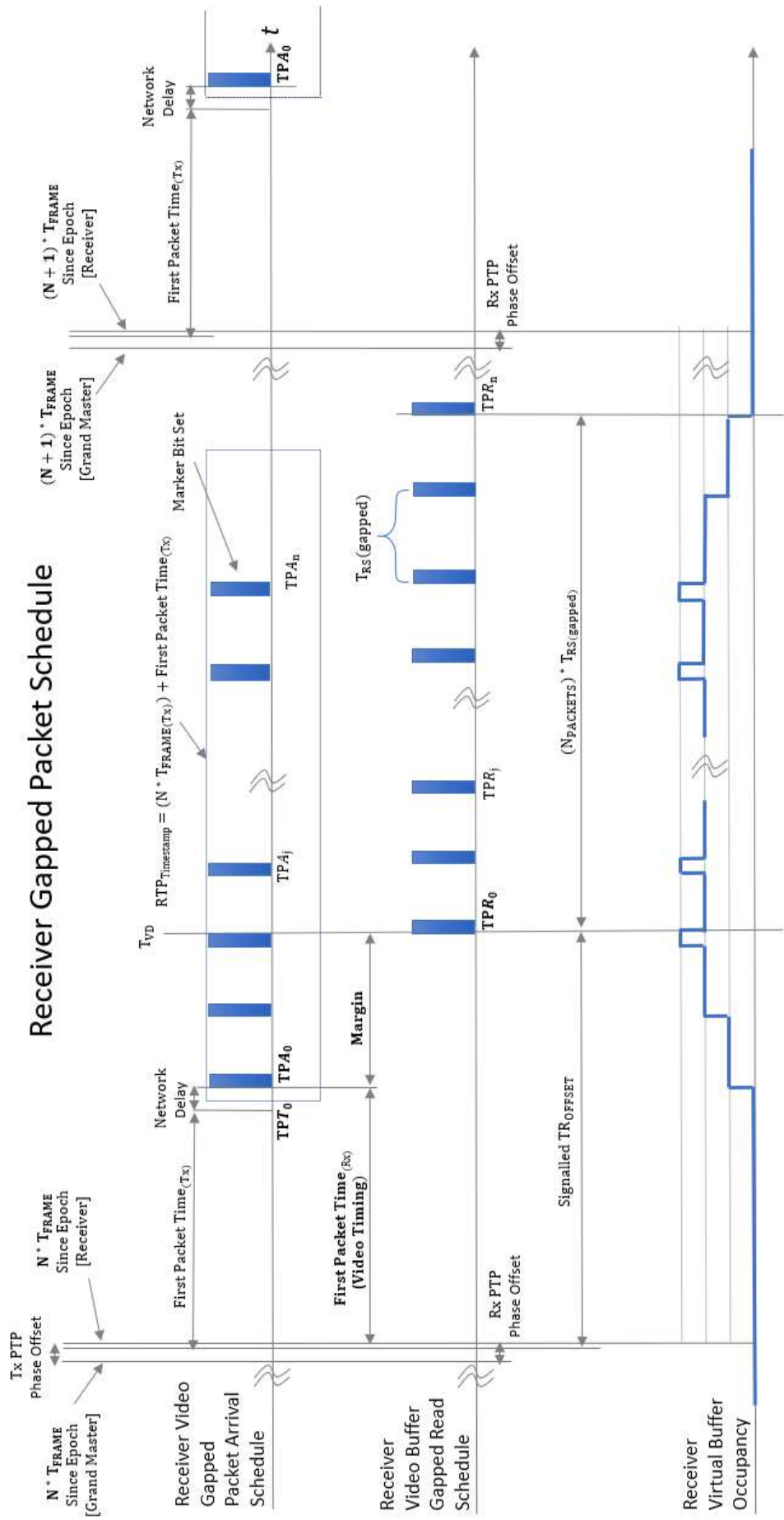

Figure B-2: Receiver Gapped Packet Schedule

Measurements in the Video Timing Tab

Video Timing (First Packet Time) Measurement

The **Video Timing** measurement is analogous to the SDI or Analog vertical interval timing measurement where the start of frame is measured with respect to an analog external reference. The unit calculates Video Timing as follows:

$$\text{Video Timing} = \text{TPA}_0 - N * T_{\text{Frame}} \text{ (averaged over 1 second)}$$

Where:

- **TPA₀** is the arrival PTP time of the first packet of a frame for progressive or field one for interlaced video as measured as measured by the unit
- **N * T_{Frame}** is the Epoch-aligned start of the last frame as defined in ST 2059-1, as reconstructed by the unit.

By default, the Video Timing value is always positive, however, if you enable the Wrap frame option in the submenu, the unit displays any values greater than half a TV frame period as negative values with respect to the next TV frame.

This measurement is affected by:

- The PTP Lock and Phase Offset of the Sender and unit (Receiver)
- The network propagation delay
- The timing relationship between the Source media Frame Sync and the PTP-derived Frame Sync
- The relationship of the underlying Media Clock to PTP, and whether the media is locked to PTP.

The unit measures Video Timing using the receiver time reference for the two sampling points and does not make use of RTP timestamps. Consequently, Video Timing can be measured with high precision as it is not quantized by source RTP clocks. The measurement uncertainty is a function of the hardware timestamp, which has a resolution of approximately 100 ns. The measurement varies with the unit's PTP estimated phase offset, and the PTP delay control.

SMPTE ST 2110-21 defines a nominal or ideal value of the sender's Video Timing (**TRO_{Default}**) for each video format as shown in the following table:

Table B-2 : SMPTE ST 2110-21 Nominal Sender's Video Timing TRO_{Default} by Video Format

Video Format	Frame Rate (F/s)	TRO _{Default} (μs)	TRO _{Default} Integer (μs)
525i	29.97002997	1271.111	1271
625i	25	1664.000	1664
720p	23.97602398	1557.111	1557
	24	1555.556	1556
	25	1493.333	1493
	29.97002997	1245.689	1246
	30	1244.444	1244
	47.95204795	778.556	779
	48	777.778	778

Video Format	Frame Rate (F/s)	TRO _{Default} (μ s)	TRO _{Default} Integer (μ s)
	50	746.667	747
	59.94005994	622.844	623
	60	622.222	622
<hr/>			
1080i	23.97602398	815.63	816
	24	814.815	815
	25	782.222	782
	29.97002997	652.504	653
	30	651.852	652
<hr/>			
1080p	23.97602398	1594.185	1594
	24	1592.593	1593
	25	1528.889	1529
	29.97002997	1275.348	1275
	30	1274.074	1274
	47.95.204795	797.093	797
	48	796.296	796
	50	764.444	764
	59.94005994	637.674	638
	60	637.037	637
<hr/>			
1080PsF	23.97602398	815.63	816
	24	814.815	815
	25	782.222	782
	29.97002997	652.504	653
	30	651.852	652
	47.95204795	407.815	408
	48	407.407	407
	50	391.111	391
	59.94005994	326.252	326
	60	325.926	326

Note: If the underlying Media Clock is not locked to PTP (for example, if it originates from an SDI player that cannot be generator locked (genlocked) being played through an SDI-to-2110 gateway) then the Video Timing measurement will have a value that is determined mainly by the video source to PTP timing relationship.

Note: If the source is not locked to PTP, then the value of the Video Timing measurement will drift continuously.

Margin Measurement

The **Margin** is the difference between the First Packet Time (video timing measurement) and the time of the first video buffer read in the receiver. The indicated **TR_{Offset}** is used to control the read schedule of the receiver buffer and the Margin is the amount of buffer pre-fill prior to the start of the buffer read process. The Margin is calculated as follows:

$$\text{Margin} = \text{TPA}_0 - (N * T_{\text{Frame}} + \text{TR}_{\text{Offset}}) = \text{First Packet Time} - \text{TR}_{\text{Offset}}$$

The Margin measurement will be affected by the following:

- **TR_{Offset}**
- The PTP Lock and Phase Offset of the Sender and unit (Receiver)
- The network propagation delay
- The timing relationship between the Source media Frame Sync and the PTP derived Frame Sync
- The relationship of the underlying Media Clock to PTP, and whether the media is locked to PTP.

The unit provides a facility to enter a manual value for the **TR_{Offset}** in the Instrument submenu. In the absence of a manual value of **TR_{Offset}** the unit will use the **TR_{Default}** value for that video format, see the table in [Measurements in the Video Timing Tab](#).

A negative value indicates that the packets are arriving earlier than expected for an idealized system, implying that the receiver has more time to buffer and consequently, has more margin.

A positive value indicates that the packets are arriving later than expected for an idealized system, and that the size of the available buffer is being reduced.

If the video phase of the source is adjusted so that the Margin is zero, then the measured Video Timing should then be equal to the **TR_{Offset}**.

Note: If the underlying Media Clock is not locked to PTP (for example, if it originates from an SDI player that cannot be genlocked being played through an SDI-to-2110 gateway) then the Margin measurement will have a value that is determined mainly by the video source to PTP timing relationship.

RTP Offset Measurement

This measurement is the difference between the time encoded in the RTP timestamp and the start of the frame for progressive or first field for interlaced since the epoch, averaged over 1 second. A camera will typically timestamp at the image capture instant. An SDI gateway will timestamp at the start of the frame, and a synthetic source can timestamp at the start of the frame or at the time the first packet egresses from the sender. For an SDI to ST 2110 gateway, when the source video timing has been adjusted to give a Video Timing measurement value that is equal to **TR_{Default}** (a Margin of zero), then the RTP Offset is an indication of the timing relationship of the source video to PTP. The RTP Offset is calculated as follows:

$$\text{RTP Offset} = \text{RTP}_{\text{Timestamp}} - N * T_{\text{Frame}} \text{ (averaged over 1 second)}$$

Where:

- **RTP_{Timestamp}** is the time contained in the timestamp within the received packet, created by the source
- **N * T_{Frame}** is the Epoch-aligned start of the last frame as defined in ST 2059-1 as reconstructed by the unit.

In principle, the RTP Offset measurement will be affected by:

- The PTP Lock and Phase Offset of the Sender and unit (Receiver)
- The relationship of the underlying Media Clock to PTP, and whether the media is locked to PTP.

The unit calculates the RTP Offset by subtracting the Video Latency measurement from the Video Timing measurement; a method that is insensitive to the PTP phase offset of the unit, and the PTP lock or phase of the source.

The PTP time of the **RTP_{Timestamp}** is limited by the resolution of the source RTP Media Clock. For ST 2110-20 Video this clock is 90 kHz and has a quantization of 11 μs. The true PTP time at which a packet is assembled in the sender output buffer will be a point within this 11 μs RTP window so, even in a perfect system, the measurements may include an error of up to 11 μs.

PTP Phase offset can be affected by network asymmetric delay, which differs for both source and receiver, plus the inherent phase drift of the PTP daemon.

Note: If the underlying media clock is not locked to PTP (for example, if it originates from an SDI player that cannot be generator locked (genlocked) being played through an SDI-to-2110 gateway) then the RTP Offset measurement will have a value that is determined mainly by the video source to PTP timing relationship.

The RTP Offset is a valid measurement for all ST 2110 flows (gapped, linear, wide, narrow) and ST 2022-6 flows that use PTP, where the timing point in ST 2022-6 video is the first active pixel or Frame or Field sync.

Measurements in the Media Latency Tab

Media Latency Measurement

The **Media Latency** measure is the difference between the arrival time of a packet and the time encoded in the RTP timestamp of that packet, averaged over 1 second. This measurement applies to video, ANC, and audio since it does not depend on a frame structure. For video, it applies to the first packet of the frame and is calculated as follows:

$$\text{Latency} = \text{TPA}_0 - \text{RTP}_{\text{Timestamp}} \text{ (averaged over 1 second)}$$

Where:

- **TPA₀** is the arrival PTP time of the first packet of a frame, for progressive video, or field one, for interlaced video, as measured by the unit.
- **RTP_{Timestamp}** is the time contained in the timestamp within the received packet created by the source.

For Video and ANC flows, the RTP timestamp is constant for the entire Frame, so the latency is only measured when the RTP timestamp changes. This occurs on the first packet of a frame for a progressive flow, or field for an interlaced flow, with the results averaged over 1 second.

For Audio flows, as the RTP timestamp increments with each audio packet the latency is measured for every packet with the results averaged over 1 second.

This measurement will be affected by:

- The Sender Encapsulation Time (packet time)
- PTP Lock and Phase Offset of the Sender and unit (Receiver)
- Network propagation delay
- The relationship of the underlying Media Clock to PTP and whether the media is locked to PTP.

This is an indication of the true latency of each flow from source to destination and the time difference that a receiver or gateway will need to accommodate in order to co-time the flows. The longest latency of the associated flows is therefore the minimum co-timed delay through the network.

The PTP time of **TPA₀** is calculated by the receiving hardware timestamp and is not limited by the RTP or Media Clock rate. This timestamp has a resolution of approximately 100 ns and the measurement varies with the PTP estimated phase offset, and the PTP delay control.

The PTP time of the **RTP_{Timestamp}** is limited by the resolution of the source RTP Media Clock. For ST 2110-20 Video and ST 2110-40 ANC this clock is 90 kHz and has a quantization of 11 μs. The true PTP time at which a packet is assembled in the sender output buffer will be a point within this 11 μs RTP window so, even in a perfect system, the measurements may include an error of up to 11 μs.

For ST 2110-30 and ST 2110-31 Audio the Media Clock is 48 kHz and the measurement error increases to 20.8 μs. For an audio packet time of 1 ms this equates to an uncertainty of 2 %, however, a 125 μs audio packet time increases the uncertainty to 16.64 %.

When measuring Audio and ANC to Video timing these RTP timing errors are compounded and are at the limits of the 2110 system.

PTP Phase offset can be affected by network asymmetric delay that differs for the source and receiver, plus the inherent phase drift of the PTP daemon.

Note: If the underlying Media Clock is not locked to PTP (for example, if it originates from an SDI player that cannot be genlocked being played through an SDI-to-2110 gateway) then the source encapsulator will be forced to add or drop packets in order to accommodate the differences in time-bases and this will manifest itself as a change in the nominal 90 kHz or 48 kHz RTP ticks and measured latency. In this case, you will notice that the measured latency value will cyclically and slowly increment or decrement and then jump back.

Note: If the source is not locked to PTP, then the latency measurement will continuously drift.

RTP Clock and Timestamps

IP media systems apply the concepts of the **Media Clock**, the **RTP Clock** and the **RTP Timestamp**.

The **Media clock** is a clock, defined in SMPTE ST 2110-10 to be frequency-locked to PTP, and it advances at an exact rate for each type of media essence. This is not necessarily the same as the Media sampling clock, for example, 74.25 or 74.25/1.001 MHz for HD Video, but happens to be the same for 48 kHz sampled PCM Audio.

The **RTP clock** is the clock used to derive the RTP Timestamp carried in the RTP packet header. The RTP timestamp increments at the rate of the RTP clock, and the timestamp has a value of zero, the SMPTE Epoch defined in ST 2059-1, which is the same as the PTP Epoch defined in IEEE 1588-2008. For reference, the SMPTE Epoch is defined as midnight International Atomic Time (TAI) on the 01 January 1970 [1970-0101T00:00:00TAI] and is 63092010 seconds before the UTC Epoch 1972-01-01T00:00:00Z (UTC), that is, PTP time is not the same as UTC time.

The RTP Clock is defined to be identical to its associated Media Clock in ST 2110-10.

The RTP (or Media) Clock rates are defined in the SMPTE standards ST 2110-20 (Video), ST 2110-30 and ST 2110-31 (Audio) and ST 2110-40 (ANC), and are listed in the following table:

Table B-3 : RTP Clock Rates for ST 2110-20, -30, -31 and -40

Media Essence Type	SMPTE Standard	RTP/Media Clock Rate
Video	ST 2110-20	90 kHz
Audio	ST 2110-30/31	48 kHz
ANC	ST 2110-40	90 kHz

The Video and ANC Media/RTP clock rate is constant for all video frame rates and should not change even with 1000/1001 non-integer frame rates.

The unit measures the actual value of the RTP clock averaged over 1 second and reports the value in the **RTP clks** data column. If the reported values do not match the specified values, this is an indication that either media flows or the sender is not correctly locked to PTP.

While the Video and ANC Media/RTP clock rate is 90 kHz (that is, the value of the timestamp increments every 11.111... μ s) the value of the RTP Timestamp is chosen to be a constant for an entire video frame and is analogous to the timecode of that frame. The chosen timestamp value for the frame is the nearest value of the 90 kHz derived timestamp at the start of the frame.

Video and ANC Timestamps/Second (TS/s)

The unit measures the received number of unique timestamps per second for each media essence type and updates the reported value every second in the **TSs** data column. The measured number of unique timestamps in each second will be an integer value.

For example, for a video or ANC flow with a frame rate of 50 Hz there will be 50 unique timestamps per second.

Audio Timestamps/Second (TS/s)

For Audio flows conforming to ST 2110-30 and ST 2110-31, the number of unique timestamps per second will vary with the audio packet time. This version of software supports Audio packet times of 1 ms and 125 μ s, as shown in the following table:

Table B-4 : Audio Timestamps per Second

Audio Packet Time	Unique Timestamps per Second (TS/s)
1 ms	1000
125 μ s	8000

RTP Clocks per Timestamp Quotient (RTP / TS)

The RTP / TS quotient is a measure of the number of RTP Clocks per Timestamp and is reported by the unit in the **RTP clks/TS** data column. For Video and ANC flows, the number of RTP clocks per timestamp will vary with the video frame rate. The nominal values are shown in the following table:

Table B-5 : Nominal RTP Clocks per Timestamp for Video

Video Frame Rate (Hz)	RTP Clocks per Time Stamp (RTP/TS)
60	1500
59.94	1501.5
50	1800
30	3000
29.97	3003

Video Frame Rate (Hz)	RTP Clocks per Time Stamp (RTP/TS)
25	3600
24	3750
23.98	3753.75

For Audio flows the number of RTP clocks/Timestamp will vary with the Audio Packet Time, and is equal to the number of audio samples per packet. For 48 kHz sampled audio the relationship between the Audio Packet Time and the RTP Clocks per timestamp per second is shown in the following table:

Table B-6 : Nominal RTP Clocks per Timestamp for Audio

Audio Packet Time	RTP Clocks per timestamp (RTP / TS)
1 ms	48
125 μ s	6

Working with Non-integer Frame Rates

For non-integer Video and ANC frame rates such as 60/1.001 (59.94 Hz) the unit receives 60 unique timestamps for 15 or 16 seconds, followed by one second that will contain 59 unique timestamps. For a 59.94 Hz system, the unit will, therefore, report 60 TS/s for 15 or 16 seconds followed by 59 TS/s for one second, resulting in a long-term average of 59.94 TS/s.

Similarly, the measured Video and ANC RTP/Media clock rate for a 59.94 Hz system will be 90,090 Hz (90,000 * 1.001) for 15 or 16 seconds, followed by a single second where the measured RTP Clock will be 88688 Hz or 88687 Hz, resulting in a long-term average of 90,000 Hz.

The reported number of RTP clocks per timestamp will also typically move away from the long-term nominal value for one second. The typical combination of measured values for the RTP Clock Rate, Timestamps/s and RTP Clocks per Timestamp for non-integer Frame and Field rates are given in the following table:

Table B-7 : Typical Reported RTP Clocks per Timestamp for Fractional Frame and Field Rates

Frame or Field Rate (Hz)	Reported RTP/Media Clock Rate	Reported Timestamps per Second (TS/s)	RTP Clocks per Timestamp (RTP/TS)	Interval(s)
60	90,000	60	1500	N/A
59.94	90,090	60	1501.5	16 or 17
	88,588	59	1501.49	
	88,589	59	1501.51	
50	90,000	50	1800	N/A
30	90,000	30	3000	N/A
29.97	90,090	30	3003	33 or 34

Frame or Field Rate (Hz)	Reported RTP/Media Clock Rate	Reported Timestamps per Second (TS/s)	RTP Clocks per Timestamp (RTP/TS)	Interval(s)
	87,087	29	3003	
25	90,000	25	3600	N/A
24	90,000	24	3750	N/A
23.98	90,090	24	3753.75	41 or 42
	86,336	23	3753.74	
	86,337	23	3753.76	

Un-locked Media Sources

It is possible to a situation where the 2110 Sender is locked to PTP, but the underlying media source of Video, Audio, ANC (for example, originating from a free-running SDI player being passed through an SDI-to-2110 gateway with no synchronizer) is not locked to PTP.

In this case, the reported media clock rate for the video, audio and ANC flows will not match any of the expected values shown in the previous table. In addition, the average latency measurement will go through a cyclical sequence where the latency will first increment, then jump back and repeat the cycle.

Sources Not Locked to PTP

When the sending device is not locked to PTP, the value of the latency measurement will drift continuously. This is over and above any cyclical behavior resulting from the underlying media not being locked to PTP.



On-going Development

PHABRIX is committed to developing the toolsets available on the unit, including upgrades to existing instruments and the introduction of new instruments. Please do not hesitate to contact PHABRIX at any time to discuss your requirements for the product or current product timelines.

SMPTE SDTV and UHDTV: SDI Physical Layer Tolerances

The unit will automatically measure the SMPTE SDTV and UHDTV tolerances listed in the following table:

Table C-1: SMPTE SDTV and UHDTV Tolerances

Data Rate	0.270 Gbps	1.485 Gbps	2.97 Gbps	5.94 Gbps	11.88 Gbps
Standard	SMPTE ST259:2008	SMPTE ST292-1:2012	SMPTE ST424:2012	SMPTE ST2081-1, 10	SMPTE SMPTE ST2082-1, 10
Coding	Scrambled NRZI	Scrambled NRZI	Scrambled NRZI	Scrambled NRZI	Scrambled NRZI
Amplitude	800 mV ± 10 %	800 mV ± 10 %	800 mV ± 10 %	800 mV ± 10 %	800 mV ± 10 %
DC Offset	0.0 V ± 0.5 V	0.0 V ± 0.5 V	0.0 V ± 0.5 V	0.0 V ± 0.5 V	0.0 V ± 0.5 V
Rise/Fall Time	< 1500 ps	< 270 ps	< 135 ps	< 80 ps	< 45 ps
Rise/Fall Time Difference	< 500 ps	< 100 ps	< 50 ps	< 35 ps	< 18 ps
Rise/Fall Overshoot	< 10 % of Amplitude	< 10 % of Amplitude	< 10 % of Amplitude	< 10 % of Amplitude	< 10 % of Amplitude
Timing Jitter	< 0.2 UI (10 Hz to 27 MHz)	< 1 UI (10 Hz to 148.5 MHz)	< 2 UI (10 Hz to 297 MHz)	< 4 UI (10 Hz to 594 MHz)	< 8 UI (10 Hz to 1188 MHz)
Alignment Jitter	< 0.2 UI (100 kHz to 27 MHz)	< 0.2 UI (100 kHz to 148.5 MHz)	< 0.3 UI (100 kHz to 297 MHz)	< 0.3 UI (100 kHz to 594 MHz)	< 0.3 UI (100 kHz to 1188 MHz)
75 ohm Coaxial Cable Length (Belden 1694A)	400 m	200 m	200 m	100 m	70 m

The complexity of both analyzing and generating signals for SDTV and UHDTV is exemplified in the above table. The data bandwidth testing from SD and HD through to UHDTV at 12 Gbps, standard on the unit, is immense and the parameters set by SMPTE require that the instruments measure these critical values for compliance.

Supported SFPs

For information on the SFPs supported by the current software version, please contact PHABRIX Support at:

- www.phabrix.com/support

Supported Video Standards

Please contact PHABRIX if you require support for any standards not listed here. The current software version supports the following standards:

SD/HD/2K Supported Formats

The following ST 2022-6 formats are supported:

Table D-1 : Supported SD/HD/2K Video Standards (IP 2022-6 and SDI (Optional) Input)

SMPTE Stnds. Link (Content)	Interface	Resolution	Sampling Structure	Pixel Depth	Frame / Field Rate	SDI-HDR	SDI-SDR	2022-6
ST 259 (ST 125)	SD (525i)	720 x 485	4:2:2 (YCbCr)	10	59.94i	-	A	○ A
ST 259 (ST 125)	SD (625i)	720 x 576	4:2:2 (YCbCr)	10	50i	-	A	○ A
ST 292 (ST 296)	HD	1280 x 720	4:2:2 (YCbCr)	10	60p, 59.94p, 50p, 30p, 29.97p, 25p	○ ●	●	●
ST 292 (ST 274)	HD	1920 x 1080	4:2:2 (YCbCr)	10	60i, 59.94i, 50i, 30p, 29.97p, 25p, 24p, 23.98p	○ ●	●	●
ST 292 (RP 211)	HD	1920 x 1080	4:2:2 (YCbCr)	10	30PsF, 29.97PsF, 25PsF, 24PsF, 23.98PsF	○ ●	●	●
ST 292 (ST 2048-2)	HD	2048 x 1080	4:2:2 (YCbCr)	10	30p, 29.97p, 25p, 24p, 23.98p 30PsF, 29.97PsF, 25PsF, 24PsF, 23.98PsF	○ ●	●	●
ST 372 (ST 274)	Dual Link HD	1920 x 1080	4:2:2 (YCbCr)	10	60p, 59.94p, 50p	○ ●	●	-
ST 372 (ST 274)	Dual Link HD	1920 x 1080	4:4:4 (YCbCr/RGB) 4:4:4:4 (YCbCrA/RGBA)	10	60i, 59.94i, 50i 30PsF, 29.97PsF, 25PsF, 24PsF, 23.98PsF 30p, 29.97p, 25p, 24p, 23.98p	○ ●	●	-
ST 372 (ST 274)	Dual Link HD	1920 x 1080	4:4:4 (YCbCr/RGB)	12	60i, 59.94i, 50i 30p, 29.97p, 25p, 24p, 23.98p	○ ●	●	-
ST 372 (ST 274)	Dual Link HD	1920 x 1080	4:2:2 (YCbCr)	12	60i, 59.94i, 50i 30PsF, 29.97PsF, 25PsF, 24PsF, 23.98PsF 30p, 29.97p, 25p, 24p, 23.98p	○ ●	●	-

SMPTE Stnds. Link (Content)	Interface	Resolution	Sampling Structure	Pixel Depth	Frame / Field Rate	SDI-HDR	SDI-SDR	2022-6
ST 372 (ST 274)	Dual Link HD	2048 x 1080	4:2:2 (YCbCr)	10	60p, 59.94p, 50p, 48p, 47.95p	○●	●	-
ST 372 (ST 274)	Dual Link HD	2048 x 1080	4:4:4 (YCbCr/RGB) 4:4:4:4 (YCbCrA/RGBA)	10	30PsF, 29.97PsF, 25PsF, 24PsF, 23.98PsF 30p, 29.97p, 25p, 24p, 23.98p	○●	●	-
ST 372 (ST 274)	Dual Link HD	2048 x 1080	4:4:4 (YCbCr/RGB)	12	30PsF, 29.97PsF, 25PsF, 24PsF, 23.98PsF 30p, 29.97p, 25p, 24p, 23.98p	○●	●	-
ST 372 (ST 274)	Dual Link HD	2048 x 1080	4:2:2 (YCbCr) 4:2:2:4 (YCbCrA)	12	30PsF, 29.97PsF, 25PsF, 24PsF, 23.98PsF 30p, 29.97p, 25p, 24p, 23.98p	○●	●	-
ST 425-1 (ST 274)	3G Level A (I)	1920 x 1080	4:2:2 (YCbCr)	10	60p, 59.94p, 50p	○●	●	●
ST 425-1 (ST 2048-2)	3G Level A (I)	2048 x 1080	4:2:2 (YCbCr)	10	60p, 59.94p, 50p, 48p, 47.95p	○●	●	●
ST 425-1 (ST 296)	3G Level A (2)	1280 x 720	4:4:4 (YCbCr/RGB) 4:4:4:4 (YCbCrA/RGBA)	10	60p, 59.94p, 50p, 30p, 29.97p	○●	●	●
ST 425-1 (ST 274)	3G Level A (2)	1920 x 1080	4:4:4 (YCbCr/RGB) 4:4:4:4 (YCbCrA/RGBA)	10	60i, 59.94i, 50i 30psF, 29.97psF, 25psF, 24psF, 23.98psF 30p, 29.97p, 25p, 24p, 23.98p	○●	●	●
ST 425-1 (ST 2048-2)	3G Level A (2)	2048 x 1080	4:4:4 (YCbCr/RGB) 4:4:4:4 (YCbCrA/RGBA)	10	30psF, 29.97psF, 25psF, 24psF, 23.98psF 30p, 29.97p, 25p, 24p, 23.98p	○●	●	●
ST 425-1 (ST 274)	3G Level A (3)	1920 x 1080	4:4:4 (YCbCr/RGB)	12	60i, 59.94i, 50i 30p, 29.97p, 25p, 24p, 23.98p	○●	●	●
ST 425-1 (ST 2048-2)	3G Level A (3)	2048 x 1080	4:4:4 (YCbCr/RGB)	12	30psF, 29.97psF, 25psF, 24psF, 23.98psF 30p, 29.97p, 25p, 24p, 23.98p	○●	●	●
ST 425-1 (ST 274)	3G Level A (4)	1920 x 1080	4:2:2 (YCbCr)	12	60i, 59.94i, 50i 30p, 29.97p, 25p, 24p, 23.98p 30psF, 29.97psF, 25psF, 24psF, 23.98psF	○●	●	●
ST 425-1 (ST 2048-2)	3G Level A (4)	2048 x 1080	4:2:2 (YCbCr) 4:2:2:4 (YCbCrA)	12	30p, 29.97p, 25p, 24p, 23.98p, 30psF, 29.97psF, 25psF, 24psF, 23.98psF	○●	●	●
ST 425-1 (ST 274)	3G Level B-DL (I)	1920 x 1080	4:2:2 (YCbCr)	10	60p, 59.94p, 50p	○●	●	●
ST 425-1 (ST 2048-2)	3G Level B-DL (I)	2048 x 1080	4:2:2 (YCbCr)	10	60p, 59.94p, 50p, 48p, 47.95p	○●	●	●
ST 425-1 (ST 274)	3G Level B-DL (II)	1920 x 1080	4:4:4 (YCbCr/RGB) 4:4:4:4 (YCbCrA/RGBA)	10	60i, 59.94i, 50i 30PsF, 29.97PsF, 25PsF, 24PsF, 23.98PsF 30p, 29.97p, 25p, 24p, 23.98p	○●	●	●
ST 425-1 (ST 2048-2)	3G Level B-DL (II)	2048 x 1080	4:4:4 (YCbCr/RGB) 4:4:4:4 (YCbCrA/RGBA)	10	30PsF, 29.97PsF, 25PsF, 24PsF, 23.98PsF 30p, 29.97p, 25p, 24p, 23.98p	○●	●	●
ST 425-1 (ST 274)	3G Level B-DL (III)	1920 x 1080	4:4:4 (YCbCr/RGB)	12	60i, 59.94i, 50i 30p, 29.97p, 25p, 24p, 23.98p	○●	●	●
ST 425-1 (ST 2048-2)	3G Level B-DL (III)	2048 x 1080	4:4:4 (YCbCr/RGB)	12	30PsF, 29.97PsF, 25PsF, 24PsF, 23.98PsF 30p, 29.97p, 25p, 24p, 23.98p	○●	●	●
ST 425-1 (ST 274)	3G Level B-DL (IV)	1920 x 1080	4:2:2 (YCbCr)	12	60i, 59.94i, 50i 30PsF, 29.97PsF, 25PsF, 24PsF, 23.98PsF 30p, 29.97p, 25p, 24p, 23.98p	○●	●	●
ST 425-1 (ST 2048-2)	3G Level B-DL (IV)	2048 x 1080	4:2:2 (YCbCr) 4:2:2:4 (YCbCrA)	12	30PsF, 29.97PsF, 25PsF, 24PsF, 23.98PsF 30p, 29.97p, 25p, 24p, 23.98p	○●	●	●

Key to table:

- ● - Generator with Option **PHQXLO-GEN** and Analyzer
- ○ - Optional
- **A** - Analyzer Only
- -- Not Supported

Table D-2 : Supported SD/HD/2K Video Standards (ST 2110 IP Input)

Resolution	Sampling Structure	Pixel Depth	Frame / Field Rate	QxL	
				2110-HDR	2110-SDR
720 x 485	4:2:2 (YCbCr)	10	59.94i	-	○ A
720 x 576	4:2:2 (YCbCr)	10	50i	-	○ A
1280 x 720	4:2:2 (YCbCr)	8	60p, 59.94p, 50p, 48p, 47.97p, 30p, 29.97p, 25p, 24p, 23.98p	○ A	A
1280 x 720	4:2:2 (YCbCr)	10	60p, 59.94p, 50p, 48p, 47.97p, 30p, 29.97p, 25p, 24p, 23.97p	○ ●	●
1280 x 720	4:4:4(YCbCr/RGB)	8	60p, 59.94p, 50p, 48p, 47.97p, 30p, 29.97p, 25p, 24p, 23.98p	○ A	A
1280 x 720	4:4:4(YCbCr/RGB)	10	60p, 59.94p, 50p, 48p, 47.97p, 30p, 29.97p, 25p, 24p, 23.98p	○ ●	●
1920 x 1080	4:2:2 (YCbCr)	8	60i, 59.94i, 50i	○ A	A
1920 x 1080	4:2:2 (YCbCr)	10	60i, 59.94i, 50i	○ ●	●
1920 x 1080	4:2:2 (YCbCr)	12	60i, 59.94i, 50i	○ ●	●
1920 x 1080	4:4:4(YCbCr/RGB)	8	60i, 59.94i, 50i	○ A	A
1920 x 1080	4:4:4(YCbCr/RGB)	10	60i, 59.94i, 50i	○ ●	●
1920 x 1080	4:4:4(YCbCr/RGB)	12	60i, 59.94i, 50i	○ ●	●
1920 x 1080	4:2:2 (YCbCr)	8	60p, 59.94p, 50p, 48p, 47.97p, 30p, 29.97p, 25p, 24p, 23.98p	○ A	A
1920 x 1080	4:2:2 (YCbCr)	10	60p, 59.94p, 50p, 48p, 47.97p, 30p, 29.97p, 25p, 24p, 23.98p	○ ●	●
1920 x 1080	4:2:2 (YCbCr)	12	60p, 59.94p, 50p, 48p, 47.97p, 30p, 29.97p, 25p, 24p, 23.98p	○ ●	●
1920 x 1080	4:4:4(YCbCr/RGB)	8	60p, 59.94p, 50p, 48p, 47.97p, 30p, 29.97p, 25p, 24p, 23.98p	○ A	A
1920 x 1080	4:4:4(YCbCr/RGB)	10	60p, 59.94p, 50p, 48p, 47.97p, 30p, 29.97p, 25p, 24p, 23.98p	○ ●	●
1920 x 1080	4:4:4(YCbCr/RGB)	12	60p, 59.94p, 50p, 48p, 47.97p, 30p, 29.97p, 25p, 24p, 23.98p	○ ●	●
1920 x 1080	4:2:2 (YCbCr)	8	30psF, 29.97PsF, 25PsF, 24PsF, 23.97PsF	○ A	A
1920 x 1080	4:2:2 (YCbCr)	10	30psF, 29.97PsF, 25PsF, 24PsF, 23.97PsF	○ A	A
1920 x 1080	4:2:2 (YCbCr)	12	30psF, 29.97PsF, 25PsF, 24PsF, 23.97PsF	○ A	A
1920 x 1080	4:4:4(YCbCr/RGB)	8	30psF, 29.97PsF, 25PsF, 24PsF, 23.97PsF	○ A	A
1920 x 1080	4:4:4(YCbCr/RGB)	10	30psF, 29.97PsF, 25PsF, 24PsF, 23.97PsF	○ A	A
1920 x 1080	4:4:4(YCbCr/RGB)	12	30psF, 29.97PsF, 25PsF, 24PsF, 23.97PsF	○ A	A
2048 x 1080	4:2:2 (YCbCr)	8	60p, 59.94p, 50p, 48p, 47.97p, 30p, 29.97p, 25p, 24p, 23.98p	○ A	A
2048 x 1080	4:2:2 (YCbCr)	10	60p, 59.94p, 50p, 48p, 47.97p, 30p, 29.97p, 25p, 24p, 23.98p	○ ●	●
2048 x 1080	4:2:2 (YCbCr)	12	60p, 59.94p, 50p, 48p, 47.97p, 30p, 29.97p, 25p, 24p, 23.98p	○ ●	●
2048 x 1080	4:4:4(YCbCr/RGB)	8	60p, 59.94p, 50p, 48p, 47.97p, 30p, 29.97p, 25p, 24p, 23.98p	○ A	A

Resolution	Sampling Structure	Pixel Depth	Frame / Field Rate	QxL	
				2110-HDR	2110-SDR
2048 x 1080	4:4:4(YCbCr/RGB)	10	60p, 59.94p, 50p, 48p, 47.97p, 30p, 29.97p, 25p, 24p, 23.98p	○ ●	●
2048 x 1080	4:4:4(YCbCr/RGB)	12	60p, 59.94p, 50p, 48p, 47.97p, 30p, 29.97p, 25p, 24p, 23.98p	○ ●	●
2048 x 1080	4:2:2 (YCbCr)	8	30psF, 29.97PsF, 25PsF, 24PsF, 23.97PsF	○ A	A
2048 x 1080	4:2:2 (YCbCr)	10	30psF, 29.97PsF, 25PsF, 24PsF, 23.97PsF	○ A	A
2048 x 1080	4:2:2 (YCbCr)	12	30psF, 29.97PsF, 25PsF, 24PsF, 23.97PsF	○ A	A
2048 x 1080	4:4:4(YCbCr/RGB)	8	30psF, 29.97PsF, 25PsF, 24PsF, 23.97PsF	○ A	A
2048 x 1080	4:4:4(YCbCr/RGB)	10	30psF, 29.97PsF, 25PsF, 24PsF, 23.97PsF	○ A	A
2048 x 1080	4:4:4(YCbCr/RGB)	12	30psF, 29.97PsF, 25PsF, 24PsF, 23.97PsF	○ A	A

Key to table:

- - Generator with Option **PHQXLO-GEN** and Analyzer
- - Optional
- A** - Analyzer Only
- Not Supported

4K/UHD Supported Formats

Table D-3 : Supported 4K/UHD SDI Video Standards

SMPTE Stnds. Link (Content)	Interface	Resolution	Sampling Structure	Pixel Depth	Frame / Field Rate	SDI-HDR	SDI-SDR
ST 425-3 Annex B.1 (ST 2036-1)	Quad-link HD-SQ	3840 x 2160	4:2:2 (YCbCr)	10	30p, 29.97p, 25p, 24p, 23.98p	○ ●	○
ST 425-3 Annex B.1 (ST 2048-1)	Quad-link HD-SQ	4096 x 2160	4:2:2 (YCbCr)	10	30p, 29.97p, 25p, 24p, 23.98p	○ ●	○
ST 425-3 Annex B.2 (ST 2036-1)	Dual 3G-B-DS	3840 x 2160	4:2:2 (YCbCr)	10	30p, 29.97p, 25p, 24p, 23.98p	○ ●	○
ST 425-3 Annex B.2 (ST 2048-1)	Dual 3G-B-DS	4096 x 2160	4:2:2 (YCbCr)	10	30p, 29.97p, 25p, 24p, 23.98p	○ ●	○
ST 2081-10 M1 (ST 2036-1)	6G-2SI	3840 x 2160	4:2:2 (YCbCr)	10	30p, 29.97p, 25p, 24p, 23.98p	○ ●	○
ST 2081-10 M1 (ST 2048-1)	6G-2SI	4096 x 2160	4:2:2 (YCbCr)	10	30p, 29.97p, 25p, 24p, 23.98p	○ ●	○
ST 425-5 (ST 2036-1)	Quad-link 3G-A (1) 2SI	3840 x 2160	4:2:2 (YCbCr)	10	60p, 59.94p, 50p	○ ●	○
ST 425-5 (ST 2048-1)	Quad-link 3G-A (1) 2SI	4096 x 2160	4:2:2 (YCbCr)	10	60p, 59.94p, 50p, 48p, 47.95p	○ ●	○
ST 425-5 (ST 2036-1)	Quad-link 3G-A (2) 2SI	3840 x 2160	4:4:4 (YCbCr/RGB)	10	30p, 29.97p, 25p, 24p, 23.98p	○ ●	○
ST 425-5 (ST 2048-1)	Quad-link 3G-A (2) 2SI	4096 x 2160	4:4:4 (YCbCr/RGB) 4:4:4:4 (YCbCrA/RGBA)	10	30p, 29.97p, 25p, 24p, 23.98p	○ ●	○
ST 425-5 (ST 2036-1)	Quad-link 3G-A (3) 2SI	3840 x 2160	4:4:4 (YCbCr/RGB)	12	30p, 29.97p, 25p, 24p, 23.98p	○ ●	○
ST 425-5 (ST 2048-1)	Quad-link 3G-A (3) 2SI	4096 x 2160	4:4:4 (YCbCr/RGB)	12	30p, 29.97p, 25p, 24p, 23.98p	○ ●	○
ST 425-5 (ST 2036-1)	Quad-link 3G-A (4) 2SI	3840 x 2160	4:2:2 (YCbCr)	12	30p, 29.97p, 25p, 24p, 23.98p	○ ●	○
ST 425-5 (ST 2048-1)	Quad-link 3G-A (4) 2SI	4096 x 2160	4:2:2 (YCbCr) 4:2:2:4 (YCbCrA)	12	30p, 29.97p, 25p, 24p, 23.98p	○ ●	○
ST 425-5 Annex B (ST 2036-1)	Quad-link 3G-A, B (1) SQ	3840 x 2160	4:2:2 (YCbCr)	10	60p, 59.94p, 50p	○ ●	○
ST 425-5 Annex B (ST 2048-1)	Quad-link 3G-A, B (1) SQ	4096 x 2160	4:2:2 (YCbCr)	10	60p, 59.94p, 50p, 48p, 47.95p	○ ●	○
ST 425-5 Annex B (ST 2036-1)	Quad-link 3G-A, B (2) SQ	3840 x 2160	4:4:4 (YCbCr/RGB)	10	30p, 29.97p, 25p, 24p, 23.98p	○ ●	○
ST 425-5 Annex B (ST 2048-1)	Quad-link 3G-A, B (2) SQ	4096 x 2160	4:4:4 (YCbCr/RGB) 4:4:4:4 (YCbCrA/RGBA)	10	30p, 29.97p, 25p, 24p, 23.98p	○ ●	○
ST 425-5 Annex B (ST 2036-1)	Quad-link 3G-A, B (3) SQ	3840 x 2160	4:4:4 (YCbCr/RGB)	12	30p, 29.97p, 25p, 24p, 23.98p	○ ●	○
ST 425-5 Annex B (ST 2048-1)	Quad-link 3G-A, B (3) SQ	4096 x 2160	4:4:4 (YCbCr/RGB)	12	30p, 29.97p, 25p, 24p, 23.98p	○ ●	○
ST 425-5 Annex B (ST 2036-1)	Quad-link 3G-A (4) SQ	3840 x 2160	4:2:2 (YCbCr)	12	30p, 29.97p, 25p, 24p, 23.98p	○ ●	○
ST 425-5 Annex B (ST 2048-1)	Quad-link 3G-A (4) SQ	4096 x 2160	4:2:2 (YCbCr) 4:2:2:4 (YCbCrA)	12	30p, 29.97p, 25p, 24p, 23.98p	○ ●	○
ST 2081-11 M1, ST 425-5 (ST 2036-1)	Dual-link 6G-2SI (I)	3840 x 2160	4:2:2 (YCbCr)	10	60p, 59.94p, 50p	○ ●	○
ST 2081-11 M1, ST 425-5 (ST 2048-1)	Dual-link 6G-2SI (I)	4096 x 2160	4:2:2 (YCbCr)	10	60p, 59.94p, 50p, 48p, 47.95p	○ ●	○
ST 2081-11 M1, ST 425-5 (ST 2036-1)	Dual-link 6G-2SI (II)	3840 x 2160	4:4:4 (YCbCr/RGB)	10	30p, 29.97p, 25p, 24p, 23.98p	○ ●	○

SMPTE Stnds. Link (Content)	Interface	Resolution	Sampling Structure	Pixel Depth	Frame / Field Rate	SDI-HDR	SDI-SDR
ST 2081-11 M1, ST 425-5 (ST 2048-1)	Dual-link 6G-2SI (II)	4096 x 2160	4:4:4 (YCbCr/RGB) 4:4:4:4 (YCbCrA/RGBA)	10	30p, 29.97p, 25p, 24p, 23.98p	○ ●	○
ST 2081-11 M1 ST 425-5 (ST 2036-1)	Dual-link 6G-2SI (III)	3840 x 2160	4:4:4 (YCbCr/RGB)	12	30p, 29.97p, 25p, 24p, 23.98p	○ ●	○
ST 2081-11 M1, ST 425-5 (ST 2048-1)	Dual-link 6G-2SI (III)	4096 x 2160	4:4:4 (YCbCr/RGB)	12	30p, 29.97p, 25p, 24p, 23.98p	○ ●	○
ST 2081-11 M1, ST 425-5 (ST 2036-1)	Dual-link 6G-2SI (IV)	3840 x 2160	4:2:2 (YCbCr)	12	30p, 29.97p, 25p, 24p, 23.98p	○ ●	○
ST 2081-11 M1 ST 425-5 (ST 2048-1)	Dual-link 6G-2SI (IV)	4096 x 2160	4:2:2 (YCbCr) 4:2:2:4 (YCbCrA)	12	30p, 29.97p, 25p, 24p, 23.98p	○ ●	○
ST 2082-10 M1, ST 425-5 (ST 2036-1)	12G-2SI (I)	3840 x 2160	4:2:2 (YCbCr)	10	60p, 59.94p, 50p	○ ●	○
ST 2082-10 M1, ST 425-5 (ST 2048-1)	12G-2SI (I)	4096 x 2160	4:2:2 (YCbCr)	10	60p, 59.94p, 50p, 48p, 47.95p	○ ●	○
ST 2082-10 M1 ST 425-5 (ST 2036-1)	12G-2SI (II)	3840 x 2160	4:4:4 (YCbCr/RGB)	10	30p, 29.97p, 25p, 24p, 23.98p	○ ●	○
ST 2082-10 M1 ST 425-5 (ST 2048-1)	12G-2SI (II)	4096 x 2160	4:4:4 (YCbCr/RGB) 4:4:4:4 (YCbCrA/RGBA)	10	30p, 29.97p, 25p, 24p, 23.98p	○ ●	○
ST 2082-10 M1 ST 425-5 (ST 2036-1)	12G-2SI (III)	3840 x 2160	4:4:4 (YCbCr/RGB)	12	30p, 29.97p, 25p, 24p, 23.98p	○ ●	○
ST 2082-10 M1 ST 425-5 (ST 2048-1)	12G-2SI (III)	4096 x 2160	4:4:4 (YCbCr/RGB)	12	30p, 29.97p, 25p, 24p, 23.98p	○ ●	○
ST 2082-10 M1 ST 425-5 (ST 2036-1)	12G-2SI (IV)	3840 x 2160	4:2:2 (YCbCr) 4:2:2:4 (YCbCrA)	12	30p, 29.97p, 25p, 24p, 23.98p	○ ●	○
ST 2082-10 M1 ST 425-5 (ST 2048-1)	12G-2SI (IV)	4096 x 2160	4:2:2 (YCbCr) 4:2:2:4 (YCbCrA)	12	30p, 29.97p, 25p, 24p, 23.98p	○ ●	○

Key to table:

- - Generator with Option **PHQXLO-GEN** and Analyzer
- - Optional

Table D-4 : Supported 4K/UHD ST 2110 IP Video Standards (Requires Option: PHQXLO-UHD)

Resolution	Sampling Structure	Pixel Depth	Frame / Field Rate	2110-HDR	2110-SDR
3840 x 2160	4:2:2 (YCbCr)	8	60p, 59.94p, 50p, 48p, 47.97p, 30p, 29.97p, 25p, 24p, 23.98p	○ A	A
3840 x 2160	4:2:2 (YCbCr)	10	60p, 59.94p, 50p, 48p, 47.97p, 30p, 29.97p, 25p, 24p, 23.98p	○ ●	●
3840 x 2160	4:2:2 (YCbCr)	12	60p, 59.94p, 50p, 48p, 47.97p, 30p, 29.97p, 25p, 24p, 23.98p	○ ●	●
3840 x 2160	4:4:4(YCbCr/RGB)	8	30p, 29.97p, 25p, 24p, 23.98p	○ A	A
3840 x 2160	4:4:4(YCbCr/RGB)	10	30p, 29.97p, 25p, 24p, 23.98p	○ ●	●
3840 x 2160	4:4:4(YCbCr/RGB)	12	30p, 29.97p, 25p, 24p, 23.98p	○ ●	●
4096 x 2160	4:2:2 (YCbCr)	8	60p, 59.94p, 50p, 48p, 47.97p, 30p, 29.97p, 25p, 24p, 23.98p	○ A	A
4096 x 2160	4:2:2 (YCbCr)	10	60p, 59.94p, 50p, 48p, 47.97p, 30p, 29.97p, 25p, 24p, 23.98p	○ ●	●
4096 x 2160	4:2:2 (YCbCr)	12	60p, 59.94p, 50p, 48p, 47.97p, 30p, 29.97p, 25p, 24p, 23.98p	○ ●	●

Resolution	Sampling Structure	Pixel Depth	Frame / Field Rate	2110-HDR	2110-SDR
			24p, 23.98p		
4096 x 2160	4:4:4(YCbCr/RGB)	8	30p, 29.97p, 25p, 24p, 23.98p	○ A	A
4096 x 2160	4:4:4(YCbCr/RGB)	10	30p, 29.97p, 25p, 24p, 23.98p	○ ●	●
4096 x 2160	4:4:4(YCbCr/RGB)	12	30p, 29.97p, 25p, 24p, 23.98p	○ ●	●

Key to table:

- - Generator with Option **PHQXLO-GEN** and Analyzer
- - Optional
- A - Analyzer Only

Table D-5 : Supported Extended 4K/UHD ST 2110 IP Video Standards (Requires Options: PHQXLO-UHD and PHQXLO-EUHD)

Resolution	Sampling Structure	Pixel Depth	Frame / Field Rate	2110-HDR	2110-SDR
UHD Formats					
3840 x 2160	RGB:444	8	47.95p, 48p, 50p, 59.94p, 60p	○ A	○ A
3840 x 2160	RGB:444	10	47.95p, 48p, 50p, 59.94p, 60p	○ ●	○ ●
3840 x 2160	RGB:444	12	47.95p, 48p, 50p, 59.94p, 60p	○ ●	○ ●
3840 x 2160	YCbCr:444	8	47.95p, 48p, 50p, 59.94p, 60p	○ A	○ A
3840 x 2160	YCbCr:444	10	47.95p, 48p, 50p, 59.94p, 60p	○ ●	○ ●
3840 x 2160	YCbCr:444	12	47.95p, 48p, 50p, 59.94p, 60p	○ ●	○ ●
4K Formats					
4096 x 2160	RGB:444	8	47.95p, 48p, 50p, 59.94p, 60p	○ A	○ A
4096 x 2160	RGB:444	10	47.95p, 48p, 50p, 59.94p, 60p	○ ●	○ ●
4096 x 2160	RGB:444	12	47.95p, 48p, 50p, 59.94p, 60p	○ ●	○ ●
4096 x 2160	YCbCr:444	8	47.95p, 48p, 50p, 59.94p, 60p	○ A	○ A
4096 x 2160	YCbCr:444	10	47.95p, 48p, 50p, 59.94p, 60p	○ ●	○ ●
4096 x 2160	YCbCr:444	12	47.95p, 48p, 50p, 59.94p, 60p	○ ●	○ ●

Key to table:

- - Generator with Option **PHQXLO-GEN** and Analyzer
- - Optional
- A - Analyzer Only



PHABRIX®
A Leader Company

www.phabrix.com



PHABRIX products are continuously being updated
Please visit www.phabrix.com for latest product information